

Assembly Instructions







43152612 UPHOLSTERED BENCH

CARE INSTRUCTIONS: WIPE CLEAN WITH A SOFT DAMP CLOTH. DO NOT USE ABRASIVE MATERIAL AND SOLVENTS. SPOT CLEAN IF NEEDED. KEEP AWAY FROM WATER AND DIRECT SUNLIGHT. STORE IN A DRY PLACE. CHECK AND TIGHTEN ALL PARTS REGULARLY. FOR INDOOR AND DOMESTIC USE ONLY.

WARNING: DO NOT STAND ON THE BENCH. USE ONLY ON A FLAT SURFACE. DO NOT USE UNTIL ALL SCREWS, BOLTS AND KNOBS ARE FIRMLY SECURED. THIS PRODUCT CONTAINS SMALL PARTS AND SHARP POINTS, KEEP AWAY FROM CHILDREN AND BABIES. ADULT ASSEMBLY REQUIRED. FAILURE TO FOLLOW THESE WARNINGS COULD RESULT IN SERIOUS INJURY.

DO NOT TIGHTEN THE SCREWS FULLY DURING ASSEMBLY. FULLY TIGHTEN SCREWS AFTER THE FINAL ASSEMBLY STEPS.

MAXIMUM SAFE LOAD: 200KG.

AX1	BX4	CX8	DX8	EX1	FX8
					

STEP 1

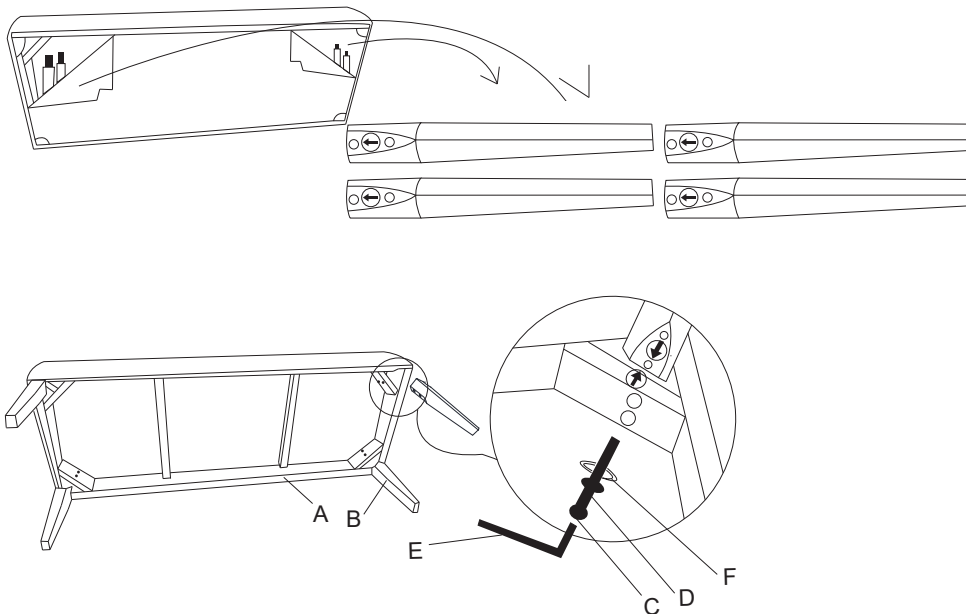

Please pay attention for the direction of leg when attach to the body of bench.

STEP 2

