

43158041 BLAIRE WALL SCONCE WHITE

SLR-21064

IMPORTANT SAFETY INSTRUCTIONS:

The following safety precautions should always be followed, to reduce the risk of electric shock, personal injury or fire. It is important to read all of these instructions carefully before using the product, and to save them for future reference or new users.

1. This product must only be used as intended in accordance with the enclosed operating instructions.
2. Do not carry the appliance by the mains cable or pull the cable to remove the plug from the socket.
3. If the external flexible cable or cord of this luminaire is damaged, it shall be exclusively replaced by the manufacturer or his service agent or a similar qualified person in order to avoid a hazard.
4. If the appliance stops unexpectedly or appears to malfunction, switch off the power supply, unplug from the mains and stop using immediately. Seek professional advice to rectify the fault or make repairs.
5. Switch off the power supply or unplug from the mains socket when not in use, before cleaning or changing accessories.
6. Avoid positioning the appliance where the power cable might be accidentally trapped or damaged.
7. Keep the appliance and cable away from sources of heat, sharp objects or anything that may cause damage.
8. Ensure the appliance is switched OFF before connecting the mains power supply.
9. Be aware that some surfaces may become hot. Do not touch hot surfaces and supervise others accordingly.
10. This product has not been designed for use by children.
11. Children should be closely supervised at all times when they are near any electrical appliance.
12. To protect against electric shock, never allow the appliance, the mains cable or plug to come into contact with water or any other liquid.
13. Never reach for any appliance that has fallen into water. Switch off the power supply at the mains immediately and unplug. Do not re-use until the product has been inspected and approved by a qualified electrician.
14. Always ensure that hands are dry before operating or adjusting any switch on the product or touching the plug and mains supply connections.
15. To disconnect, first ensure that all controls are in the OFF position, then remove the plug from the electricity supply.
16. Where relevant keep all ventilation slots, filters, etc. uncovered and clear of debris. Never drop or insert objects into the openings.
17. Do not use outdoors. This appliance has been designed for domestic indoor use only.



ADDITIONAL SAFETY PRECAUTIONS FOR LIGHTING:

1. Carefully read all instructions for the assembly and use of this item before connecting to an electricity supply.
2. Use only the recommended bulb rating, as detailed on the lamp holder and /or label.
3. Never use a bulb that is rated more than the recommended capacity.
4. Light bulbs become very hot in seconds. Do not attempt to touch the bulb while the lamp is lit and supervise others accordingly.
5. Before cleaning or replacing a defective bulb, switch off the lamp and unplug from the mains socket. Allow the bulb to cool for at least 10 minutes, before touching it and making the change.
6. Ensure the new bulb is secure in the holder before reconnecting to the power supply.
7. If in doubt, consult a qualified electrician.

Product specification

- Rated voltage: 220-240V ~ 50Hz
- This lamp requires: 1x Max 25W E14 Small Edison Screw bulb (Not included)
7-9W LED recommended for medium brightness

Accessories:

		
Expansion bolt	Metal screw	Location hole card
L 30mm	φ4*30mm	100*100mm
3 pcs	3 pcs	1 pc

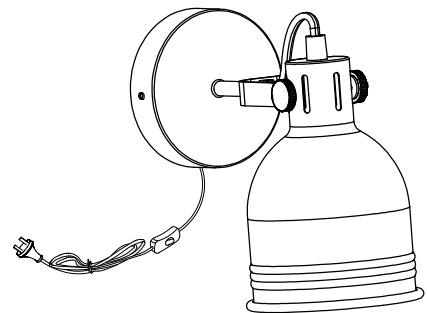

INSTRUCTIONS FOR INSTALLATION:

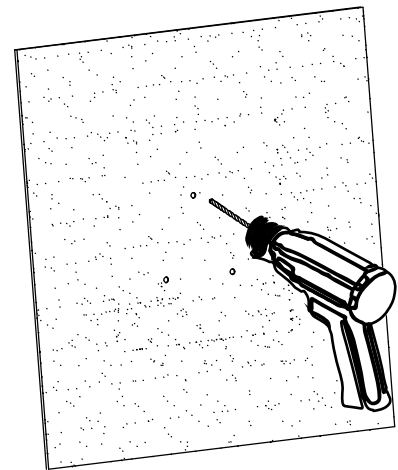
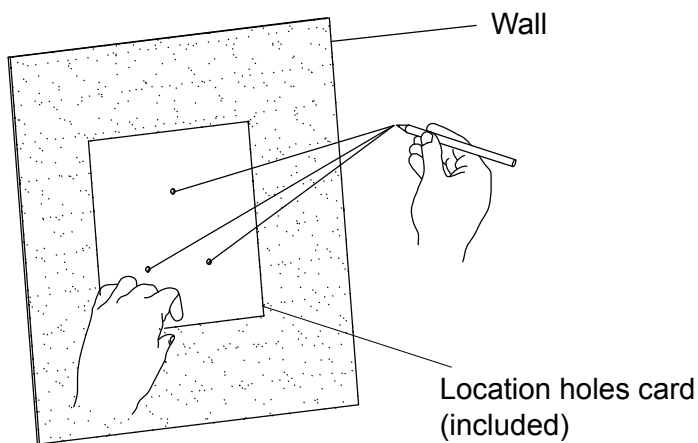

① Put the location holes card on the wall which you would like to hang the lamp. Use pencil or marker pen (not included) to locate 3 holes.

② Drill holes at the located position by pistol drill (not included). Make sure the drill diameter is 5-5.2mm and holes depth are deeper than 30mm.

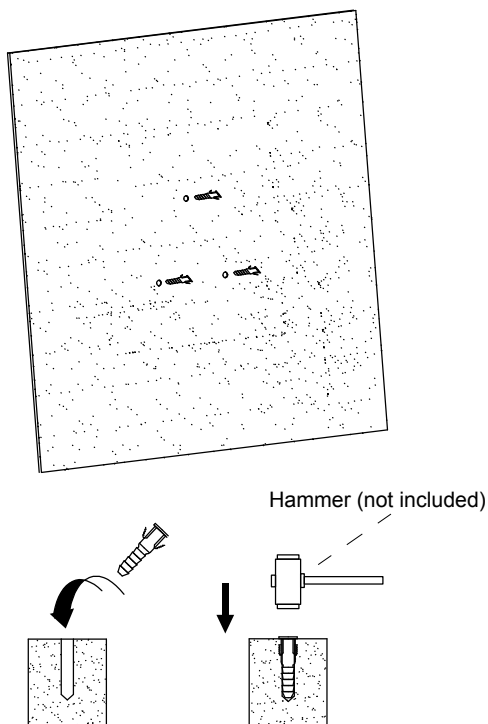

③ Insert the expansion bolts into the holes. Use hammer (not included) to make it smooth on the wall.

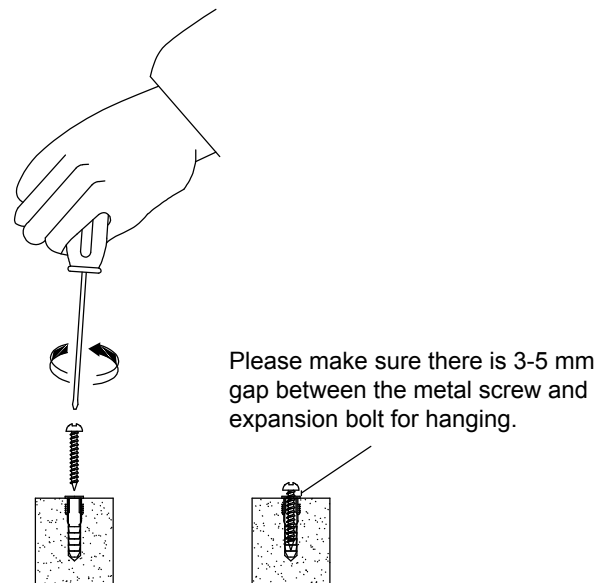

④ Install the metal screws into the expansion bolts. Please make sure there is 3-5mm gap between metal screw and expansion bolt for hanging.

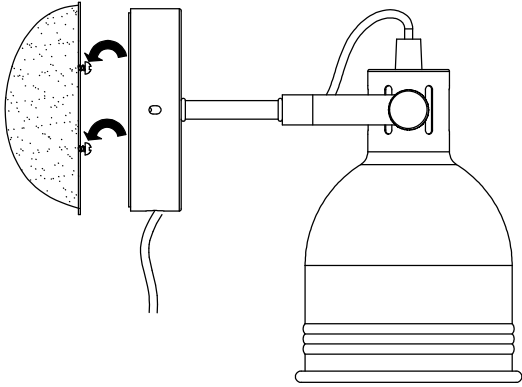

⑤ Hang the lamp on the wall.

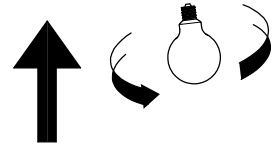
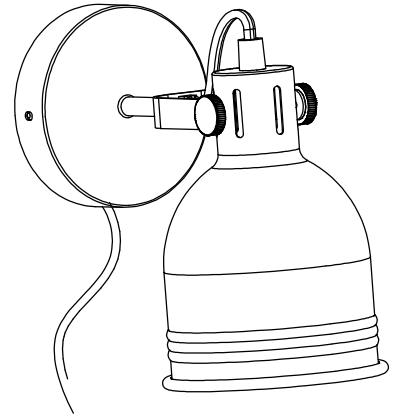

⑥ Install the bulb – Max 25W E14 Small Edison Screw(not included) into the lamp holder.

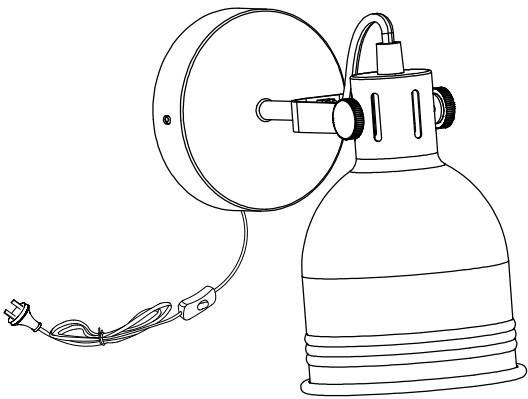

⑦ Check to ensure that all the components have been assembled correctly. Connect to the mains supply.

12 Month Warranty

Thank you for your purchase from Kmart.

Kmart Australia Ltd warrants your new product to be free from defects in materials and workmanship for the period stated above, from the date of purchase, provided that the product is used in accordance with accompanying recommendations or instructions where provided. This warranty is in addition to your rights under the Australian Consumer Law.

Kmart will provide you with your choice of a refund, repair or exchange (where possible) for this product if it becomes defective within the warranty period. Kmart will bear the reasonable expense of claiming the warranty. This warranty will no longer apply where the defect is a result of alteration, accident, misuse, abuse or neglect.

Please retain your receipt as proof of purchase and contact our Customer Service Centre on 1800 124 125 (Australia) or 0800 945 995 (New Zealand) or alternatively, via Customer Help at Kmart.com.au for any difficulties with your product. Warranty claims and claims for expense incurred in returning this product can be addressed to our Customer Service Centre at 690 Springvale Rd, Mulgrave Vic 3170.

Our goods come with guarantees that cannot be excluded under the Australian Consumer Law. You are entitled to a replacement or refund for a major failure and compensation for any other reasonably foreseeable loss or damage. You are also entitled to have the goods repaired or replaced if the goods fail to be of acceptable quality and the failure does not amount to a major failure.

For New Zealand customers, this warranty is in addition to statutory rights observed under New Zealand legislation.