

anko

43158775 Anko 10 person cabin tent



Please keep this instruction manual for future reference

IMPORTANT

**Please read instructions carefully. Familiarise yourself with the product before use.
Keep these instruction for future reference.**

Table of Contents

- Warnings
- Parts List
- Assembly Instructions
- Disassembly Instructions
- Care and Maintenance

Welcome



Congratulations on choosing to buy a Anko product.

All products brought to you by Anko are manufactured to the highest standards of performance and safety and as part of our philosophy of customer service and satisfaction, are backed by our comprehensive 1 year warranty.



We hope that you will enjoy using your purchase for many years to come.

Warnings









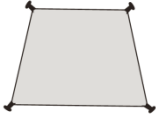

IMPORTANT SAFETY AND TIP INFORMATION

TO MAXIMIZE THE ENJOYMENT OF YOUR PRODUCT PLEASE ASSEMBLE AND USE YOUR PRODUCT AS SAFELY AS POSSIBLE. THE PURPOSE OF THE SAFETY ALERT SYMBOL  IS TO CALL YOUR ATTENTION TO POSSIBLE HAZARDS RELATING TO THE USE AND ASSEMBLY OF YOUR PRODUCT. THE PURPOSE OF THE TIP SYMBOL  IS TO CALL YOUR ATTENTION TO SUGGESTIONS THAT WILL ASSIST YOU IN THE ASSEMBLY/DISASSEMBLY PROCESS AND ENHANCE YOUR CAMPING EXPERIENCE. WHEN YOU SEE THESE SYMBOLS, PLEASE CLOSELY FOLLOW THE INFORMATION PROVIDED.

WARNING

- **KEEP ALL FLAME AND HEAT SOURCES AWAY FROM THIS TENT FABRIC.** This fabric is not fireproof! The fabric may burn if left in continuous contact with any flame source.
- Do not erect this product near an open flame.
- Never use any fuel burning, oxygen consuming devices, or any device that produces fumes (including, but not limited to cooking stoves, lanterns, candles, hibachis, or heaters) in or around your product. Inhalation of fumes may result in carbon monoxide poisoning, injury and/or death.
- Your product is water repellent, however, during heavy rain some leakage may occur. Keep objects from touching the inside, as objects may cause leakage at the point of contact.
- To prevent seam leakage (floor seams in particular), a seam sealer compound must be applied to the seams. Use recommended water repellent compounds on our product. Read the label on any product before using. Questions? Call our Customer Service number.
- Your recreational product is made from synthetic fabric that has been treated and is highly resistant to the sun's Ultraviolet (UV) light. No fabric can withstand prolonged exposure to sunlight. UV damage is not covered by the limited warranty.
- Do not spray or apply insecticide or pesticide on your product. It may damage UV resistant and/or water repellent properties of our product. Any damage caused by applying insecticide or pesticide on your product is not covered by the limited warranty.
- Our recreational products are constructed to rigid specifications. They are not made, however, for extreme weather, climates, or environments. Modification, abuse and extreme weather are some conditions that may adversely affect the structural integrity.
- Additional precautions may be necessary during inclement or "surprise" weather conditions. Here are some tips that may help during these times.
 -  Use guy lines to help secure your structure during periods of heavy winds.
 -  Storms or steady rains may collect in water pockets on the roof. This will add weight, which can weaken the overall structure causing the uprights to collapse. Maintain a watchful eye and remove any water accumulation that may occur.

Parts List

No.	Part Name	Image	Quantity
1	Inner tent body		1
2	Flysheet body		1
3	Divider curtain		1
4	Fiberglass pole A		2
5	Fiberglass pole B in grey color coded		1
6	Steel pole C		4
7	Steel pole D in grey color coded		2
8	Steel pole E		3
9	Guy ropes		9
10	Pegs		25

Assembly Instructions

Verify Parts

Refer to the parts list and verify all the parts are included and undamaged.

Assemble poles

Take out the fiberglass poles from bag. Assemble the poles by each section joined together with ferrule.



Ax2 

Bx1 

Cx4 

Dx2 

Assemble inner tent

On a level surface, unfold the tent so all the corners are visible. Insert all poles through the corresponding color coded poles sleeve on tent inner. Fix the C poles into the 2 way hub in center. Set up the tent with pic insert into the pole end ferrel.

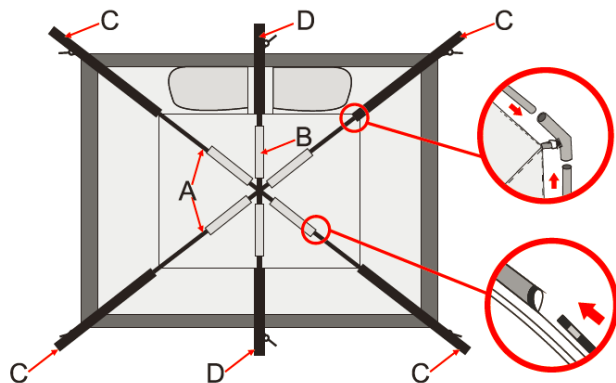

Secure the inner tent with peg through the ring on the pin&ring into the ground.



Cover the flysheet on the inner tent, fix with buckle and pegs through the elastic cord ring at the bottom of corners.



Assembly Instructions

Release the guy ropes pre-attached on flysheet, secure the guy ropes to make tent stay more stable. Front door can be set up by steel poles to create awning.

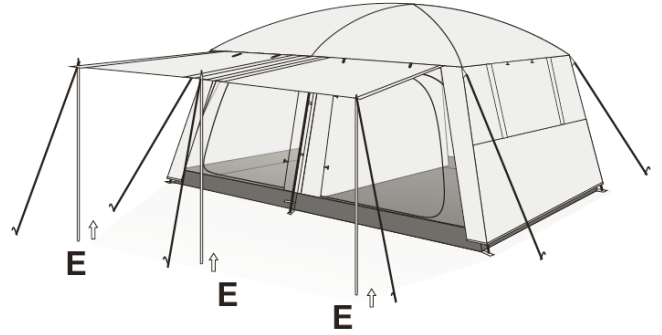

Disassembly Instructions

Release the buckle on floor corner and take of the flysheet from inner tent.



Retreat the steel pole from pin&ring and hubs.



Draw out the fiberglass pole from pole sleeve. Then pack back all poles and tent body into bags.

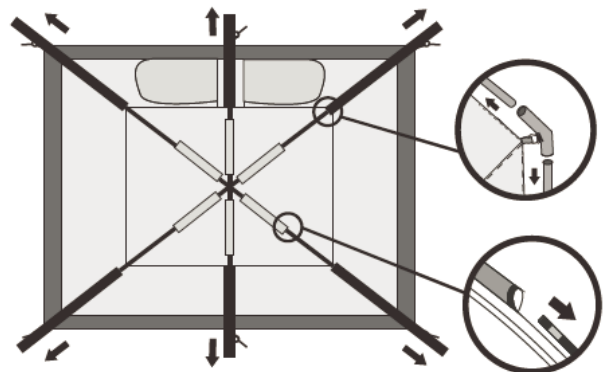

TROUBLESHOOTING GUIDE

Problem	Solution
1. Condensation	This is caused by lower temperatures on the outside of the tent combined with body heat on the inside of the tent. When this occurs, avoid touching walls to reduce contact leakage. Leaving the doors and windows open will reduce moisture condensation.
2. Mildew	To avoid mildew never put your tent away wet or damp. However if mildew occurs use a soft cloth or sponge with mild soap to clean. Let the tent dry in the sunlight.
3. Repairing A Tear	For small tears please use a self-adhesive patch kit. For larger tears, a canvas or awning repair shop may be able to assist.
4. Separated Zippers	All of our tents come with self-repairing nylon coil zippers. If the zipper separates, you can move the slider to the beginning of the zipper tape and rework the zipper.
5. Broken Pole	If a tent pole breaks due to excessive loading then please call 0800 422 274 for a replacement. Before calling please note the tent name stated in top left corner and which of the poles is broken. The poles are colour coded at each end to help this process.
6. Floor Condensation	An extra ground sheet under the tent prevents the floor from feeling damp and helps prolong the life of the tent floor. The sheet should be approx 6" shorter than the tent floor to prevent rain from running under the tent.
7. Removing Stakes	Stakes should be removed from the ground by using another stake, hammer, or a stake puller, never by pulling on the tent . Avoid staking tent so tight that it stretches the fabric. Overstretching may cause stake loops to wear.
8. Seam Leaking	The seams on your tent have been heat tape sealed. However, should you experience leakage at a seam, apply a seam sealer to the affected area.

PLEASE NOTE:

BEFORE RETURNING THIS UNIT TO THE STORE, PLEASE CONTACT THE NUMBER ABOVE FOR REPLACEMENT PARTS.

Care and Maintenance

- Your product must be stored dry. One of the easiest ways to damage your product is storing it while it is wet. Storing a wet tent as short a 24hours in warm weather is likely to cause mildew on the fabric coatings and are not covered by the limited warranty.
- If you must close camp in the rain, open your product and set it up to allow it to dry as soon as possible. Even when your product appears to be dry after use, it is always best to unfold and assure it is completely dry before storing. Hanging it outside or even leaving loosely clumped in your house for a few days. Turning it inside and out to assure it had dried everywhere, can help prevent damage.
- Do not leave your product set up for weeks at a time. Exposure to ultraviolet rays from the sun can damage and/or discolor the material.
- Clean the product, when it is set up, using a mild soap and lukewarm water solution. Rinse and dry completely. Do not use detergent, washing machines, or dryers because they can damage the tent/shelter's protective coating and seams.
- Clean the poles with a cloth and lubricate them with a silicone spray to help prevent corrosion and keep from being gritty. This is especially important after using the product around the salt water.
- Store the stakes in a separate storage bag. Do not pack the stakes inside the product body.

(Made In China)