

anko ROLLER BLIND Installation Instructions

Description							
Quantity /item	Ball Chain	End Cap	Bracket	Screws	Plugs	Cord Tension Device	Chain Joiner
ALL SIZE	1	1	2	5	5	1	1

Installation Options:

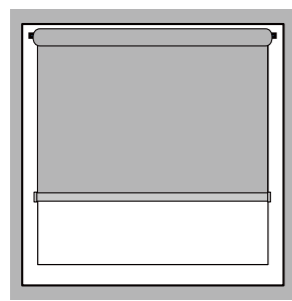

Recess Mount: Inside Frame

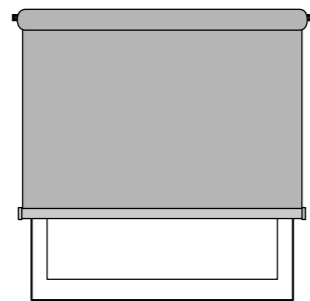

Outside Mount: Outside Frame

Determine whether you prefer the fabric to roll 'forwards' or 'backwards'. Check your window space for winders and sills that may obstruct the operation of the roller blind. This may alter your preference.

FORWARD ROLL



BACKWARD ROLL

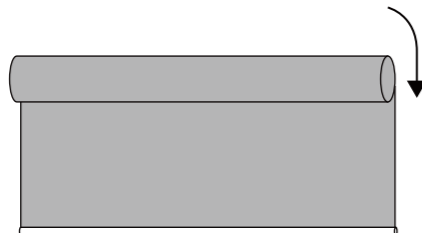

anko ROLLER BLIND Installation Instructions

- 1** Insert the ball chain system and end plug into the openings of the roller tube.
- Note: The ball chain system and end plug may be inserted on either end of the roller tube depending on the mounting side that best suits your window.

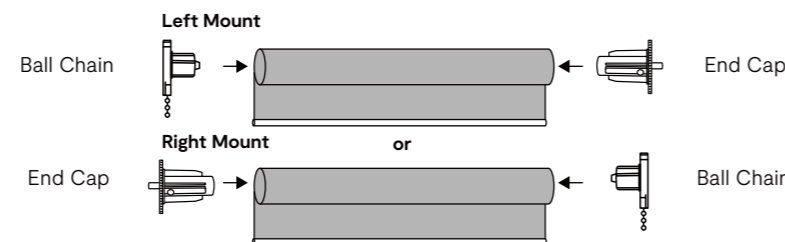

- 2** Note: Brackets are universal and can be 'top' mounted or 'face' mounted to the side of your window.

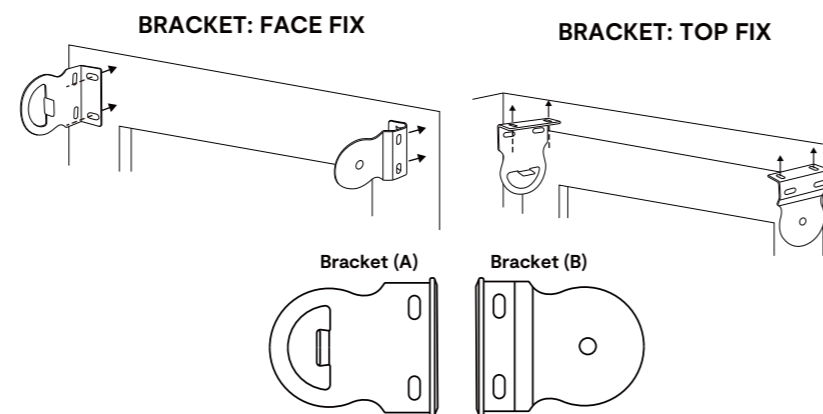

- On the window frame, determine the locations for the brackets and mark with a pencil. **IMPORTANT:** Ensure bracket markings are level before proceeding.
- Two brackets are provided. Bracket (A) is used for the ball chain system. Bracket (B) is used for the end plug.
- Mount bracket (A) on one side of the window frame chosen for the ball chain system. Drill pilot holes and then secure with screws (provided). Note: use the masonry plugs if drilling into brick or concrete walls.
- Mount bracket (B) on the opposite side of the window frame using the same process as bracket (A).

anko ROLLER BLIND Installation Instructions

- 3** Hanging your blind:
- Attach the end of the ball chain system on to bracket (A)
 - Insert the end of the plug side into bracket (B)

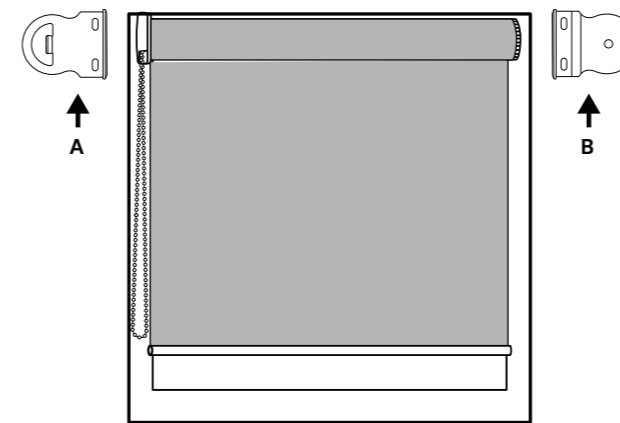

- 4** **IMPORTANT:** Installation of Child Safety Device
- WARNING: A chain/cord tension device is required to be fixed to a wall or window frame to reduce the chance of strangulation of young children.**
- Position the cord tension device on the solid timber/aluminium window frame or stud behind plaster board wall, that allows the ball chain to move easily through the tension device. Ensure the ball chain is entirely lowered, stretched and tangle free and operates smoothly.
 - Mark the hole with a pencil. Pre drill hole with a smaller drill bit, then secure the tension device with the screws provided (as seen in diagram below). Note: use the masonry plugs if drilling into brick or concrete walls.

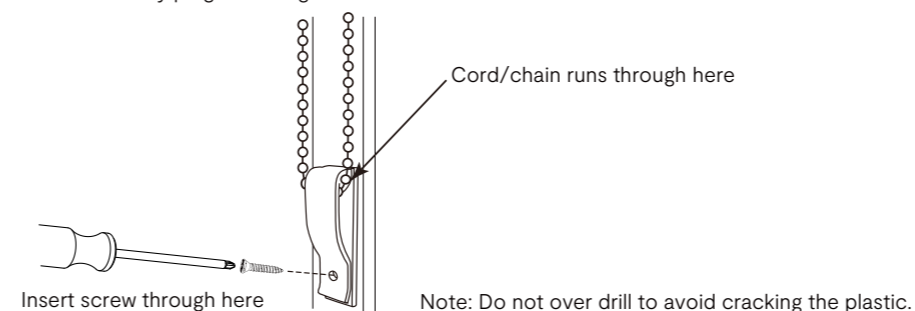

anko ROLLER BLIND Installation Instructions

- 5** Blind: Ready for use

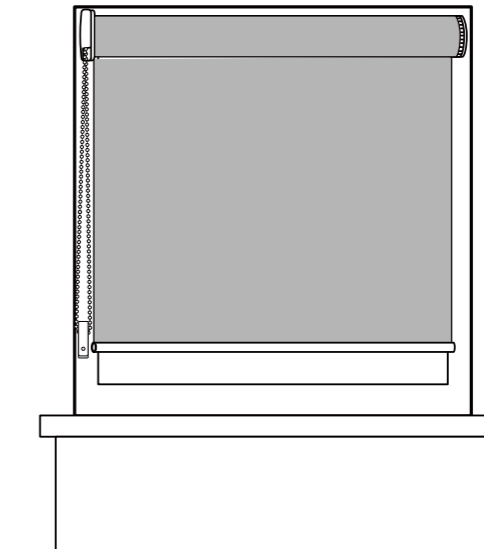

CARE INSTRUCTIONS:
DO NOT ALLOW DUST TO ACCUMULATE.
LIGHTLY DUST OR WIPE CLEAN.
DO NOT BLEACH.
SPOT CLEAN WITH WARM WATER IF NEEDED.
DO NOT DRY CLEAN.

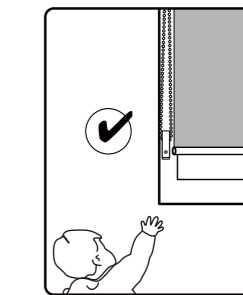

WARNING: To avoid creating a possible strangulation hazard for children, the corded internal window covering must be installed in such a way that a loose cord cannot form a loop 220mm or longer, at a height of less than 1600mm above floor level.

SUGGESTIONS FOR INSTALLING CORDED INTERNAL WINDOW COVERINGS:

- A cord guide may be installed lower than 1600mm above floor level if the *cord is sufficiently secured or tensioned to prevent a loop 220mm or longer from being formed; and
- If a cord guide is installed lower than 1600mm above floor level it must be designed to prevent a child from being able to remove the cord; and
- If a *cleat is used to secure the cord it must be at least 1600mm above floor level because a child is capable of unwinding a cord from a cleat.

*cord: rope, strap, string, chain, line or wire used to manipulate a corded internal window covering.
*cleat: a device having a bar with arms around which a cord can be wound and that can be attached to a wall or other structure.

WARNING **WARNING: CURTAIN AND BLIND CORDS HAVE CAUSED THE DEATH OF YOUNG CHILDREN AND MUST BE INSTALLED SO THAT THEY ARE NOT A STRANGULATION HAZARD. FOLLOW THE INSTALLATION INSTRUCTIONS.**