

Assembly Instructions

43164455 SCANDI CHEST OF DRAWERS

CARE INSTRUCTIONS:















WIPE CLEAN WITH A SOFT DAMP CLOTH. NEVER USE SCOURERS, ABRASIVES OR CHEMICAL SOLVENTS. KEEP AWAY FROM MOISTURE AND DIRECT SUNLIGHT. STORE IN A DRY PLACE. FOR INDOOR USE ONLY.

WARNING:







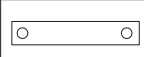









DO NOT STAND, SIT OR LEAN ON THE UNIT. DO NOT USE THIS UNIT AS A STEP LADDER. ENSURE THIS UNIT IS USED ONLY ON A FLAT SURFACE. DO NOT USE THIS UNIT UNLESS ALL BOLTS AND SCREWS ARE FIRMLY SECURED. DO NOT PLACE HOT OBJECTS SUCH AS COFFEE CUPS DIRECTLY ON THE SURFACE OF THIS FURNITURE ITEM. THIS ITEM IS FOR STORAGE PURPOSES ONLY. CONTAINS SMALL PARTS. IT IS TO BE ASSEMBLED BY AN ADULT. FAILURE TO FOLLOW THESE WARNINGS COULD RESULT IN SERIOUS INJURY.

MAXIMUM SAFE LOAD: 20KG FOR TOP, 10KG FOR EACH DRAWER.

1 Hardware List

	A	M6x35mm	23pcs		B	Ø15x10mm	23pcs		C	Ø6x30mm	8pcs
	D	M3.5x12mm	42pcs		E	M4x35mm	21pcs		F	M6x35mm	8pcs
	G	Ø5x48mm	4pcs		H		3pcs		I	Ø2x16mm	20pcs
	J	M4x12mm	8pcs		K	M4x24mm	4pcs		L	M3mm	1pc
	M	M4mm	1pc		N	Ø6x30mm	2pcs		O		2pcs

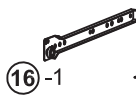
2 Parts List

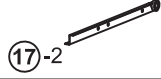
	1pc		1pc		1pc		1pc
	2pcs		1pc		3pcs		3pcs
	3pcs		3pcs		3pcs		3pcs
	2pcs		2pcs		2pcs	 	3pcs
 	3pcs						

3

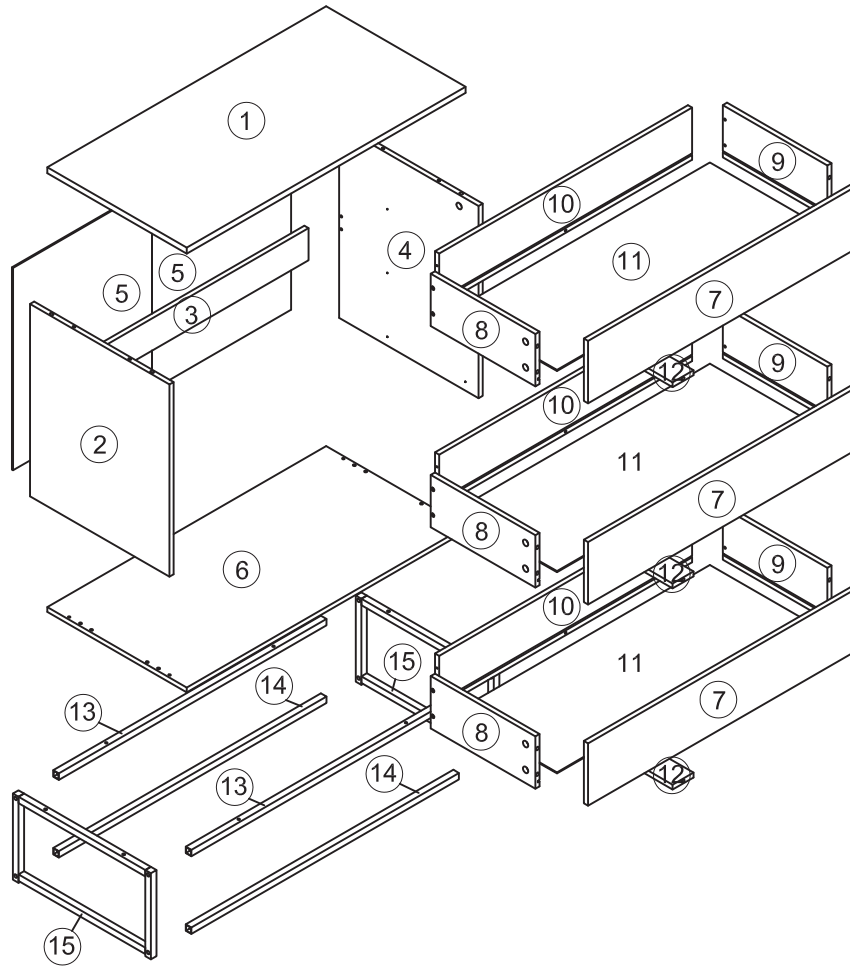

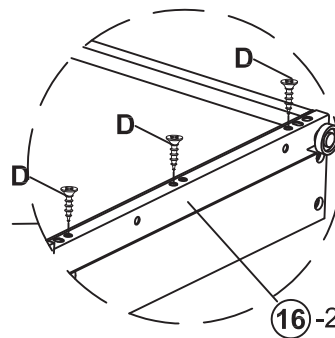
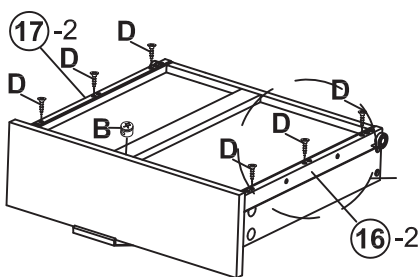
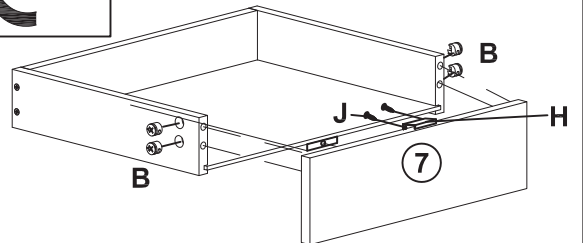
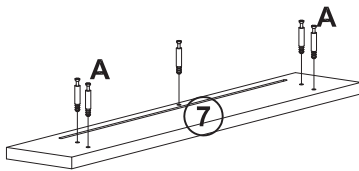
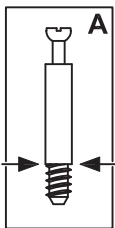
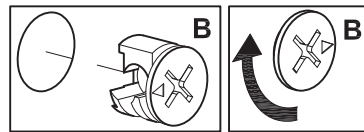
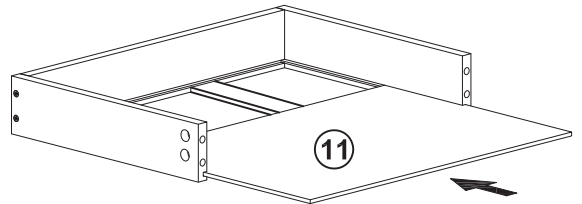
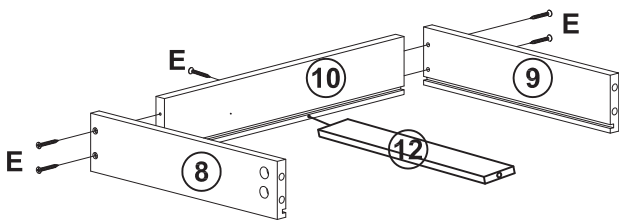

STEP 1 A - x 15 B - x 15 D - x 18 E - x 15 H - x 3 J - x 6





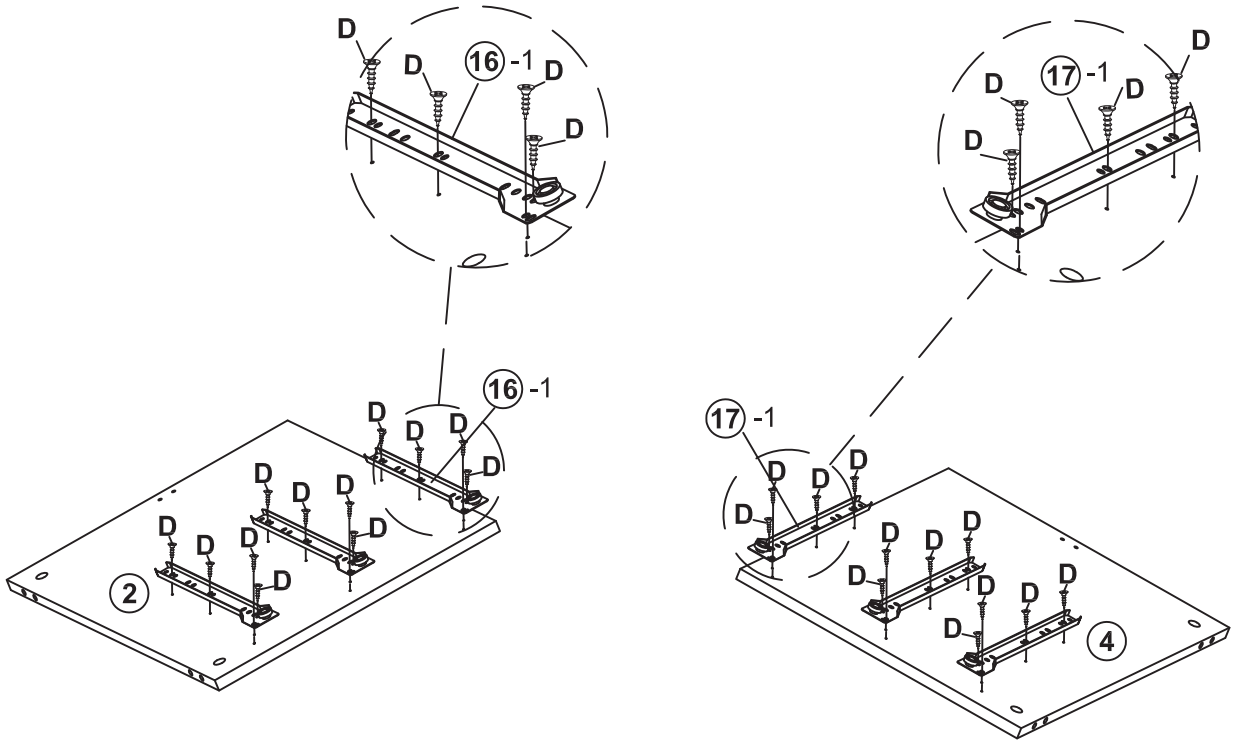

× 3

STEP 2 **D -  x 24**

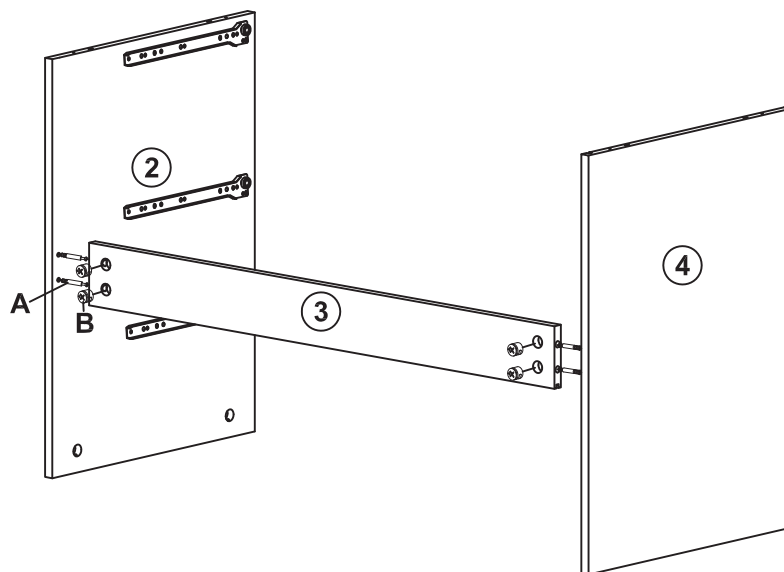



STEP 3 **A -  x 4** **B -  x 4**

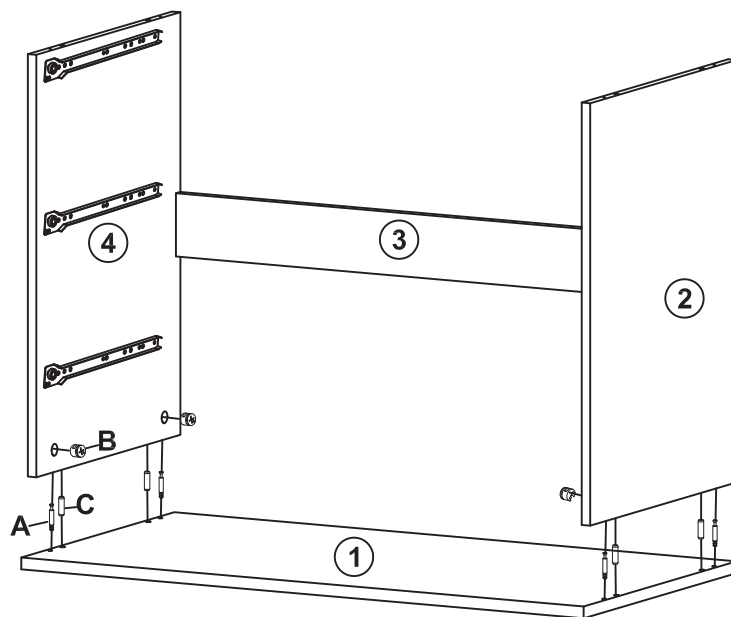

STEP 4 A -  x 4 B -  x 4 C -  x 4



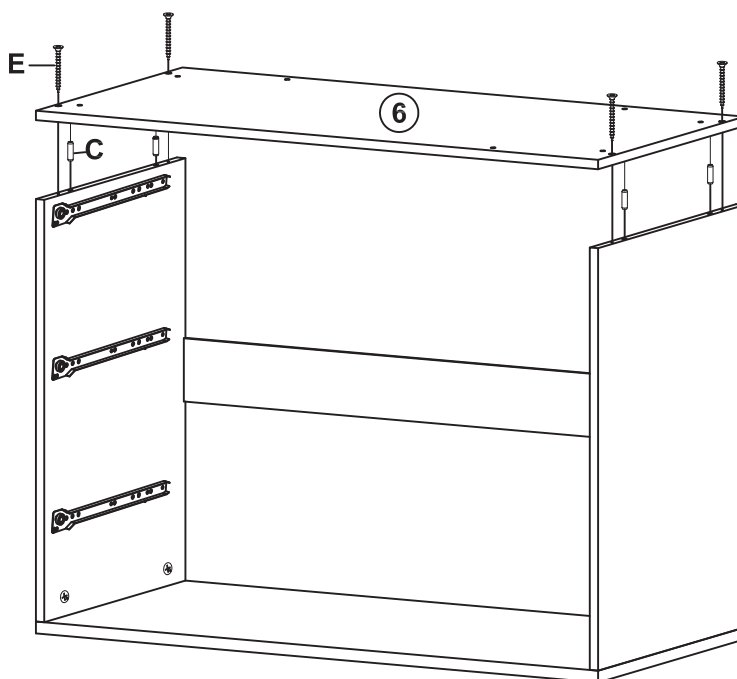

STEP 5 C -  x 4 E -  x 4

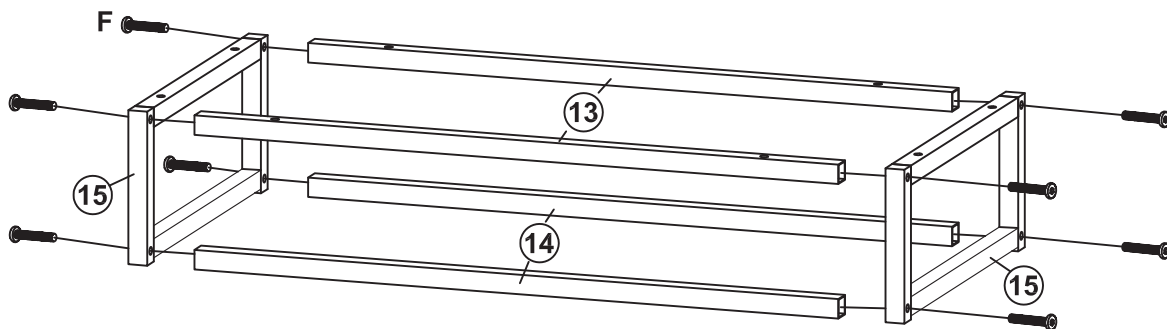

STEP 6 F -  x 8 M -  x 1



STEP 7 G -  x 4 K -  x 4 L -  x 1

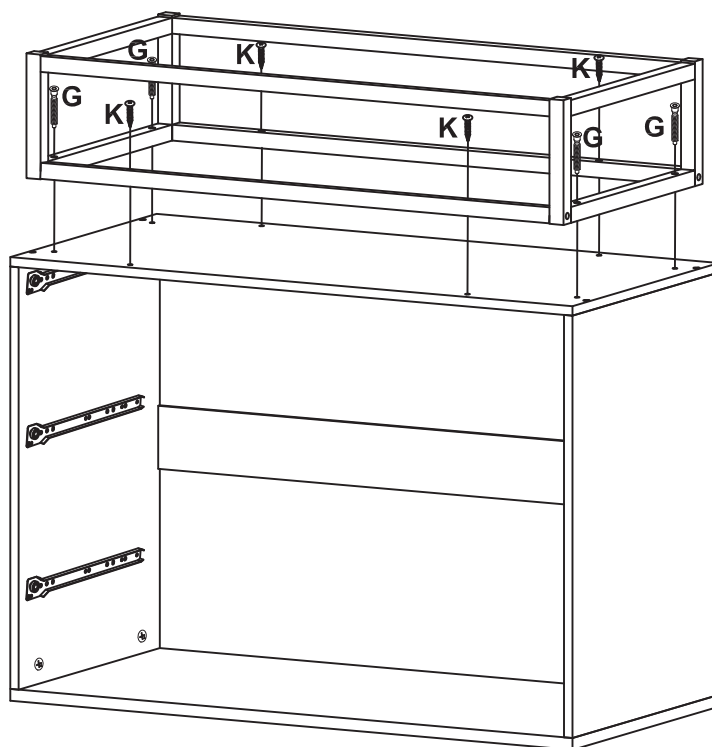

STEP 8

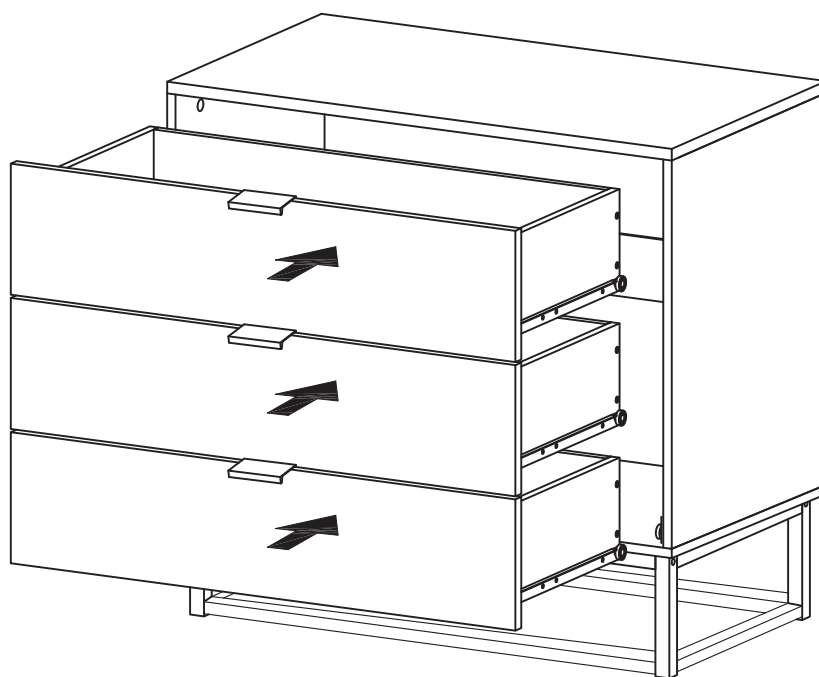

STEP 9 1-  x 20

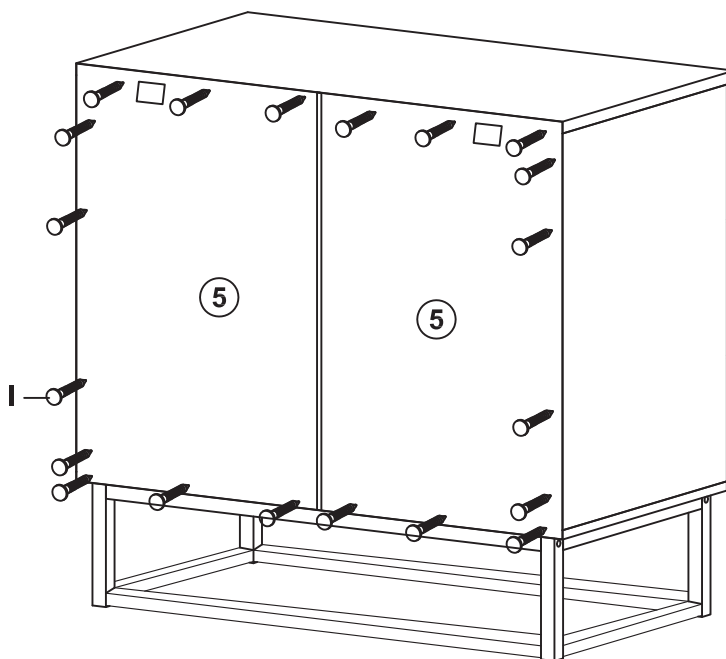
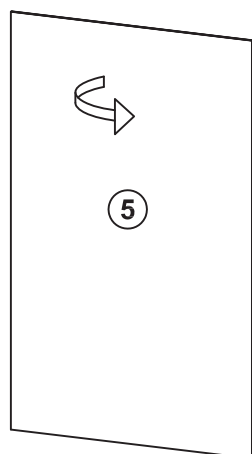

STEP 10 E -  x 2 J -  x 2 N -  x 2 O -  x 2

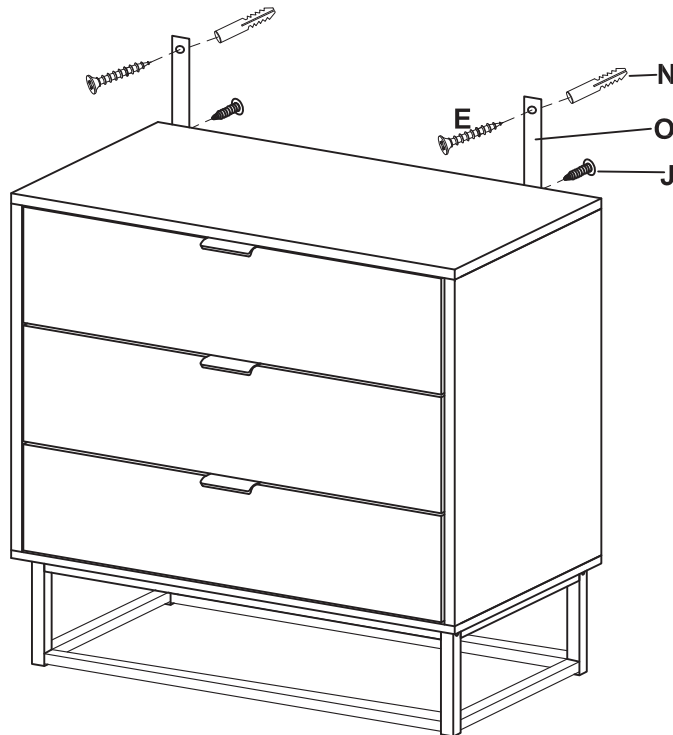

TOPPLING FURNITURE WARNING:

- **It is strongly recommended that this product is permanently fixed to the wall.**
- **Please seek professional advice if you are in doubt of what fixing device to use.**
- **Regularly check that anchors are securely maintained.**
- **Stability of tall items may be affected by thick pile carpet or uneven floors .**
- **Do not place unanchored televisions on furniture .**

CAUTION: for your safety when attaching the anchor fixings, please note the following:

- **Check any electrical wires or plumbing inside the wall before drilling any holes (if you are unsure please seek professional advice from a qualified tradesperson).**



WARNING: PLEASE SECURE YOUR FURNITURE WITH THE SUPPLIED WALL FIXING. SCAN THE CODE FOR MORE INFORMATION.

