

43165544

**RAFT BOAT SET**

**OWNER'S MANUAL**

**IMPORTANT SAFETY INSTRUCTIONS**

**WARNING**

Follow all the Safety and Operating Instructions. If you don't follow these instructions, it may cause overturn, explode the boat and causes to drowning.

- Before every use, carefully inspect all boat components including air-chambers, grab ropes, oars, and air valves, to ensure everything is in good condition and tightly secured. Please stop to repair if you find any damage.
- Passenger numbers and load weights shall by no means exceed specified capacities. Refer to the Technical Specifications section of this manual to determine passenger numbers and load weights for your boat. Overweight will cause overturn and drowning.
- Inflate according the numbered air chamber and rated pressure on the boat, or it will cause overinflation and boat explosion. Exceeding the data given on the capacity plate may cause the craft to damage, overturn and lead to drowning.
- Keep the boat balanced. Uneven distribution of persons or load in the boat may cause overturn the boat and drowning.
- **BE AWARE OF OFFSHORE WINDS AND CURRENTS.**
- Don't leave the boat exposed to sun for long periods of time, as high temperatures can increase air expansion, which can cause irreparable damage.
- Never transport the boat in inflated condition on the car. Be aware of the potential harmful effects of liquids such as battery acid, oil, petrol. The liquids may damage your boat.

**TECHNICAL SAFETY INSTRUCTIONS**

- Do not exceed the maximum recommended number of people. Regardless of the number of people on board, the total weight of people and equipment must never exceed the maximum recommended load. Always use the seats/seating spaces provided.
- When loading the craft, never exceed the maximum recommended load: Always load the craft carefully and distribute loads appropriately to maintain design trim (approximately level). Avoid placing heavy weights high up.
- The maximum recommended load includes the weight of all people on board, all provisions and personal effects, any equipment not included in the light craft mass, cargo (if any) and all consumable liquids (water, fuel, etc.).
- When using the boat, life saving devices such as life jackets and buoys should be pre-inspected and used at all times.
- Buckets, water scoops and air pumps should always be available in case of air leakage or if the boat takes on water.
- When the boat is in motion, all passengers must remain seated at all times to avoid falling overboard.
- Use the boat in protected shore-zones, up to 300m (984 feet). Be careful with natural factors such as wind, tides and tidal waves.
- Be careful when landing on the shore. Sharp and rough objects such as rocks, cement, shells, glass, etc. may puncture the boat.
- If one chamber is punctured when the boat is in the water, it may be necessary to fully inflate the other air chamber to prevent the boat from sinking.
- To avoid damage do not drag the boat on rough surfaces.
- Always wear a lifejacket!
- It is the responsibility of the owner/operator to have at least on bucket/bailer on board, secured against accidental loss.
- Be responsible, do not neglect the safety rules, this could jeopardize your life and the lives of others.
- Follow these instructions to avoid drowning, paralysis or other serious injuries.
- Know how to operate a boat. Check in your local area for information and/or training as needed. Inform yourself about local regulations and dangers related to boating and/or other water activities.
- Drawings for illustration purpose only. May not reflect actual product. Not to scale.

SAVE THESE INSTRUCTIONS

**TECHNICAL SPECIFICATIONS**

Item	Inflated Size	Maximum Weight	Passenger Capacity	Inflation Pressure
13516	1.88m x 98cm ( 6'2" x 39")	120 kg (264 lbs)	1 adult +1 child	0.03bar (0.5psi)

**INFLATE & ASSEMBLE**

**NEVER USE HIGH PRESSURE AIR TO INFLATE INFLATABLES. THIS CAN DAMAGE YOUR PRODUCT.**

- Inflate only as far that after inflating one can see some folding at the welding seams. After inflation compare the height of the printed scale on the product with the following table to make sure the height of each chamber is reached. Inflate bottom chamber and other accessories such as seat cushion until it is stiff to the touch but NOT hard. **DO NOT OVER INFLATE.**
- Take care that the boat has gotten to the correct pressure. Pay attention to both pressure scales on the type-plate and check the pressure from time to time, because in the sun the pressure can grow and it must be balanced then to the correct one.
- Extended exposure to sun can shorten the lifespan of your boat. We suggest to not leave boats in direct sunlight for more than 1 hour after use.
- When the oars(if included) are not in use, lock the oars into the oar clasps to avoid damage.
- Never stand on or rest objects on the boat during inflation.

Item	Product Inflated Size	Printed Scale			
		Deflated Size	Inflated Size Chamber 1	Inflated Size Chamber 2	Inflated Size Chamber 3
13516	1.88m x 98cm ( 6'2" x 39")	5cm / 10cm	5.1cm	5.4cm	11.3cm

**SAFETY ROPE**

- Please carefully check whether safety rope is in perfect condition and fastened tightly prior to each use.

**STORAGE**

- Remove the oars(if included) from the oarlocks. Keep all accessories for future use.
- Carefully clean the boat using a mild soap with clean water. Do not use acetone, acid, and/or alkaline solutions.
- Use a cloth to gently dry all surfaces. The product can be dry under direct sunlight for no more than 1 hour, extended exposure to sun can shorten the lifespan of the boat.
- Deflate the hull chambers. Deflate all the hull chambers at the same time so the air-pressure drops simultaneously.
- This will prevent damage from occurring to the boat's inner structures. Next, deflate the floor.
- Fold the boat from front to back to remove additional air. You can also use a pump to drain any remaining air.

**REPAIR**

- If there is a small puncture, repair it according to the instructions on the repair patch.
- If the hole is too big to be repaired with the provided patch, purchase a Bestway repair kit or send the boat to a specialty shop to make the repair.

**PLEASE KEEP THIS MANUAL IN A SECURE PLACE, AND HAND IT OVER TO THE NEW OWNER WHEN YOU SELL THE CRAFT.**

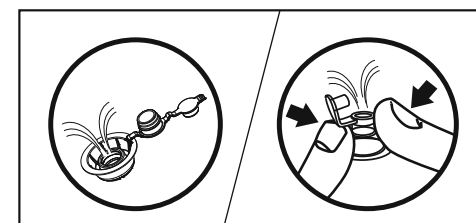
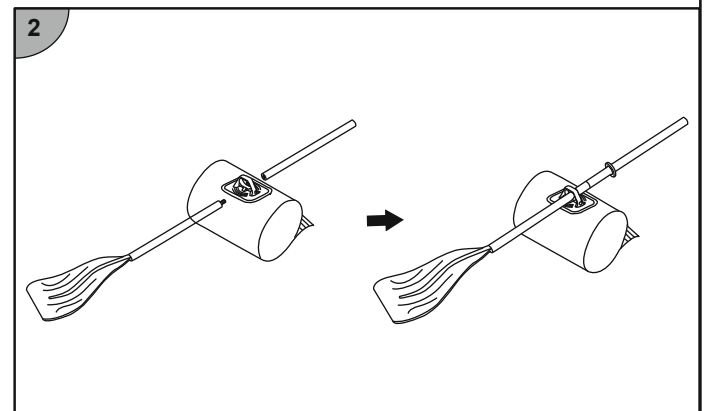
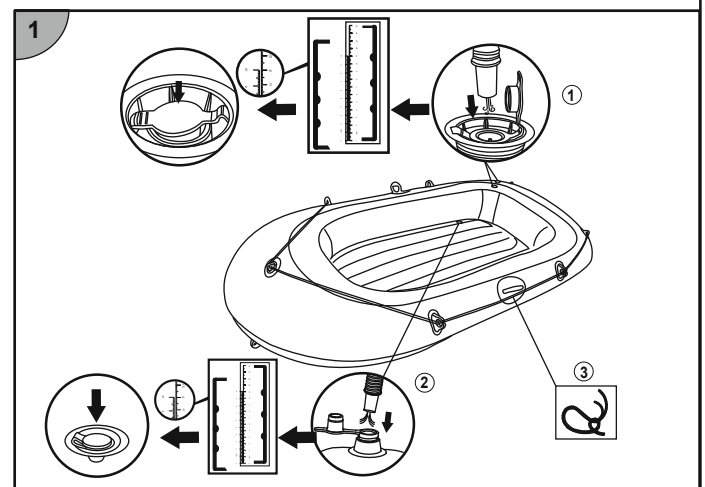
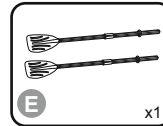
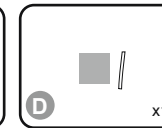
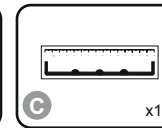
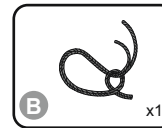
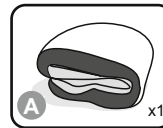



FOR AU / NZ: IMPORTED FOR KMART  
STORES IN AUSTRALIA AND NEW ZEALAND.

©2022 Bestway Inflatables & Material Corp.

All rights reserved/Tous droits réservés/Todos los derechos reservados/Alle Rechte vorbehalten/Tutti i diritti riservati

Trademarks used in some countries under license from/

Marques utilisées dans certains pays sous la licence de/

Marcas comerciales utilizadas en algunos países bajo la licencia de/

Die Warenzeichen werden in einigen Ländern verwendet unter Lizenz der/

Marchi utilizzati in alcuni paesi concessi in licenza a

**Bestway Inflatables & Material Corp., Shanghai, China**

Manufactured, distributed and represented in the European Union by/

Fabriqués, distribués et représentés dans l'Union Européenne par/Fabricado, distribuido y representado en la Unión Europea por/

Hergestellt, vertrieben und in der Europäischen Union vertreten von/Prodotto, distribuito e rappresentato nell'Unione Europea da

**Bestway Europe S.p.a., Via Resistenza, 5, 20098 San Giuliano Milanese (Milano), Italy**

Distributed in Latin America by/Distribué en Amérique latine par/Distribuido en Latinoamérica por/Distribuído na América Latina por

**Bestway Central & South America Ltda, Salar Ascotan 1282, Parque Enea, Pudahuel, Santiago, Chile**

Distributed in Australia & New Zealand by **Bestway Australia Pty Ltd, Unit 2/98-104 Carnarvon St Silverwater, NSW 2128, Australia**

Tel: Australia: (+61) 2 9037 1388; New Zealand: 0800 142 101

Distributed in United Kingdom by **Bestway Corp UK Ltd, 8 Wentworth Road, Heathfield Industrial Estate, Newton Abbot, Devon, TQ12 6TL**

Exported by/Exporté par/Exportado por/Exportiert von/Esportato da

**Bestway (Hong Kong) International Ltd./Bestway Enterprise Company Limited**

Suite 713, 7/Floor, East Wing, Tsim Sha Tsui Centre, 66 Mody Road, Kowloon, Hong Kong

**[www.bestwaycorp.com](http://www.bestwaycorp.com)**