

# Assembly Instructions

## 43191086 Decorative Wooden Planter with Trellis

**CARE INSTRUCTIONS:**



WIPE CLEAN WITH A SOFT DAMP CLOTH. DO NOT USE ABRASIVE MATERIALS AND SOLVENTS. CHECK AND TIGHTEN ALL PARTS REGULARLY. KEEP AWAY FROM DIRECT SUNLIGHT. FOR USE WITH POTS AND SAUCERS. FOR DOMESTIC USE ONLY.

**WARNING:**

DO NOT STAND, SIT OR LEAN ON THE PRODUCT. USE ONLY ON A FLAT SURFACE. DO NOT USE UNTIL ALL SCREWS, BOLTS AND KNOBS ARE FIRMLY SECURED. THIS PRODUCT CONTAINS SMALL PARTS AND SHARP POINTS, KEEP AWAY FROM CHILDREN AND BABIES. ADULT ASSEMBLY REQUIRED. FAILURE TO FOLLOW THESE WARNINGS COULD RESULT IN SERIOUS INJURY. ALTHOUGH THIS ITEM IS DESIGNED FOR OUTDOOR USE, OVER TIME THE WOOD SURFACE MAY DETERIORATE. TO PROLONG THE LIFE OF THIS ITEM, KEEP DRY AND PROTECT FROM WET WEATHER. PRODUCT HAS HOLES FOR WATER DRAINAGE. ENSURE SURFACE BELOW IS SUITABLE OR PLACE A MAT OR TRAY UNDERNEATH.

**MAXIMUM SAFE LOAD OF PLANTER: 30KG.**



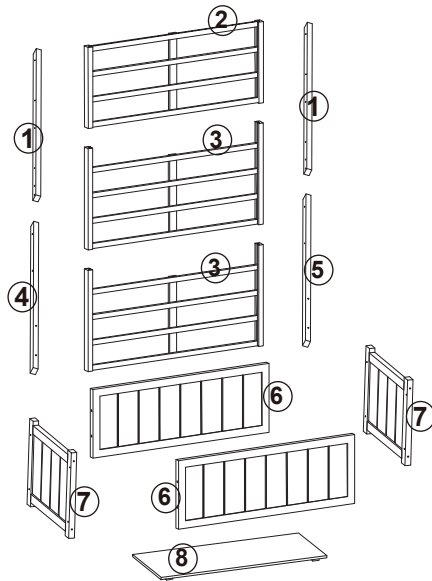

**Hardware list**

	a	M4X30mm	16PCS
	b	M4X40mm	12PCS
	c		8PCS

Assembly of this product requires the use of a Phillips head screwdriver (not included)

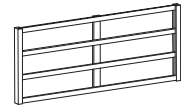
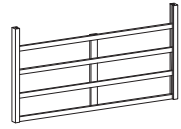

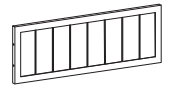
Do not tighten the screws fully during assembly.  
Fully tighten screws after the final assembly steps

					
①	2PCS	②	1PC	③	2PCS
					
④	1PC	⑤	1PC	⑥	2PCS
					
⑦	2PCS	⑧	1PC		

**STEP 1**  aX8

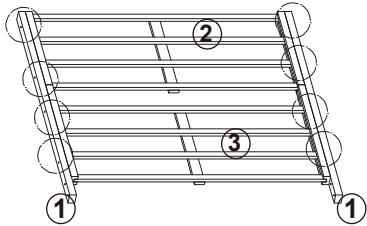
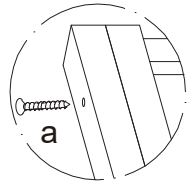

**STEP 2**  aX4

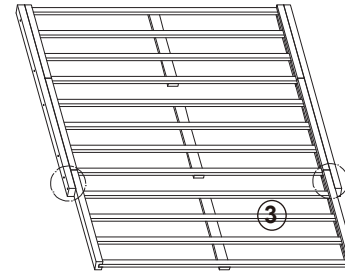
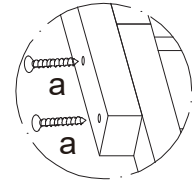

**STEP 3**  aX4

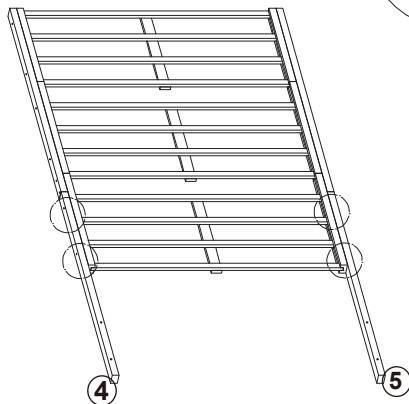
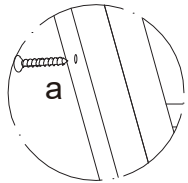

**STEP 4**  cX8

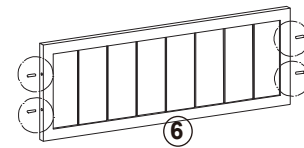
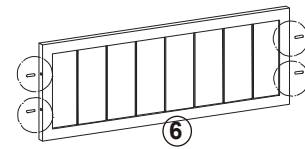
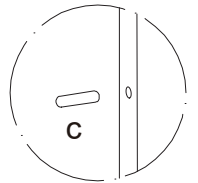

**STEP 5**  bX8

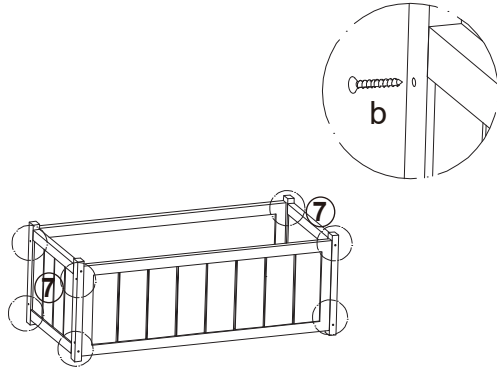

**STEP 6**

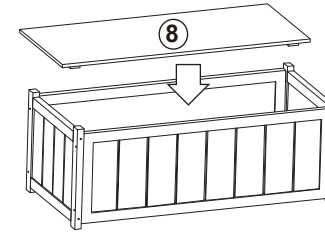

**STEP 7**  bX4

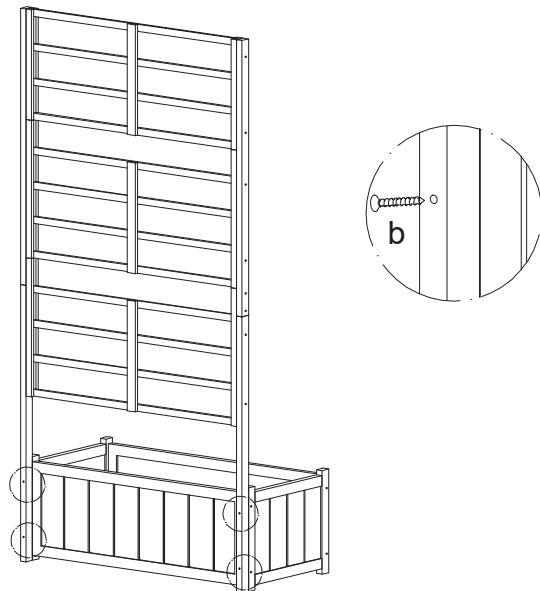

**STEP 8**

