

Bestway[®]

STEEL PRO[™]



bestwaycorp.com/support



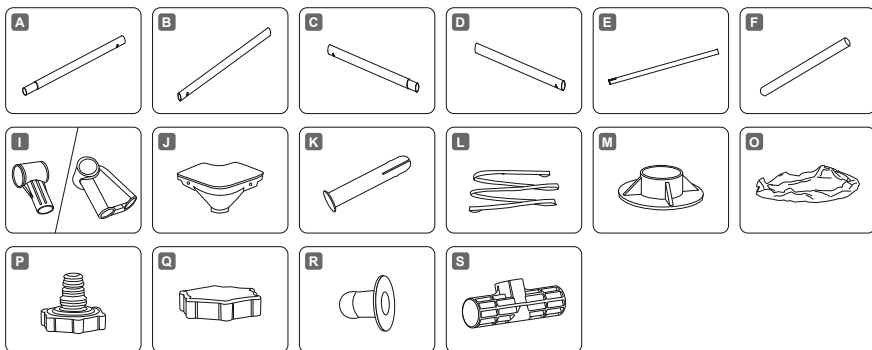

STEEL PRO™	2.21 m x 1.50 m x 43 cm (7'3" x 59" x 17")	2.59 m x 1.70 m x 61 cm (8'6" x 67" x 24")	3.00 m x 2.01 m x 66 cm (9'10" x 67" x 26")	4.00 m x 2.11 m x 81 cm (13'1" x 6'11" x 32")
	56545	56496	56498 56412	56512 56425
A	x0	x4	x4	x6
B	x2	x2	x2	x2
C	x6	x2	x2	x2
D	x2	x2	x2	x2
E	x0	x6	x6	x8
F	x8	x4	x10	x12
I	x4	x6	x6	x8
J	x4	x4	x4	x4
K	x8	x8	x8	x8
L	x0	x0	x1	x1
M	x8	x4	x10	x12
O	x1	x1	x1	x1
P	x1	x1	x1	x1
Q	x1	x1	x1	x1
R	x3	x3	x3	x3
S	x0	x6	x6	x8

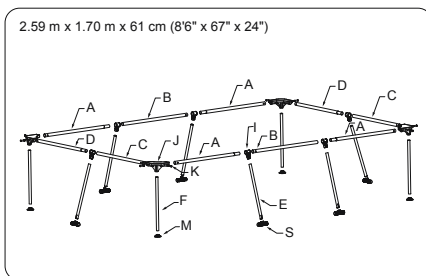
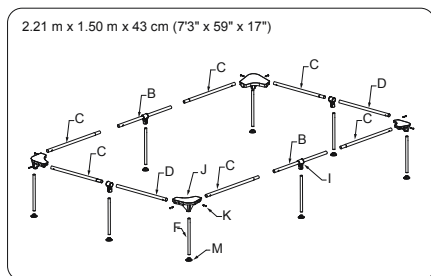

3.00 m x 2.01 m x 66 cm (9'10" x 6'7" x 26")

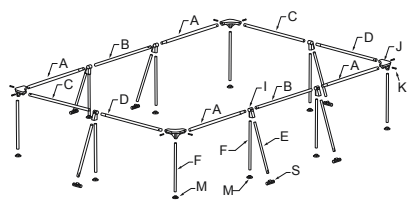

4.00 m x 2.11 m x 81 cm (13'1" x 6'11" x 32")

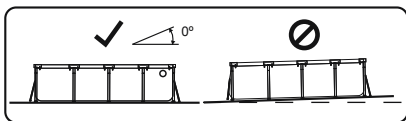
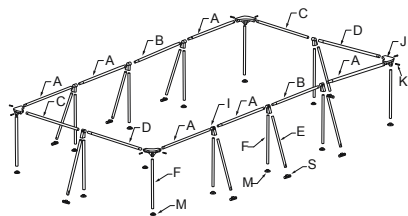

1

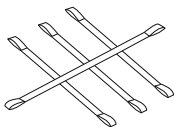

2

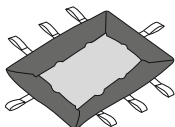

3

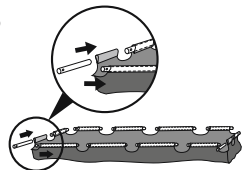

4

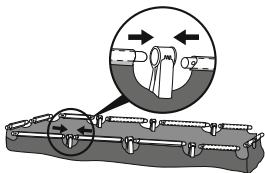

5

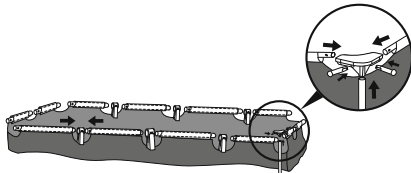

6

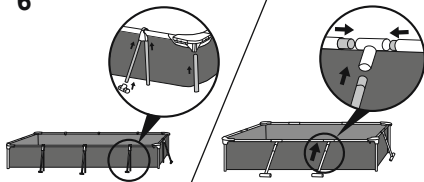

2.59 m x 1.70 m x 61 cm
(8'6" x 6'7" x 24")

7

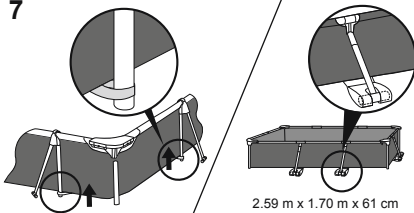

2.59 m x 1.70 m x 61 cm
(8'6" x 6'7" x 24")

8

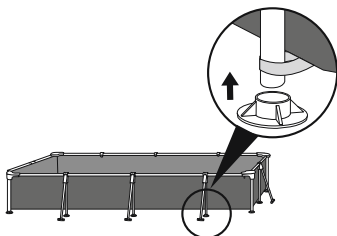

9

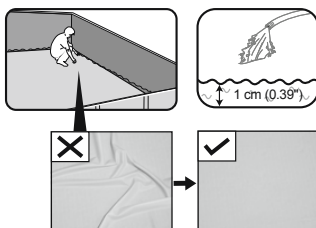

10

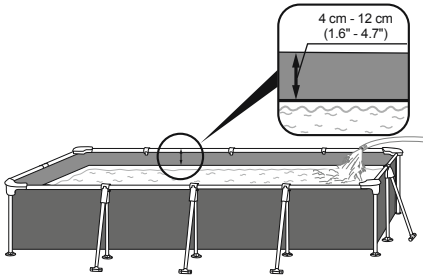

1

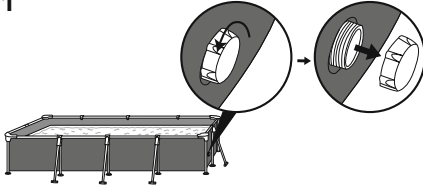

2

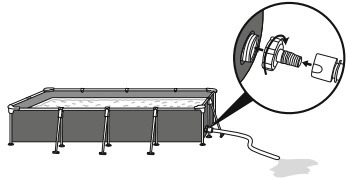

3

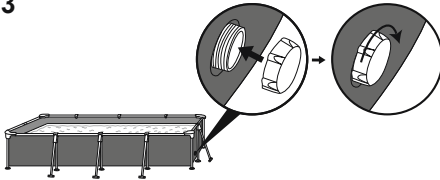



OWNER'S MANUAL



Visit the Bestway YouTube channel

IMPORTANT SAFETY INSTRUCTIONS

READ AND FOLLOW ALL INSTRUCTIONS.

- Carefully read, understand, and follow all information in this user manual before installing and using the swimming pool. These warnings, instructions, and safety guidelines address some common risks of water recreation, but they cannot cover all risks and dangers in all cases. Always use caution, common sense, and good judgment when enjoying any water activity. Retain this information for future use. In addition, the following information can be supplied depending on the pool type.
- Keep these instructions in a safe place. If instructions are missing, please contact the manufacturer or search it on the website www.bestwaycorp.com.
- Designate a competent adult to supervise the pool each time it is being used.
- Barriers, pool covers, pool alarms, or similar safety devices are helpful aids, but they are not substitutes for continuous and competent adult supervision.

Safe use of the pool

- Encourage all users especially children to learn how to swim.
- Learn Basic Life Support (Cardiopulmonary Resuscitation CPR) and refresh this knowledge regularly. This can make a life-saving difference in the event of an emergency.
- Instruct all pool users, including children, what to do in case of an emergency.
- Never dive into any shallow body of water. This can lead to serious injury or death.
- Do not use the swimming pool when using alcohol or medication that may impair your ability to safely use the pool.

Safety devices

- In order to prevent children from drowning, it is recommended to secure the access to the pool with a protection device. In order to prevent children climbing from the inlet and outlet valve, it is recommended to install a barrier (and secure all doors and windows, where applicable) to prevent unauthorized access to the swimming pool.

Safety equipment

- It is recommended to keep rescue equipment (e.g. a ring buoy) by the pool.
- Keep a working phone and a list of emergency phone numbers near the pool.
- When pool covers are used, remove them completely from the water surface before entering the pool.
- Protect pool occupants from water related illnesses, by keeping the pool water treated and practicing good hygiene. Consult the water treatment guidelines in the user's manual.
- Store chemicals (e.g. water treatment, cleaning or disinfection products) out of the reach of children.
- Use the signage as outlined below. Signage is to be displayed in a prominent position within 2m of the pool.



Keep children under supervision in the aquatic environment. No diving.

- Removable ladders shall be placed on a horizontal surface.
- Irrespective of materials used for swimming pool construction, accessible surfaces have to be checked regularly to avoid injuries.
- Regularly monitor bolts and screws. Remove splinters or any sharp edges to avoid injuries.
- Do not leave the drained pool outside. The empty pool is liable to become deformed and/or displaced due to wind.
- If you have a filter pump, refer to the pump's manual for instructions.
- The pump cannot be used while people are inside the pool!
- If you have a ladder, refer to the ladder's manual for instructions.
- **WARNING!** The use of a swimming pool implies compliance with the safety instructions described in the operating and maintenance guide. In order to prevent drowning or other serious injuries, pay particular attention to the possibility of unexpected access to the swimming pool by children under 5 years by securing the access to it, and, during the bathing period, keep them under constant adult supervision.

Non Swimmers safety

- Continuous, active, and vigilant supervision of weak swimmers and non-swimmers by a competent adult is required at all times (remembering that children under five are at the highest risk of drowning).
- Weak swimmers or non-swimmers should wear personal protection equipment when using the pool.
- When the pool is not in use, or unsupervised, remove all toys from the swimming pool and its surrounding to avoid attracting children to the pool.

PLEASE READ CAREFULLY AND KEEP FOR FUTURE REFERENCE.

PRE-SETUP

CHECK LIST

Check the parts inside the manual. Verify that the equipment components represent the model that you had intended to purchase. In case of any damaged or missing parts at the time of purchase, visit our website bestwaycorp.com/support.

CHOOSE THE CORRECT LOCATION

The surface chosen to install the pool on must respect the following conditions:

- Because of the combined weight of the water inside the pool and the pool users, it is extremely important that the surface chosen to install the pool on is capable of uniformly supporting the total weight for the entire time the pool is installed. When choosing the surface, take into consideration that water may come out of the pool when in use or when it rains. If the water softens the surface, it may lose its capability to support the pool weight.
- Check the position of the vertical legs and/or the U-supports regularly. They must be on the same level as the bottom of the pool at all times. If the vertical leg or the U-support starts to sink into the ground, drain the pool water immediately to avoid the pool collapsing due to the uneven loading on the frame structure. Change the location of the pool or modify the surface material.
- The surface must be flat and smooth. If the surface is inclined or uneven, it can create an unbalanced loading on the structure of the pool. This can damage the welding points of the liner and bend the frame. In the worst cases, the pool can collapse, causing serious personal injury and/or damage to personal property.
- We recommend positioning the pool away from any objects children could use to climb into the pool.
- Position the pool near an adequate drainage system to deal with overflow or to empty the pool. Ensure the pool side with the water inlet A and outlet B is located in the same direction of the power source, where the filtration system has to be connected.
- The selected surface must be clear of any type of object. Due to the weight of the water, any object under the pool could damage or perforate the bottom of the pool.
- The selected surface must be clear of aggressive plants and weed species. Those types of strong vegetation could grow through the liner and create water leakage. Grass or other vegetation that may cause odor or slime to develop have to be eliminated from the set-up location.
- The selected location must not have overhead power lines or trees. Be sure the location does not contain underground utility pipes, lines or cables of any kind.
- The selected position must be far from house entrance. Do not position any equipment or other furniture around the pool. The water that comes out of the pool during use or due to product faults can damage furniture inside the house or surrounding the pool.
- The selected surface must be flat and without holes that can damage the material of the liner.

Supported set-up surfaces: grass, ground, concrete, and all other surfaces that respect the above set-up conditions.

- Surfaces to avoid:** mud, sand, gravel, deck, balcony, driveway, platform, soft/loose soil or other surface that does not meet the above set-up conditions.
- Check with your local city council for by-laws relating to fencing, barriers, lighting and safety requirements and ensure you comply with all laws.
 - If a pump and/or ladder is included in the set, refer to the pump's and/or ladder's manual for safety instructions and installation. The ladder must match the pool size.
 - If during set up it is necessary to change the position of the pool, lift up the liner and do not drag it on the ground; the friction between the PVC material and the ground can damage the pool liner.
 - **Follow the important instructions above to choose the correct surface and location to set up your pool. Damaged parts of the pool, due to the fact that the set-up surface and location does not match the instructions, will not be considered as manufacture defect and will avoid the warranty and any service claims.**

INSTALLATION

ASSEMBLING

- For installation instructions, follow the drawings inside the manual. Drawings are for illustration purposes only. May not reflect actual product. Not to scale.
- Assembly of the Frame Pool can be completed without tools.
- Installation usually takes approximately 10-20 minutes with 2-3 people excluding filling.
- To lengthen the life of your pool, it is important to sprinkle the top rails with the Talcum Powder before assembly. Talcum Powder is not included in the package.
- Bestway will not be responsible for damage caused to the pool due to mishandling or failure to follow these instructions.
- We strongly suggest opening the package and assembling the pool when the environment temperature is above 15°C / 59°F; the PVC material of the liner will become more flexible and easier to assemble.

FILLING POOL WITH WATER

- Do not leave pool unattended while filling with water.
- Fill the pool with water after all assembly steps are completed and until the water reaches the welding line, which corresponds to 90% of the full capacity.
- Do not overfill as this could cause the pool to collapse. In case of heavy rainfall, we strongly recommend to reduce the water level to keep it at 90% capacity, to avoid overflowing of the water.
- When the pool is completely filled, check that the distance between the water surface and the top of the rails is the same all around; if it is different, it means that the floor is not leveled so we strongly recommend to drain the water and re-level the ground.
- Keeping the pool full of water on unlevelled ground can cause bursting of the welding points and/or pool collapse, causing serious personal injury and/or damage to property.

MAINTENANCE

If you do not adhere to the maintenance guidelines below, your health might be at risk, especially that of your children.

WATER

- Keeping your pool water clean and chemically balanced is necessary. Simply cleaning the filter cartridge is not enough for proper maintenance; we recommend you use pool chemicals to maintain water chemistry and chlorine or bromine tablets (do not use granules) with the chemical dispenser.

- Water quality is directly related to frequency of use, number of users and overall maintenance of the pool. The water should be changed every 3 days if there is no chemical treatment being performed with the water. It is highly recommended to use tap water for filling to minimize the influence of unwanted content, such as minerals.
- We recommend that you take a shower before using your pool, as cosmetic products, lotions, and other residues on the skin can quickly degrade water quality.
- Skim pool regularly to avoid settled dirt.
- Locate a bucket of water next to pool to clean users' feet before entering pool.
- The chemical maintenance must be performed with ChemConnect or chemical floater; don't throw chemical products directly in the water, the chemical will deposit on the bottom and damage the material and discolor the PVC.

Chemical Tablets (Not Included):

- Your purchased pool set may not include any dispensers; in this case you can purchase one by visiting our website www.bestwaycorp.com or at the nearest pool dealer.
- Remove the chemical dispenser from pool when the pool is in use.
- After performing chemical maintenance and before using the pool, use a test kit (not included) to test the water chemistry. We recommend maintaining your water chemical balance as shown in the below table.

TEST	IDEAL VALUES
pH value	7.4 – 7.6
Cyanuric acid	30 – 50 ppm
Free chlorine	2 – 4 ppm
Chlorine compound	0
Algae	None visible
Calcium hardness	200 – 400 ppm

- Pool damage resulting from misuse of chemicals and mismanagement of pool water is not covered by the warranty.
- Over usage of chemicals will discolor the printing and all points of the pool material; in worst cases, it will damage the structure of the pool liner.
- Pool chemicals are potentially toxic and should be handled with care. There are serious health risks from chemical vapors and the incorrect labeling and storage of chemical containers.
- Please consult your local pool or chemical supply retailer for more information about chemical maintenance. Pay close attention to the chemical manufacturer's instructions.
- The pump is used to circulate the water and to filter small particles. In order to keep your pool water clean and hygienic, you must also add chemicals.

LINER

- We suggested that you buy a pool cover, if not included in the set, and cover the pool when not in use, to prevent any damage to the Duraplus material on the top rails. Gently clean any dirt deposit on the top rails with a clean cloth.

DISASSEMBLY AND STORAGE

DRAINING

- For draining, follow the drawings inside the manual. Drawings are for illustration purposes only. May not reflect actual product. Not to scale.
- To drain your pool water, check local regulations for drainage by-laws.

CLEANING

- Rinse the pool liner with tap water, to remove any residual of chemicals or dirt completely.
- Leave the pool under the sunlight until it's completely dried.
- To remove the remaining water completely, wipe the pool liner with a dry cloth.

STORAGE

- Remove all accessories; be sure that pool liner and accessories are completely clean and dry before the storage. If the pool is not completely dry, mold may result and will damage the pool liner during the storage period.
- Once pool is completely dry, sprinkle with talcum powder to prevent pool from sticking together.
- We strongly recommend disassembling the pool when the environment temperature is below 10°C / 50°F.
- Fold the pool liner only if the environment temperature is above 10°C / 50°F. Store the pool in a dry place with a moderate temperature between 10°C / 50°F and 38°C / 100°F and position the pool liner and all accessories inside a carton box, to better protect the PVC material during the winter period.

REPAIR

In the event of a leak, patch your pool using the underwater adhesive repair patch provided. You can find the instructions in FAQs on the support section of our website, www.bestwaycorp.com/support.



For support please visit us at:
bestwaycorp.com/support

©2022 Bestway Inflatables & Material Corp.

All rights reserved/Tous droits réservés/Todos los derechos reservados/Alle Rechte vorbehalten/Tutti i diritti riservati

Trademarks used in some countries under license from/

Marques utilisées dans certains pays sous la licence de/

Marcas comerciales utilizadas en algunos países bajo la licencia de/

Die Warenzeichen werden in einigen Ländern verwendet unter Lizenz der/

Marchi utilizzati in alcuni paesi concessi in licenza a

Bestway Inflatables & Material Corp., Shanghai, China

Manufactured, distributed and represented in the European Union by/

Fabriqués, distribués et représentés dans l'Union Européenne par/Fabricado, distribuido y representado en la Unión Europea por/

Hergestellt, vertrieben und in der Europäischen Union vertreten von/Prodotto, distribuito e rappresentato nell'Unione Europea da

Bestway Europe S.p.a., Via Resistenza, 5, 20098 San Giuliano Milanese (Milano), Italy

Distributed in Latin America by/Distribué en Amérique latine par/Distribuido en Latinoamérica por/Distribuido na América Latina por

Bestway Central & South America Ltda, Salar Ascotan 1282, Parque Enea, Pudahuel, Santiago, Chile

Distributed in Australia & New Zealand by **Bestway Australia Pty Ltd, Unit 2/98-104 Carnarvon St Silverwater, NSW 2128, Australia**

Tel: Australia: (+61) 2 9037 1388; New Zealand: 0800 142 101

Distributed in United Kingdom by **Bestway Corp UK Ltd, 8 Wentworth Road, Heathfield Industrial Estate, Newton Abbot, Devon, TQ12 6TL**

Exported by/Exporté par/Exportado por/Exportiert von/Esportato da

Bestway (Hong Kong) International Ltd./Bestway Enterprise Company Limited

Suite 713, 7/Floor, East Wing, Tsim Sha Tsui Centre, 66 Mody Road, Kowloon, Hong Kong

www.bestwaycorp.com

Bestway®

FLOWCLEAR™



OWNER'S MANUAL

bestwaycorp.com/support

Visit the Bestway YouTube channel 



OWNER'S MANUAL

58381/58383/58386 Filter Pump



Visit the Bestway YouTube channel

IMPORTANT SAFETY INSTRUCTIONS

READ AND FOLLOW ALL INSTRUCTIONS

Carefully read, understand, and follow all information in this user manual before installing and using the Filter Pump. These warnings, instructions, and safety guidelines address some common risks of water filtration systems, but they cannot cover all risks and dangers in all cases. Always use caution, common sense, and good judgment when enjoying any water activity. Retain this information for future use. In addition, the following information can be supplied depending on the Filter Pump type. Keep the instructions in a safe place. If instruction is missing, search it on the website www.bestwaycorp.com/support.

WARNING

- Electric installations should follow national wiring rules.
- The pump is to be supplied by an isolating transformer or supplied through a residual current device (RCD) having a rated residual operating current not exceeding 30 mA.
- The pump cannot be used while people are inside the pool.
- The supply cord cannot be replaced. If the cord is damaged the appliance should be scrapped.
- This appliance is not intended for use by persons (including children) with reduced physical, sensory or mental capabilities, or lack of experience and knowledge, unless they have been given supervision or instruction concerning use of the appliance by a person responsible for their safety. Children should be supervised to ensure that they do not play with the appliance.
- If instruction is missed, please contact with Bestway or search it in website: www.bestwaycorp.com

TECHNICAL SAFETY INSTRUCTIONS

- The appliance must be supplied by an earthed power source.
- Extension cords can't be used.
- Do not bury cord. Locate cord to minimize abuse from lawn mowers, hedge trimmers, and other equipment.
- This pump is for use with storable pools only. Do not use with permanently-installed pools. A storable pool is constructed so that it is capable of being readily disassembled for storage and reassembled to its original integrity. A permanently-installed pool is constructed in or on the ground or in a building such that it cannot be readily disassembled for storage.
- Using the pump with an unmatched electrical supply is dangerous and will result in catastrophic failure of pump.
- When working with electricity, turn the electrical power off at the circuit breaker and lock breaker door. Failure to do so will result in increased risk of shock, injury and possibly death.
- Do not remove the grounding prong or modify the plug in any way. Do not use adapter plugs. Consult a qualified electrician for any questions related to the validity of your plug's grounding. Handle the pump with care. Do not pull or carry the pump by the power cord. Never pull a plug from the outlet by yanking the power cord. Keep cord free from abrasions. Sharp objects, oil, moving parts, and heat should never be exposed to the filter pump.
- Read the instructions before using the appliance and installation/reassemble each time.
- Cleaning and user maintenance must be performed by an adult above 18 years old who is familiar with the risk of electric shock.
- It is necessary to have the plug accessible after installation of the pool.
- Atmospheric conditions may affect the performance and life span of your filter pump. Unnecessary wear and tear may occur during periods of cold, heat and exposure to sun. Whenever possible, shelter the pump from these conditions.
- It is important to ensure the factory equipped stopper plugs for the inlet and outlet ports replace the screens before removal or maintenance on the pump is attempted.
- Do not add chemicals in the filter pump.
- Don't plug or unplug the appliance if your hand is wet.
- Always unplug the appliance: on rainy days, before cleaning or other maintenance, and when leaving it unattended on holidays.
- When the appliance will be not used for long time, such as in the winter, the pool set should be disassembled and stored indoor.
- This product is not intended for commercial use.

SAVE THESE INSTRUCTIONS

ATTACHING A BASE

FOR 330GAL

IEC60335-2-41 TEST standard requires the filter pump to be vertically fixed on the ground or a base made of wood or concrete before use. There should be two holes 9 mm in diameter on the base, the space between which should be 127 mm. Put filter pump on the base and attach them together by fastening the bolts and nuts. All the base parts should weigh at least over 18 kg to prevent the pump from accidentally falling.

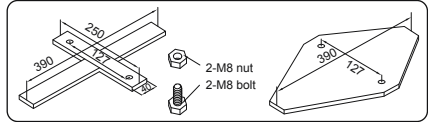

FOR 530GAL

IEC60335-2-41 TEST standard requires the filter pump to be vertically fixed on the ground or a base made of wood or concrete before use. There should be two holes 9 mm in diameter on the base, the space between which should be 159 mm. Put filter pump on the base and attach them together by fastening the bolts and nuts. All the base parts should weigh at least over 18 kg to prevent the pump from accidentally falling.

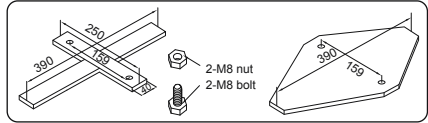

FOR 800GAL

IEC60335-2-41 TEST standard requires the filter pump to be vertically fixed on the ground or a base made of wood or concrete before use. There should be two holes 9 mm in diameter on the base, the space between which should be 166 mm. Put filter pump on the base and attach them together by fastening the bolts and nuts. All the base parts should weigh at least over 18 kg to prevent the pump from accidentally falling.

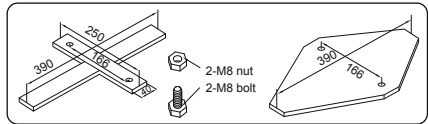

SETUP

CHECK LIST

To check the parts included in the box, consult the part list inside this manual. Verify that the equipment components represent the model that you had intended to purchase. In case of any damaged or missing parts at the time of purchase, visit our website bestwaycorp.com/support.

CHOOSE THE CORRECT LOCATION

Place the Filter Pump on a solid and level ground; it must be positioned on the same level as the base of the pool. If the Filter Pump is in an upper or lower position than the base of the pool, the performance and life span of the Filter Pump can be compromised. The pool and the Filter Pump have to be positioned in an area with adequate drainage and easy access for maintenance operations. Never place the Filter Pump in a area that may accumulate water.

INSTALLATION

- For the installation instructions, refer to the illustration steps  inside the manual. Drawings are for illustration purposes only. May not reflect actual product. Not to scale.
- Bestway will not be responsible for any damage caused to the Filter Pump due to mishandling or failure to follow these instructions.
- It is imperative to check that the hydraulic connectors are not obstructed.
- Do not dry run the Filter Pump. Make sure both the pool's inlet and outlet valves are fully covered by water before operating the Filter Pump.

MAINTENANCE

- Make sure that the Filter Pump is unplugged before any maintenance.
- For the maintenance instructions, refer to illustration steps  inside the manual. Drawings are for illustration purposes only. May not reflect actual product. Not to scale.
- To optimize the Filter Pump performance and for sanitary reasons, we suggest replacing the filter cartridge with a new one every two weeks.

STORAGE

- Remove all accessories; be sure that Filter Pump, hoses and debris screens are completely clean and dry before the storage. If all the parts are not completely dry, mold may result.
- Before storage, remove and dispose of the filter cartridge.
- We strongly recommend disassembling the Filter Pump when the environment temperature is below 10°C / 50°F.
- Store the Filter Pump in a dry place with a moderate temperature between 10°C / 50°F and 38°C / 100°F.

WARRANTY TERMS

For information concerning warranty terms, visit our website at: www.bestwaycorp.com.

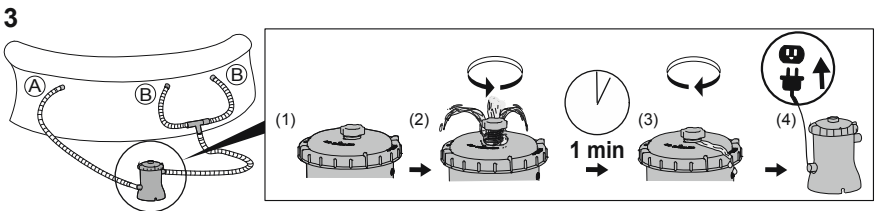
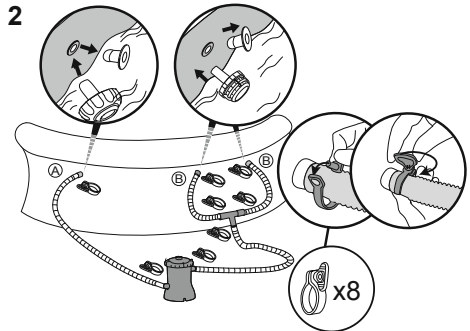
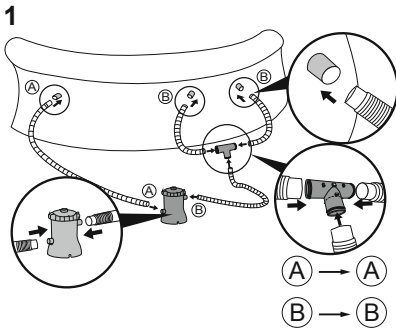
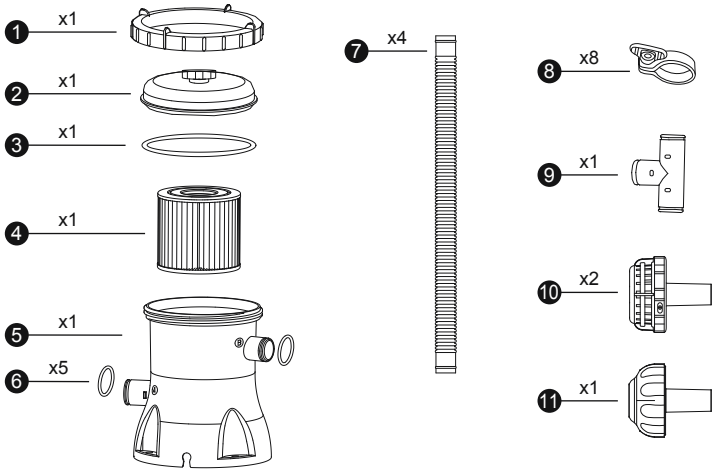



For support please visit us at:
bestwaycorp.com/support

©2022 Bestway Inflatables & Material Corp.

All rights reserved/Tous droits réservés/Todos los derechos reservados/Alle Rechte vorbehalten/Tutti i diritti riservati

Trademarks used in some countries under license from/

Marques utilisées dans certains pays sous la licence de/

Marcas comerciales utilizadas en algunos países bajo la licencia de/

Die Warenzeichen werden in einigen Ländern verwendet unter Lizenz der/

Marchi utilizzati in alcuni paesi concessi in licenza a

Bestway Inflatables & Material Corp., Shanghai, China

Manufactured, distributed and represented in the European Union by/

Fabriqués, distribués et représentés dans l'Union Européenne par/Fabricado, distribuido y representado en la Unión Europea por/

Hergestellt, vertrieben und in der Europäischen Union vertreten von/Prodotto, distribuito e rappresentato nell'Unione Europea da

Bestway Europe S.p.a., Via Resistenza, 5, 20098 San Giuliano Milanese (Milano), Italy

Distributed in Latin America by/Distribué en Amérique latine par/Distribuido en Latinoamérica por/Distribuido na América Latina por

Bestway Central & South America Ltda, Salar Ascotan 1282, Parque Enea, Pudahuel, Santiago, Chile

Distributed in Australia & New Zealand by **Bestway Australia Pty Ltd, Unit 2/98-104 Carnarvon St Silverwater, NSW 2128, Australia**

Tel: Australia: (+61) 2 9037 1388; New Zealand: 0800 142 101

Distributed in United Kingdom by **Bestway Corp UK Ltd, 8 Wentworth Road, Heathfield Industrial Estate, Newton Abbot, Devon, TQ12 6TL**

Exported by/Exporté par/Exportado por/Exportiert von/Esportato da

Bestway (Hong Kong) International Ltd./Bestway Enterprise Company Limited

Suite 713, 7/Floor, East Wing, Tsim Sha Tsui Centre, 66 Mody Road, Kowloon, Hong Kong

www.bestwaycorp.com