

anko

Remote Control Pedestal Fan User Manual



Model No.: HEG45R (Black) and HEG45RW (White)
230 - 240V~ 50Hz 50W
Rev 6

Note: The specifications and/or components of this appliance are subject to change without prior notice.

1	Safety Instructions	4
2	Components	6
3	Assembly	7
3.1	Base and Stand	7
3.2	Attach Head to Stand	8
3.3	Safety Grille and Fan Blade	9
4	Instructions for Use	12
4.1	Head Tilt	12
4.2	Height Adjustment	12
5	Remote Control	13
6	Operation	14
6.1	Using the Fan	14
6.2	Fan Modes	15
6.2.1	Normal Mode	15
6.2.2	Natural Mode	15
6.2.3	Sleep Mode	15
6.3	Timer	16
6.4	Oscillating (Swing) Function	16
7	Care and Cleaning	17
8	Storage	17
9	Warranty Against Defect	18

1 Safety Instructions

When using electrical appliances, basic safety precautions should always be followed, including the following:

- Carefully read this instruction manual before using appliance. 
- Ensure that the fan is switched off from the supply mains before removing the guard.
- Keep appliance out of reach of young children.
- This appliance is not intended for use by persons (including children) with reduced physical, sensory or mental capabilities, or lack of experience and knowledge, unless they have been given supervision or instruction concerning use of the appliance by a person responsible for their safety.
- Children should be supervised to ensure that they do not play with the appliance.
- Ensure children and babies do not play with plastic bags or any packaging materials.
- Do Not disassemble the appliance. There are no user serviceable parts inside.
- **VERY IMPORTANT:**
Ensure that appliance does not get wet (water splashes etc.).
Do not use appliance with wet hands.
Do not immerse appliance in water or other liquids or use near sinks, baths or showers.
- Always operate the appliance from a power source of the same voltage, frequency and rating as indicated on the product identification plate.
- Position the power supply lead properly so that they will not be walked on or pinched by items placed on or against them.
- Use appliance only for its intended use. Appliance is intended for household use only and not for commercial or industrial use.
- Do not use appliance if it has been dropped or any part of appliance (including cord or plug) has been damaged.
- If the supply cord is damaged, it must be replaced by the manufacturer, its service agent or similarly qualified persons in order to avoid a hazard.
- The use of accessories not intended for use with this appliance may cause injuries to the user or damage to the appliance.
- Do not install the unit on other appliances, on uneven surfaces or where it could be subject to: heat sources (e.g. radiators or stoves), direct sunlight, excessive dust or mechanical vibrations.

- Appliance should not be used outdoors, placed near a hot gas or electrical burner or placed in a heated oven.
- Do not install near any heat sources such as radiators, heat registers, stoves, or other apparatus that produce heat.
- Do not hang or wall-mount the appliance.
- Do not operate appliance underneath or near flammable or combustible materials (e.g. curtains). Keep at least 300mm clearance around sides, back, front and top.
- Do not allow curtains, drapes or any other items to drape across the appliance or openings.
- Unplug this apparatus during lightning storms or when unused for long periods of time.
- Do not block any ventilation openings.
- Never insert fingers or any other objects through the fan guard and ventilation openings.
- Do not use the product in oily or dirty areas (i.e. the kitchen, smoky place, etc), as the air vents may become blocked.
- Turn off and unplug before cleaning or storing.
- For cleaning, refer to section “Care and Cleaning” in this instruction manual.
- There are no user serviceable parts in this appliance.
- If this appliance is used by a third party, please supply the instruction manual with it.
- Do not misuse the cord. Never carry the appliance by the cord or pull to disconnect it from the outlet. Instead, grasp the plug and pull to disconnect.
- Do not insert or allow foreign objects to enter the grille openings as this may cause damage to the appliance and/or injury to the user.
- No liability can be accepted for any damage caused by non-compliance with these instructions or any other improper use or mishandling of appliance.

Additional Safety Instructions

If using an extension cord:

- The technical specifications of the extension cord must match or exceed the technical specifications of this appliance.

- Do not allow the cord to hang over the edge of the work surface or to come into contact with stoves or other hot surfaces.
- If the cord or plugs are worn or damaged, do not use.
- Unplug from the power socket by grasping the plug body - Do Not pull on the cord.

Read and Save These Instructions

2 Components

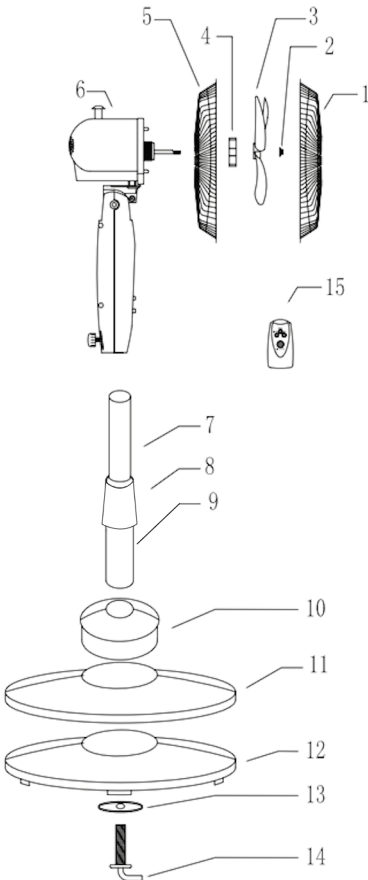

1	Front Grille
2	Fan Blade Spinner Nut
3	Fan Blade
4	Fan Guard Nut
5	Rear Grille
6	Motor Head Assembly
7	Inner chrome tube
8	Height Adjustment Ring
9	Stand Post
10	Plastic collar
11	Base Cover
12	Base Weight
13	Washer
14	Locking Screw
15	Remote Control

3 Assembly

3.1 Base and Stand

Your Fan has been boxed unassembled to minimise packaging waste. Each part is designed to fit together and be disassembled easily for cleaning or storage.

- First, unscrew the Locking Lever and Washer from the bottom of the stand post.
- Insert the plastic collar into the top of the plastic base cover.
- Insert the bottom of the stand post into the collar.
- Whilst holding the cover and post together, tip up so that the underneath of the cover is accessible.
- Place the Weight in the centre of the cover and over the end of the post.
- Fasten in place by use of the Locking Lever and Washer and tighten.

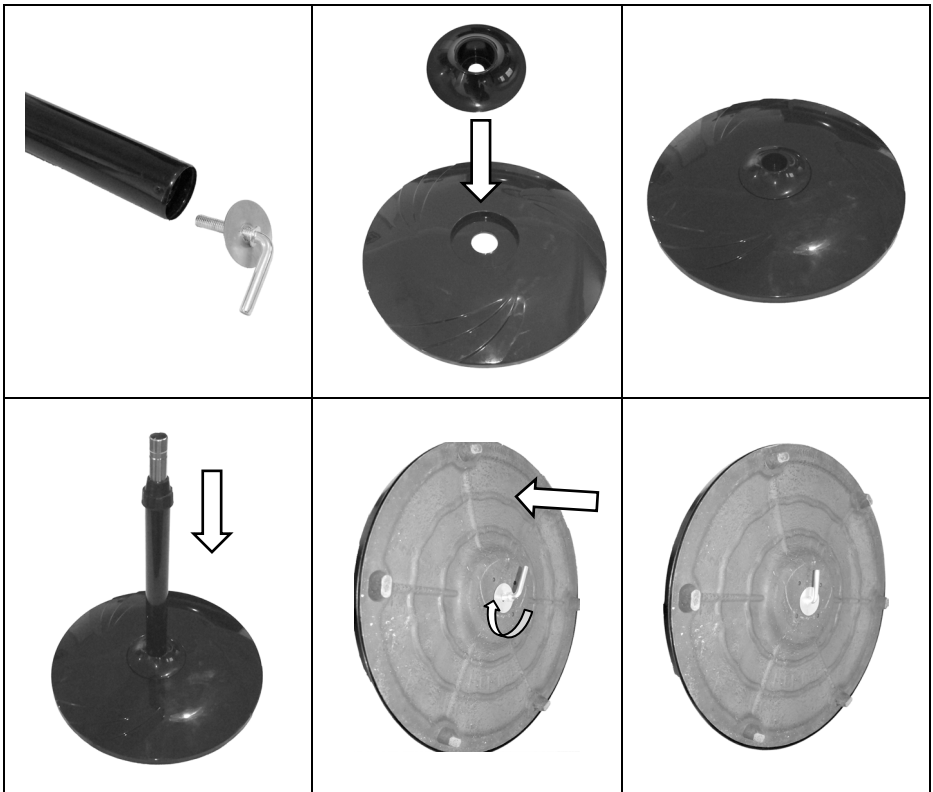

3.2 Attach Head to Stand

- Stand the Base with attached post on the floor.
- Loosen (anticlockwise) the post height adjustment locking ring, pull out the inner chrome tube to the desired height and then retighten the locking ring.
- Place Motor assembly at the top of the Stand Post and lower down all the way.

Note: if the motor assembly will not slide down the chrome post, loosed the thumb screw on the back of the motor assembly until it can slide down.

- Tighten the thumb screw (Clockwise). Do Not overtighten.

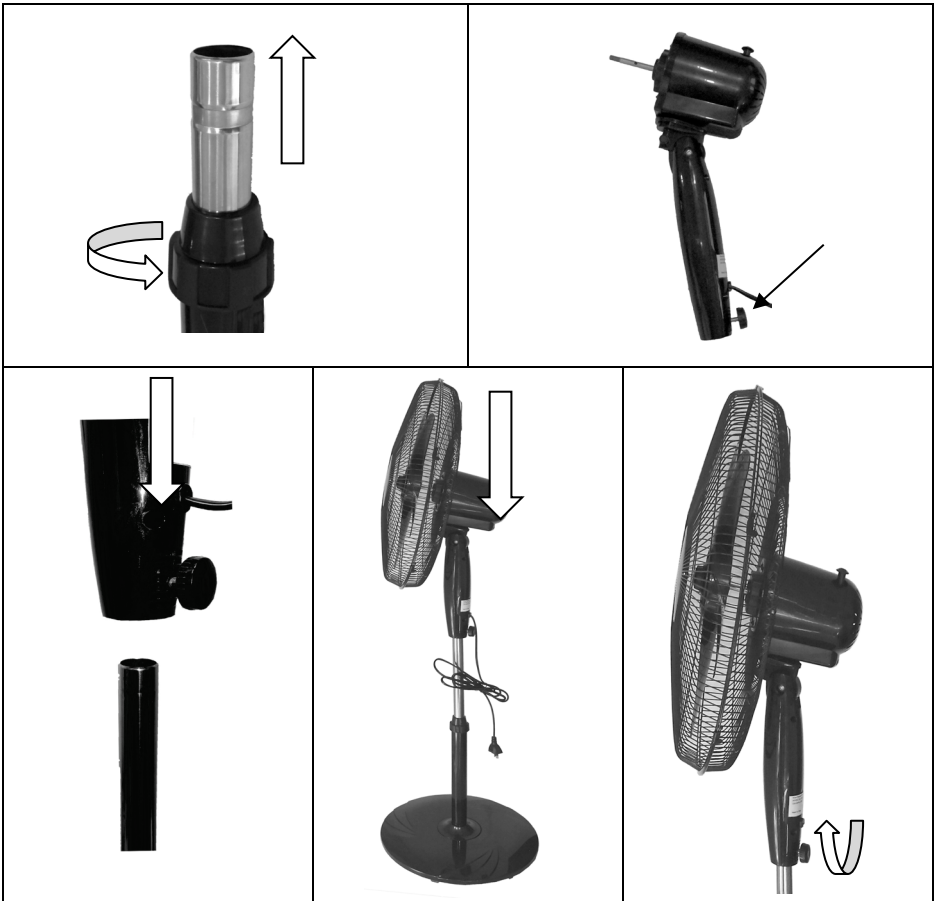

3.3 Safety Grille and Fan Blade

- To assemble the safety grille and blade assembly, first remove the Fan Guard Nut (Anticlockwise) from the front of the fan motor housing.

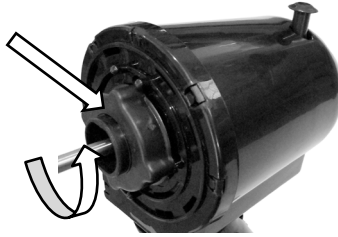

- Fit the rear safety grille into position (with the handle on the back of the grille at the top) and refit the Nut and tighten.

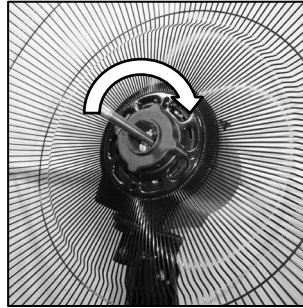
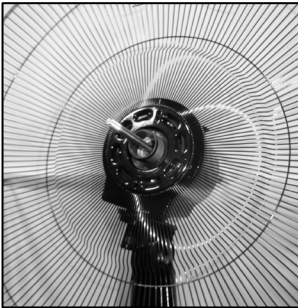

- If Fitted, remove the protective plastic sleeve from the motor spindle shaft and discard.
- Place the Fan Blade onto the motor spindle.

Note: The Motor shaft has a flat on one side and the hole in the centre of the fan blade also has a flat on one side. Ensure the two flats are aligned to enable the fan blade to be pushed on all the way.

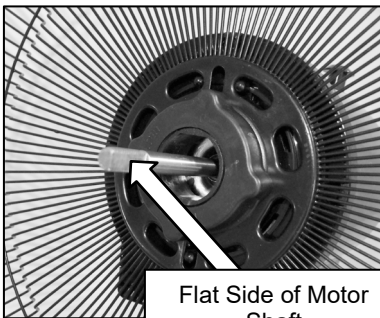

Flat Side of Motor Shaft

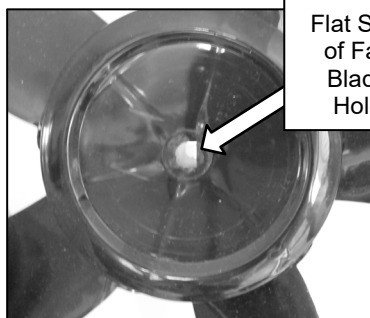

Flat Side of Fan Blade Hole

- Slide the fan blade all the way on.

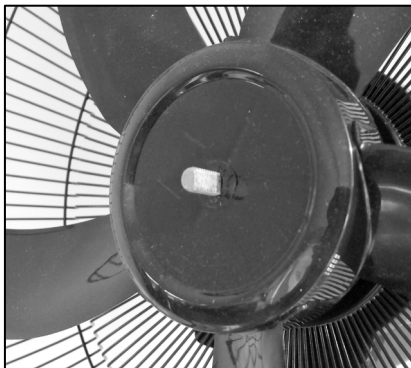

- Secure the blade into place by gently hand tightening the spinner nut **anticlockwise** onto the end of the motor spindle. The spinner nut is self-tightening when the motor starts, so do not over-tighten the spinner nut, just nip it up.

NOTE: The Spinner Nut screws on in the opposite way to a normal nut. It tightens when rotated Anticlockwise.

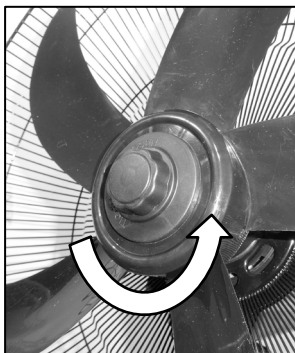

- Open up all locking clips on the sides of the front safety grille.

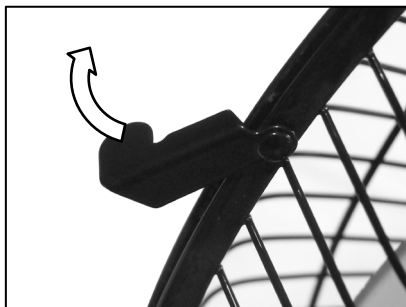

- Remove the small nut and bolt from the bottom of the grille

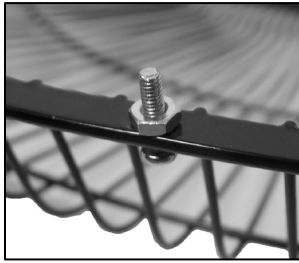

- Place the safety grille into position by lining up the location hook over the top of the rear grille as shown and push down.

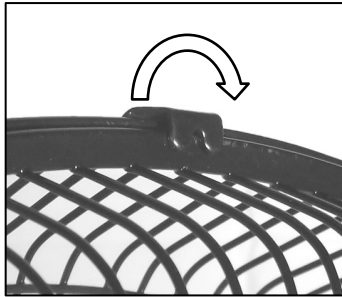

- Secure the grille by closing the clips over the outer rim.

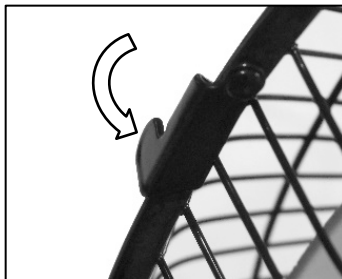

- Then insert the small bolt through the two holes in the bottom rim of both grilles, screw on the nut and use a small Philips screwdriver to tighten.

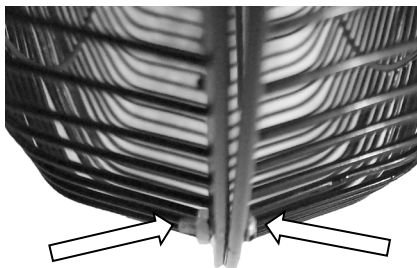

4 Instructions for Use

Remove the cable tie and unravel the cordset before operation.

DO NOT run the power cord under the stand

4.1 Head Tilt

The Fan Head can be adjusted Up and Down so as to blow air at the required angle.

Turn off and unplug prior to adjusting.

To adjust, grasp the Fan Grills and tilt the head either upward or downward to your desired angle.



4.2 Height Adjustment

The height of the fan can be adjusted.

Unscrew the adjustment ring (Anticlockwise) on the outside of the stand post, slide the inner post up or down and then tighten the knob (Clockwise) again to lock in place.

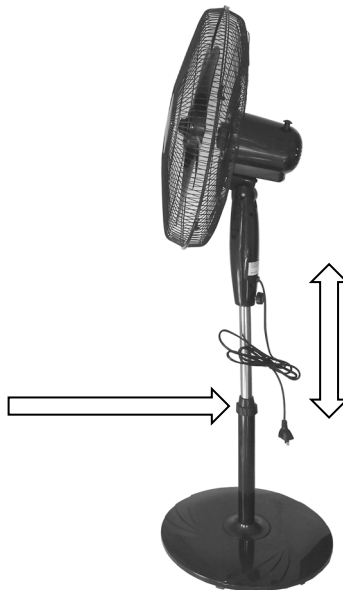

5 Remote Control

The remote control must be pointed towards the receiver, which is located inside the fan control panel, in order to work.

Do not block the line of sight between the remote control and the fans control panel.

Do not drop the remote control onto the floor or knock it against hard objects.



Note: Battery Type: “1.5V 2 x AAA” are not included.

- To install or remove the batteries, remove the back of the remote control by pressing down on the Thumb Grip, then sliding the battery cover down and lift off as shown.



- Insert the batteries inside the battery compartment matching polarity icons (+ and -) with those marked inside the battery compartment.

Place the flat “-“ end of the battery on the spring, push down on the spring and at the same time, push the top “+“ end of the battery into the remote control. Repeat for the other battery and then refit the cover securely by sliding it back on until it clips shut.

- To remove the batteries, using your fingernail or a plastic tool, pry the batteries out by pushing from the top (+ end) of the battery and then swing out as shown.



IMPORTANT:

Do Not mix new and old batteries or batteries of different types (e.g., Alkaline with Non-Alkaline) in the remote control.

To prevent corrosion, remove the batteries if the remote control will not be used over a lengthy period.

Non-rechargeable batteries are not to be recharged.

Exhausted batteries are to be removed from the remote control and safely disposed of.

The battery supply terminals are not to be short-circuited.

6 Operation

The functions of the fan can be operated using the supplied remote control. Basic function can also be controlled using the control panel.

Note: The Remote Control consists of the following functions: On/Speed, Timer, Mode and Off.

The Fan Control Panel consists of On/Speed and Off Functions.



Fan Control Panel



Remote Control

6.1 Using the Fan

The Fan has three speed settings: Low, Med and High.

- After ensuring the Fan has been assembled correctly, plug into the power point and switch on. The Red “Power” indicator will light up.
- Press the “ON/SPEED” button on the fan control panel or the remote control once. The “LOW” light and Mode light will illuminate. The fan will start to spin at Low Speed

Note: The Red Light for Mode indicates “Normal” continuous Fan Speed.

- For Medium Fan Speed, press the “ON/SPEED” button again. The MED light will illuminate and the fan will speed up.
- For High Fan Speed, press the “ON/SPEED” button again. The HIGH light will illuminate and the fan will speed up.

NOTE: Pressing the “ON/SPEED” button again will cycle the speed back to LOW, and so on.

- To turn the fan off, press button “OFF” Button on the remote control or on the fan control panel.

6.2 Fan Modes

The Fan has three modes being: Normal, Natural, and Sleep.

NOTE: Modes can only be selected with the remote control by pressing the “Mode” button.

With the Fan running in “Normal” mode (Red Mode Light), press the “MODE” button on the remote control and the mode will change to “Natural” mode (Green Mode Light).

Press the “MODE” button again and the mode will change to “Sleep” mode (Mode Light will turn Off).

Press the “MODE” button again, and it will cycle back to “Normal” mode. (Red Mode Light)

6.2.1 Normal Mode

The “Normal” Mode (Red Light) is set by default when the unit is first turned on. The wind remains a constant flow.

6.2.2 Natural Mode

The “Natural” mode (Green Light) creates variable Wind Patterns so as to simulate the variable winds that you would experience outdoors.

In this mode the speed of the fan continually cycles through a mixed selection of low, medium, high and off in set intervals.

Depending on which Fan Speed is selected, the wind pattern will be different

6.2.3 Sleep Mode

The “Sleep” mode (No Mode Light) creates wind patterns that are the same as the Natural Mode wind patterns, however, when the fan is set to either Medium or High Speed, the pattern will drop a speed level after approximately 30 minutes.

For Example: If High Speed Fan and the Sleep Mode is selected, this will be the same wind pattern as High Speed setting in Natural Mode. However, after approximately 30 minutes, the wind pattern will automatically drop down to the same wind pattern as if Natural Mode was selected at Medium fan speed.

After approximately a further 30 minutes, the wind pattern will automatically drop down to the same wind pattern as if Natural Mode was selected at low fan speed.

The fan will continue to run in the Low Speed Natural Mode until manually turned off.

Note: To have the fan automatically turn off at your desired time in this mode, use the “Timer” function to select the auto off timer.

6.3 Timer

Use this power-saving feature if you want the appliance to turn off automatically.

To select the Off time, press the “TIMER” button on the remote control once. It will advance to 0.5h as indicated by the indicator lights. The fan will turn off after approximately 0.5 hours

Each consecutive press will advance the timer at 0.5h increments until it reaches a maximum time of 7.5h.

The time set will be indicated by the sum of the lights which are illuminated. i.e. if the 0.5h + 2h + 4h lights are illuminated, this adds up to 6.5 hours. The fan will turn off after approximately 6.5 hours

To turn off the timer, or to reset to a new time, continue to press the “TIMER” button until it cycles back to where no timer lights are illuminated.

Press the “OFF” button to turn the appliance off.

6.4 Oscillating (Swing) Function

The fan is fitted with an Oscillating function where when activated, the fan head will swing from side to side.

Push the clutch knob down to activate the oscillating function. The fan head will swing from side to side whilst blowing air.

To stop the oscillation, allow the Fan head to move into the desired position and then pull the clutch knob up.



Note: The head can be manually rotated left or right to align the head with the centre of the “swing” by means of a ratchet system. Do Not force it beyond where it stops physically stops.

7 Care and Cleaning

- Ensure that the fan is switched off from the supply mains before removing the guard.
- Turn off and unplug the unit prior to cleaning.
- Clean the motor housing and body assembly with a clean, damp cloth and wipe dry.
- Never spray with liquids or submerge the Fan in water or any other liquid.
- Do not use flammable liquids, chemicals, abrasive creams, steel wool or scouring pads for cleaning.

8 Storage

Switch off and unplug the fan.

Coil the cable loosely. Do not kink or pull the cable tight.

Store your fan in a cool, dry location.

9 Warranty Against Defect

12 Month Warranty

Thank you for your purchase from Kmart.

Kmart Australia Ltd warrants your new product to be free from defects in materials and workmanship for the period stated above, from the date of purchase, provided that the product is used in accordance with accompanying recommendations or instructions where provided. This warranty is in addition to your rights under the Australian Consumer Law.

Kmart will provide you with your choice of a refund, repair or exchange (where possible) for this product if it becomes defective within the warranty period. Kmart will bear the reasonable expense of claiming the warranty. This warranty will no longer apply where the defect is a result of alteration, accident, misuse, abuse or neglect.

Please retain your receipt as proof of purchase and contact our Customer Service Centre 1800 124 125 (Australia) or 0800 945 995 (New Zealand) or alternatively, via Customer Help at Kmart.com.au for any difficulties with your product. Warranty claims and claims for expense incurred in returning this product can be addressed to our Customer Service Centre at 690 Springvale Rd, Mulgrave Vic 3170.

Our goods come with guarantees that cannot be excluded under the Australian Consumer Law. You are entitled to a replacement or refund for a major failure and compensation for any other reasonably foreseeable loss or damage. You are also entitled to have the goods repaired or replaced if the goods fail to be of acceptable quality and the failure does not amount to a major failure.

For New Zealand customers, this warranty is in addition to statutory rights observed under New Zealand legislation.

IMPORTANT!

For all technical queries or difficulties in operating the product and for spare parts, contact H.E. Group customer service 1300 105 888 (Australia) and 09 8870 447 (New Zealand).

Please refer to the Instruction Manual for more details and images of the assembly procedure.

STEP 1: SET UP BASE AND STAND

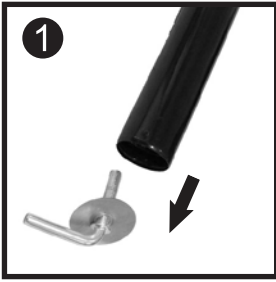

Unscrew the **Locking Lever** and **Washer** from the bottom of the stand post.

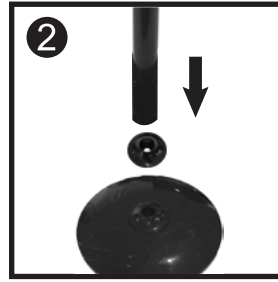

Insert the **Plastic Collar** into the top of the plastic base cover. Insert the bottom of the **Stand Post** into the collar.

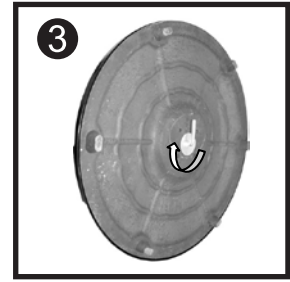

Tilt the **Base** and place the **Weight** in the centre of the base. Fasten in place by use of the **Locking Lever** and **Washer** and tighten.

STEP 2: ATTACH HEAD TO STAND



Loosen (anticlockwise) the post height adjustment **Locking Ring**, pull out the inner chrome tube to the desired height and then retighten the locking ring.



Place **Motor Assembly** at the top of the Stand Post and lower down all the way.

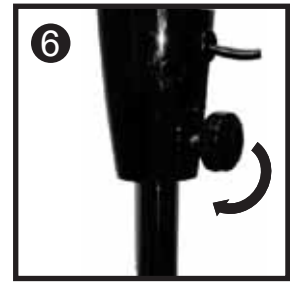

Screw in the **Locking Knob** (Clockwise) and nip up. Do Not overtighten.

STEP 3: INSTALL SAFETY GRILLE AND FAN BLADE

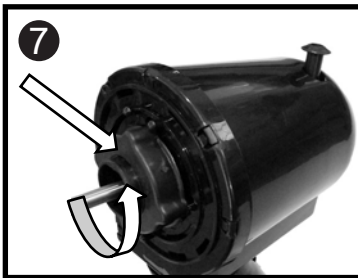

Unscrew the **Locking Nut** (anticlockwise) on **Motor Assembly**.

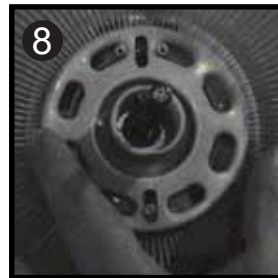

Place the **Back Safety Grille** into position ensuring the safety grille fits onto the locating lugs. (*Note: The handle on the back of the grille will be at the top if this is done correctly.)

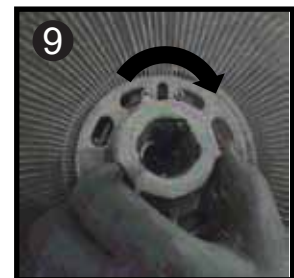

Fix the back safety grille into position by screwing the **Locking Nut** (clockwise) tightly by hand. (Note: Do not over tighten the locking nut.)

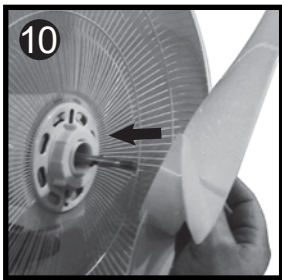

Remove the protective plastic sleeve from the motor spindle shaft. Place the **Fan Blade** onto the motor spindle. (Ensure the two flats are aligned.)

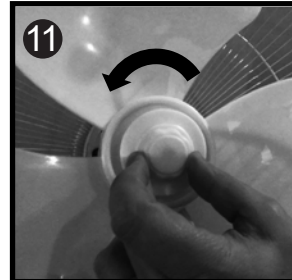

Fix the blade into place by gently hand tightening the **Spinner Nut** (anticlockwise) onto the end of the motor spindle.

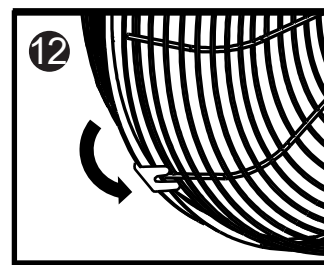

Place the **Front Safety Grille** into position (with the location hook over the top of the rear grille) and secure it by closing the clips over the outer rim.

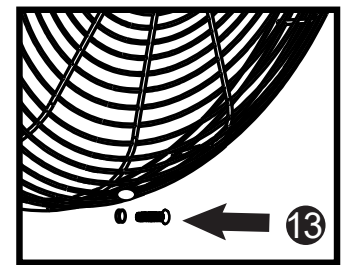

Using the **Small Nut and Bolt**, fasten the two grilles together.

If you are missing a part or having troubles when assembling the fan, please feel free to call our friendly customer service team on our toll free number: 1300 105 888 or via email info@hegroup.com.au. We will be glad to assist you.