

# anko

## 10kg Top Load Washing Machine Quick Start Guide



Model no: ATLW100G

Rev: 03

# A simple guide to start using your 10kg Top Load Washing Machine

## › Quick Start Steps

Before Washing

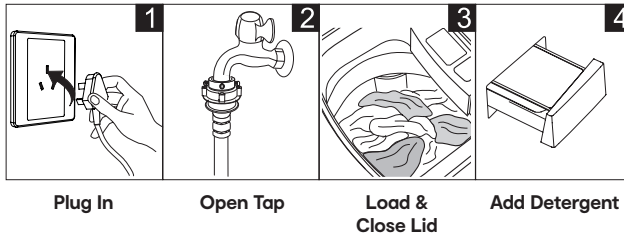

Plug In

Open Tap

Load &  
Close Lid

Add Detergent

Note: Before washing, please make sure the unit is installed properly and that the washing machine completes one full cycle without any clothes in it.

To Start a Cycle

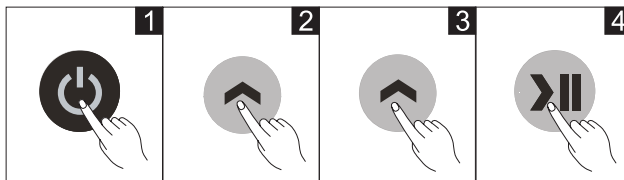

Power On

Select  
Program

Optional:  
Personalise Your  
Cycle

Press  
Start

To personalise your cycle select a washing program and use the Water Level, Function, Delay, Rinse and Temperature button to adjust any of these settings to suit your washing needs. For detailed operation instructions refer to Pages 8-15 in your User Manual.

## › Fast Mode Function

Use this setting to save between 20-40% of your cycle time by strengthening the washing beats.

To start up Fast Mode: Power on, select "Normal", "Soft", "Mix", "Strong" or "Jeans" program, then press FAST MODE button combinations [Program and Temperature].

## › Fuzzy Weighing

The washing machine will select the water level automatically according to the load weight.

After pressing the [Start/Pause] button (if there is no water in the drum), the washing machine will run the fuzzy weighing function automatically. You can also select the water level to adjust the water level as needed.

## › Product Specifications

Capacity	10kg
Dimensions (w,d,h)	601 x 630 x 1000mm
Net Weight	45kg
MEPS/WELS	2 Stars/3 Stars

## › Need Help?

For all questions or customer support please contact us using the details below.  
 Phone 1800 124 125 (Australia)  
 Online [www.kmart.com.au](http://www.kmart.com.au)

# anko

## Top Load Washing Machine 5.5kg, 8kg & 10kg (Automatic Washing Machine) Instruction Manual



Model no: ATLW55G,  
ATLW80G & ATLW100G  
Rev: 9.5

To ensure proper operation of this device, please read this instruction manual carefully before using the device and keep it for future reference.

# Purchase Details

For future reference, please record the following information which can be found on the rating plate and the date of purchase which can be found on your sales invoice.

---

## STORE DETAILS

---

STORE NAME | \_\_\_\_\_

ADDRESS | \_\_\_\_\_

TELEPHONE | \_\_\_\_\_ PURCHASE DATE | \_\_\_\_\_

---

## PRODUCT DETAILS

---

MODEL NO. | \_\_\_\_\_

SERIAL NO.\* | \_\_\_\_\_

<b>Contents</b>	<b>2</b>	<b>Purchase Details</b>
	<b>4</b>	<b>Safety Instructions</b>
	<b>6</b>	<b>Your Washing Machine</b>
	<b>8</b>	<b>Installation</b>
	<b>10</b>	<b>Operating Instructions</b>
	<b>16</b>	<b>Cleaning &amp; Maintenance</b>
	<b>18</b>	<b>Troubleshooting</b>
	<b>20</b>	<b>Technical Specifications</b>
	<b>22</b>	<b>Warranty</b>

# Safety Instructions

For your safety, the information in this manual must be followed to minimize the risk of fire or explosion, electric shock, or to prevent property damage, personal injury or loss of life.

- › This appliance is not intended for use by persons (including children) with reduced physical, sensory or mental capabilities or lack of experience and knowledge unless they have been given supervision or instruction concerning use of the appliance by a person responsible for their safety.
- › Children should be supervised to ensure that they do not play with the appliance.
- › If the supply cord is damaged, it must be replaced by the manufacturer, its service agent or similarly qualified persons in order to avoid a hazard.
- › The new hose-sets supplied with the appliance are to be used and that old hose-sets should not be reused.
- › The openings must not be obstructed by a carpet.

Model	Washing Capacity	Standard Water Pressure
ATLW55G	5.5kg	0.03MPa~0.8MPa
ATLW80G	8.0kg	0.03MPa~0.8MPa
ATLW100G	10.0kg	0.03MPa~0.8MPa

Explanation of the following signal words:

## WARNING!

This signal word indicates a potentially dangerous situation which may result in death or serious injuries unless it's avoided.

## CAUTION!

This signal word indicates a potentially dangerous situation which may result in slight or minor injuries or damage to property and the environment.

## NOTE!

This signal word indicates a potentially dangerous situation which may result in slight or minor injuries.

## WARNING!

### POTENTIAL ELECTRIC SHOCK

- › This appliance is for indoor use only.
- › **Do not position washing machine in a humid place.**
- › Do not insert your hands into running spin-dry tub.
- › If the spin-dry tub does not stop within 15 seconds after opening the cover, please stop using the machine and have it repaired.
- › Before performing any maintenance on the device, unplug the appliance from the mains.
- › Always unplug the machine and turn off the water supply after use. The max. inlet water pressure, in pascals. The min. inlet water pressure, in pascals.
- › To ensure your safety, power plug must be inserted into an earthed three-pole socket. Check carefully and make sure that your socket is properly and reliably earthed.
- › Make sure that the water and electrical devices must be connected by a qualified technician in accordance with the manufacturer's instructions and local safety regulations.

### RISK TO CHILDREN

- › The appliance can be used by children aged from 8 years and above and persons with reduced physical, sensory or mental capabilities or lack of experience and knowledge if they have been given supervision or instruction concerning use of the appliance in a safe way and understand the hazards involved. Children shall not play with the appliance. Cleaning and user maintenance shall not be made by children without supervision.
- › Animals and children may climb into the machine. Check the machine before every operation.
- › Young children should be supervised that they do not play with the appliance.
- › Machine may get very hot during the operation. Keep kids and pets far away from the machine during use and keep away from very wet rooms as well as in a room with explosive or caustic gas.

# Safety Instructions (Continued)

- › Remove all packaging before using the appliance. Otherwise, serious damage may result.
- › The washing machine with single inlet valve only can be connected to the cold water supply. The product with double inlet valves should be correctly connected to the hot water and cold water supply.
- › Plug must be accessible after installation.

## RISK OF EXPLOSION

- › Do not wash or dry articles that have been cleaned in, washed in, soaked in, or dabbed with combustible or explosive substances (such as wax, oil, paint, gasoline, degreasers, dry-cleaning solvents, kerosene, etc.) This may result in fire or explosion.
- › Before hand thoroughly rinse items of washing by hand.

## CAUTION!

### INSTALLING THE PRODUCT

- › This washing machine is for indoor use only.
- › It isn't intended to be built-in using.
- › The openings must not be obstructed by a carpet.
- › Washing machine shall not be installed in bath room or very wet rooms as well as in the rooms with explosive or caustic gases.
- › Remove all packaging and transport bolts before using the appliance. Otherwise, serious damage may result.
- › The washing machine with single inlet valve only can be connected to the cold water supply. The product with double inlet valves should be correctly connected to the hot water and cold water supply.
- › Plug must be accessible after installation.

## RISK OF DAMAGING THE APPLIANCE

- › Your product is only for home use and is only designed for the textiles suitable for machine washing.
- › Do not climb up and sit on top cover of the machine.
- › Do not lean against machine door.
- › Cautions during Handling Machine:
- › Transport bolts shall be reinstalled to the machine by a specialised
- › The accumulated water shall be drained out of the machine.
- › Handle the machine carefully. Never hold each protruded part on the machine while lifting. Machine door can not be used as the handle during the conveyance.
- › This appliance is heavy. Transport with care.
- › Please do not close the door with excessive force.
- › Do not wash carpets.

## OPERATING THE APPLIANCE

- › Before washing the clothes at first time, the product should be operated in one round of the whole procedures without the clothes inside.
- › Do not wash flammable and explosive or toxic solvents.
- › Do not use gasoline and alcohol etc. as detergents.
- › Please only select the detergents suitable for machine washing, especially for drum.
- › Make sure that all pockets are emptied. Sharp and rigid items such as coin, brooch, nail, screw or stone etc. may cause serious damages to this machine.
- › Please check whether the water inside the drum has been drained before opening its door.  
Please do not open the door if there is any water visible.
- › Be careful of burning when the product drains hot washing water.
- › Never refill the water by hand during washing.
- › After the program is completed, Please wait for two minutes to open the door.

# Your Washing Machine

## PRODUCT DESCRIPTION

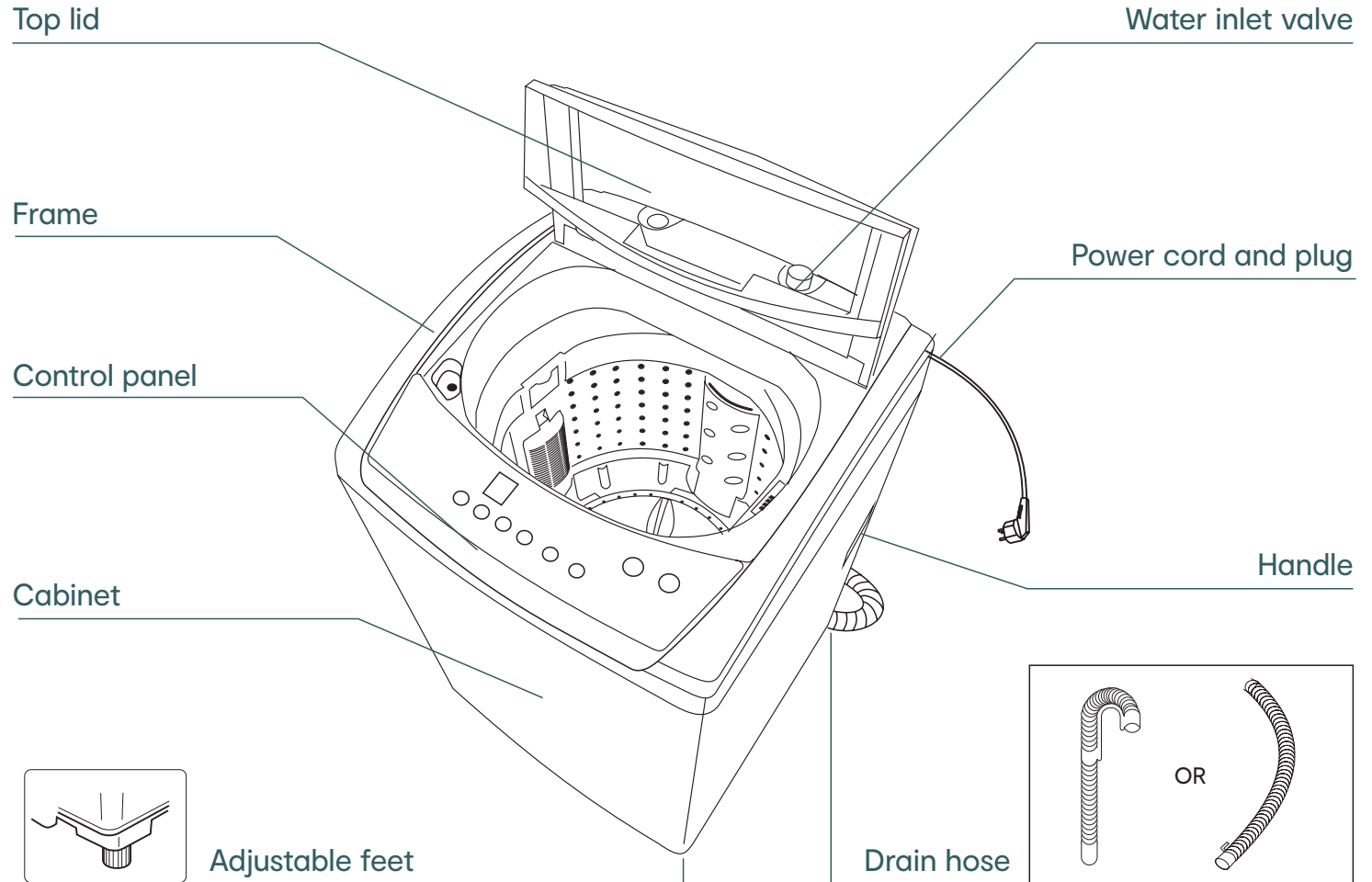

## NOTE!

The product line chart is for reference only, please refer to real product as standard.

## ACCESSORIES

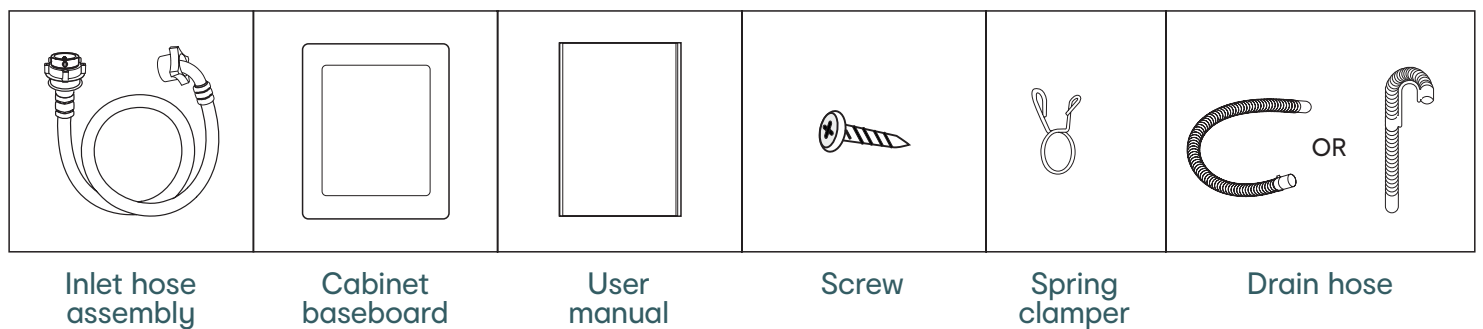

## NOTE!

If the drain hose is already installed on the machine, then there is no spring clammer and drain hose in the accessories.



# Installation

## INSTALLATION INSTRUCTIONS

It's recommended to use the washing machine on its own dedicated power outlet for both convenience and safety. The power outlet must be grounded.

### IMPORTANT!

If the power cord is damaged, it must be replaced by qualified electrical service representative. For service and repairs please contact Kmart customer service on 1800 124 125.

### WARNING!

- › Stability is important to prevent the product from moving!
- › Make sure that the product should not stand on the power cord.

Before installing the machine, the location must be:

1. Rigid, dry, and a level surface
2. Avoiding direct sunlight
3. Sufficient ventilation
4. Room temperature is above 0 °C
5. Kept far away from the heat resources such as coal or gas.

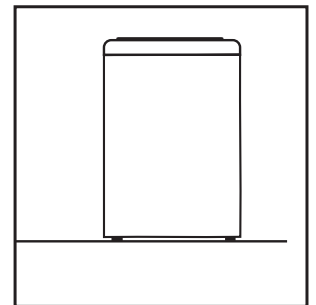
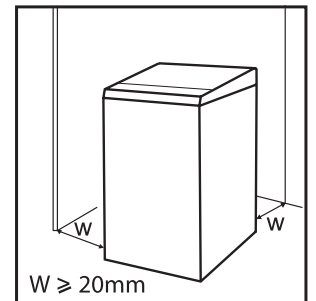

## UNPACKING THE WASHING MACHINE

### WARNING!

- › Packaging material (e.g. Films, Styrofoam) can be dangerous for children.
- › There is a risk of suffocation! Keep all packaging well away from children.

1. Remove the cardboard box and styrofoam packing.
2. Lift the washing machine and remove the base packing.
3. Remove the tape securing the power supply cord and drain hose.
4. Remove the inlet hose from the drum.

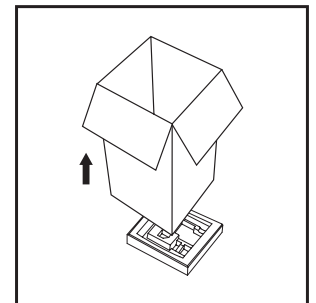

## INSTALLATION OF THE DRAIN HOSE

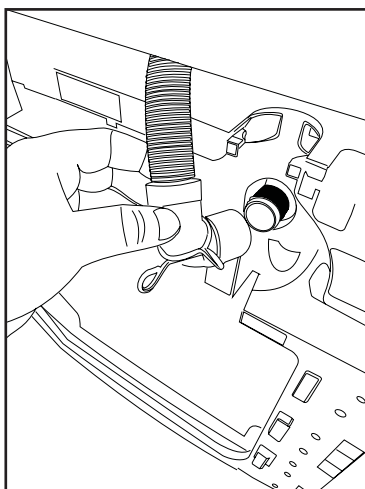

Drain hose inserted into the drain

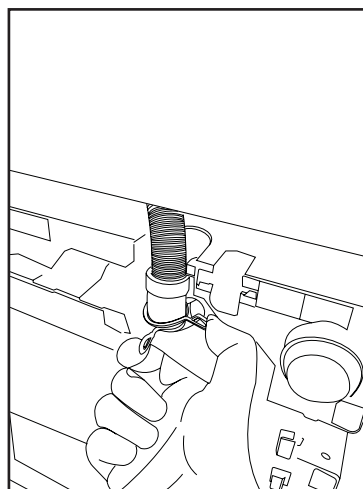

Clamping spring

# Operating Instructions

## WARNING!

To prevent leakage or water damage, follow the instructions in this chapter carefully:

- › Do not kink, crush, modify, sever or protract the inlet hose or drain hose.
- › Position drain hose properly, otherwise damage might result of water leakage.
- › If drain hose is too long, do not force it into washing machine as it will cause abnormal noises.

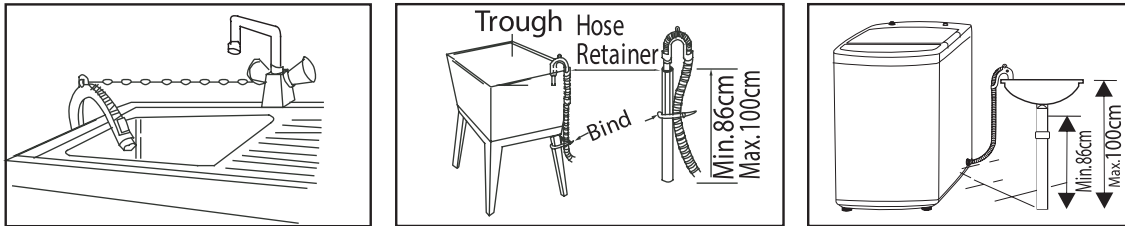

Use an upper drain system to place the end of drain hose:

## LEVELLING THE WASHING MACHINE

### WARNING!

The lock nuts on all four feet must be screwed tightly against the housing.

1. Check if the legs are closely attached to the cabinet. If not, please turn them to their original positions tighten the nuts.
2. Check alignment of the product with a spirit level and if required, correct.
3. Loosen the lock nut and turn the feet until it closely contacts with to the floor.
4. After being locked properly, press four corners again to make sure that they has been adjusted properly.

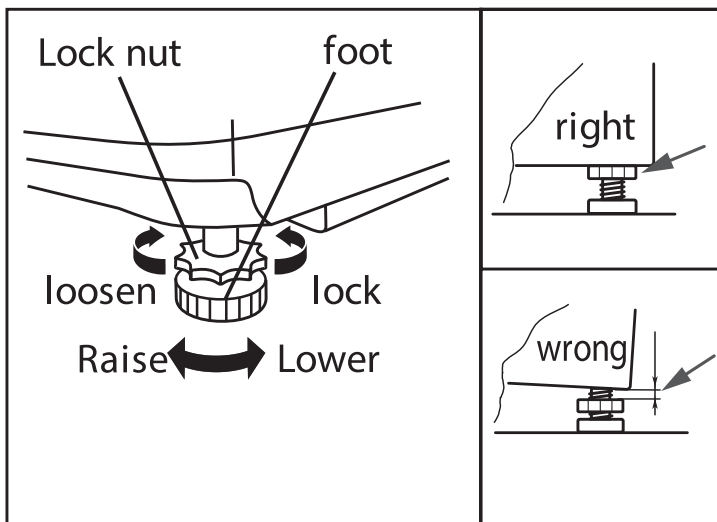

# Operating Instructions (Continued)

## SELECTION OF TAP

Please select appropriate tap.

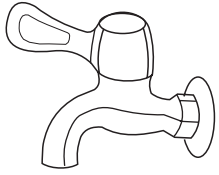

Ordinary faucet

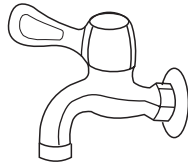

Screw tap

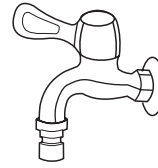

Special washing machine tap

## CONNECTION OF INLET HOSE, TAP AND WASHING MACHINE

### 1. Connection between ordinary tap and inlet hose.

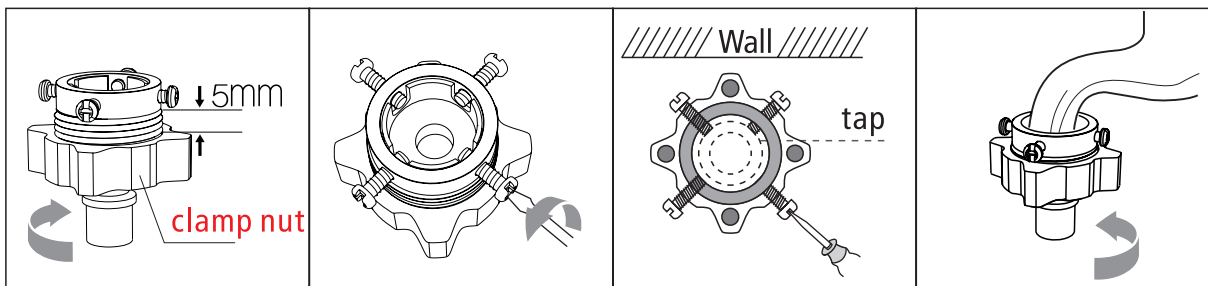

a) Loosen clamp nut to show 5mm thread

b) Loosen four bolts

c) Set connecting base on tap and tighten bolts evenly

d) Tighten clamp nut

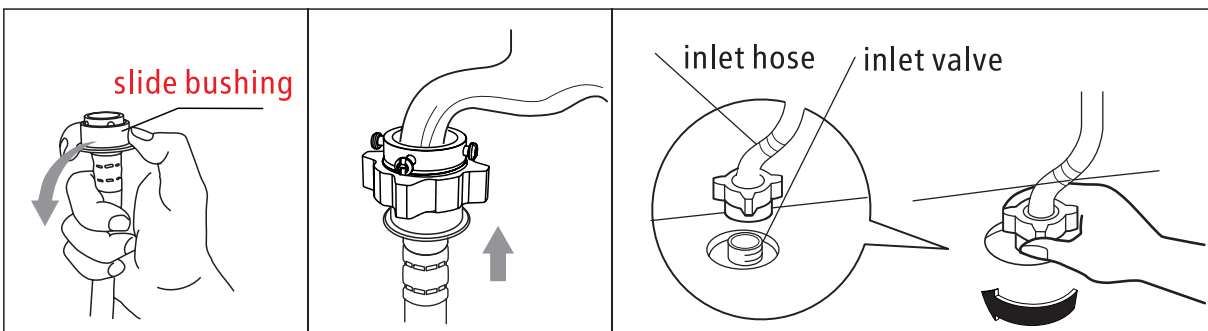

e) Press slide bushing, insert inlet hose into connecting base

f) Connection finished

g) After connection and installation, check if there is water leakage

### 2. Connection between screw tap and inlet hose.

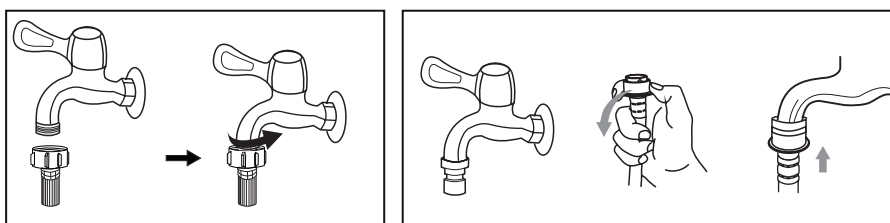

(tap with threads and inlet hose)

(special tap for washing machine)

# Operating Instructions (Continued)

## PREPARATION BEFORE WASHING

### CAUTION!

- › Before washing, please make sure it's installed properly.
- › Before washing it at first time, the washing machine shall be operated in one round of the whole procedures without clothes in as follows.

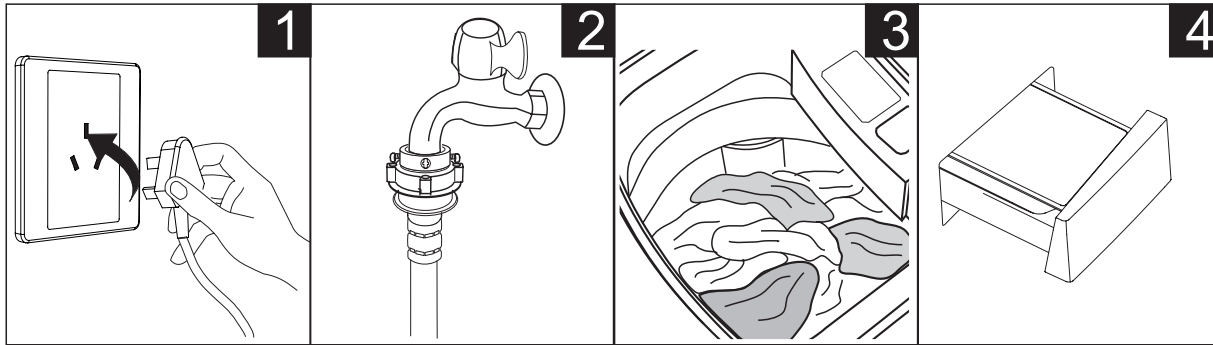

Plug in

Open tap

Load and Close door

Add detergent

## WASHING

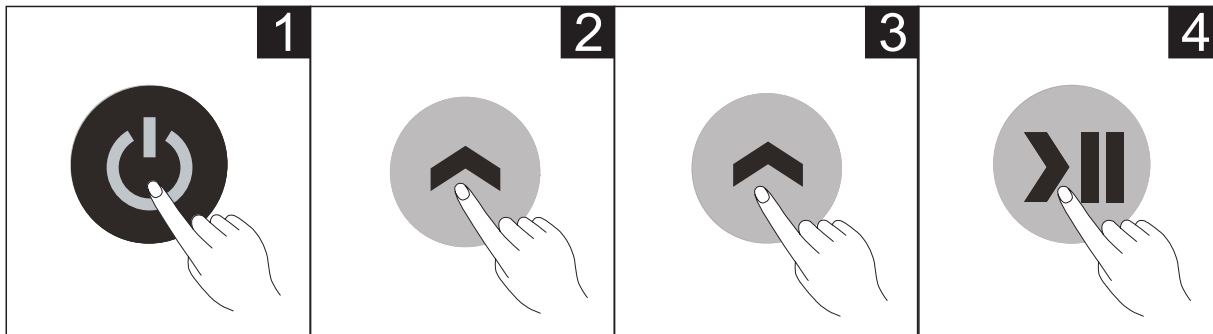

Power On

Select Program

Select Water Level

Start up

### NOTE!

- › If default is selected, step 2, 3 can be skipped.

## AFTER WASHING

Buzzer will beep after washing finished and the power supply will be cut off automatically. Then unload the laundry.

# Operating Instructions (Continued)

## WASHING MATTERS NEEDING ATTENTION

- › The working condition of the washer should be (0-40)°C. If used under 0°C, the inlet valve and draining system may be damaged. If the machine is placed under condition of 0°C or less, then it should be transferred to normal ambient temperature to ensure the water supply hose and drain hose are not frozen before use.
- › Please check the labels and the explanation of using detergent before wash. Use non-foaming or less-foaming detergent suitable for machine washing properly.

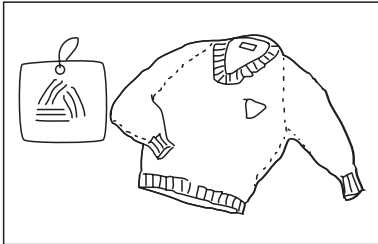

Check the label

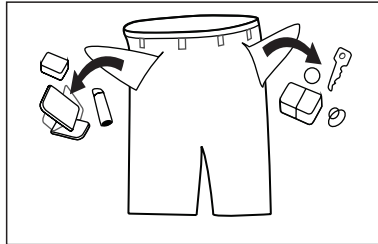

Take out the items out of the pockets

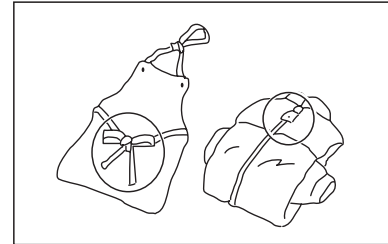

Knot the long strips, zip or button

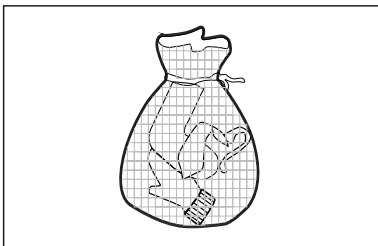

Put small clothes into the pillow slip

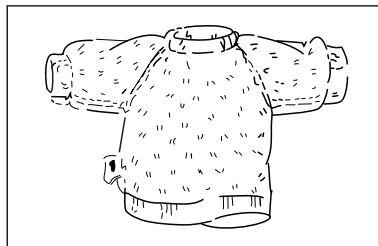

Turn easy-pilling and long-pile fabric inside out

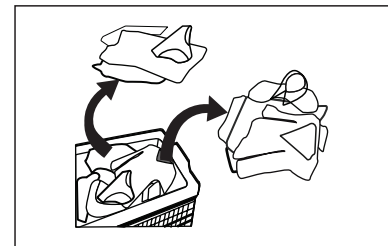

Separate clothes with different textures

## WARNING!

- › When washing a single clothes, it may easily cause great eccentricity and give alarm due to great unbalance. Therefore it is suggested to add one or two more clothes to be washed together so that draining can be done smoothly.
- › Don't washing the clothes touching with kerosene, gasoline, alcohol and other flammable materials.

## THE USAGE OF DETERGENT AND WASHING POWDER

- › Add liquid detergent to the left compartment of the detergent drawer.
- › Add power detergent to the right side compartment of the detergent drawer.
- › As for the agglomerated or ropy detergent or additive, before they are poured into the detergent box, it is suggested to use some water for dilution to prevent the inlet of detergent box from being blocked and overflowing while filling water.
- › Please choose suitable type of detergent for the various washing temperature to get the best washing performance with less water and energy consumption.

# Operating Instructions (Continued)

## NOTE!

- › This control panel is indicative of the 5.5kg model only, yours may appear differently.

### WATER LEVEL:

Select water level according to clothing categories, degree of soiling and washing habits of customers.

Press this button to set your Water Level, where 1 is low and 8 is high.

A solid indicator light indicates the water levels to the left (1, 3, 5, 7) and a flashing indicator light indicates the water levels to the right (2, 4, 6, 8).

### DISPLAY:

The display shows the settings, estimated time remaining, options, and status messages for your washer. The display will remain on through the cycle.

When LED flashing, it means the time that delay to start the machine. When LED lighting, it means the program time that remaining.

### CAUTION!

- › If there is any break in the power supply while the machine is operating, a special memory stores the selected program and when the power is restarted.

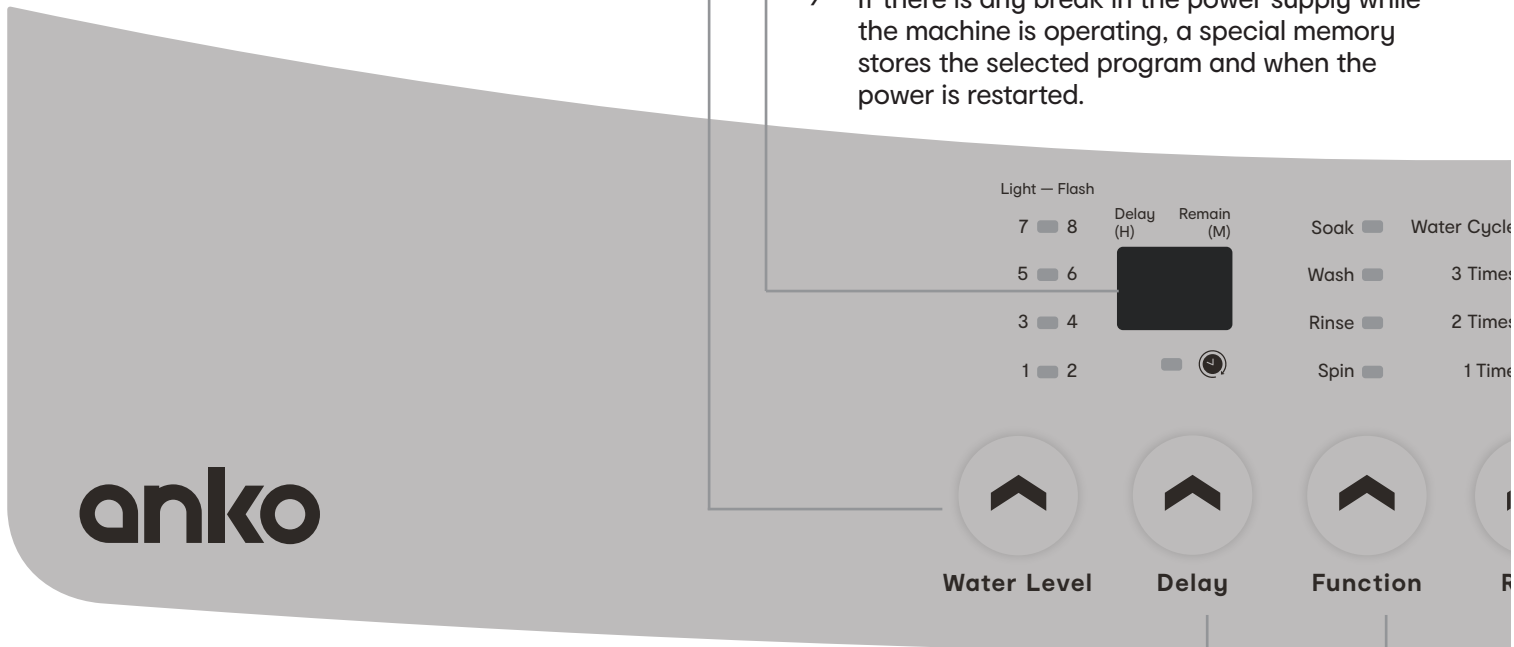

### DELAY:

After selecting a Program, press the Delay button to choose a delayed start time. Press **Start/Pause** to commence the delay operation.

To switch the delayed start off, simply press the button until the delay light is off. If the program has already started, press the **Power** button to reset the program.

### WASH FUNCTION:

Press this button to select your wash function. I.e. **Soak**, **Wash**, **Rinse** or **Spin**, or a combination of these.

# Operating Instructions (Continued)

## WATER TEMPERATURE:

Press this button to select your water temperature. When both the **Hot** and **Cold** indicators are lit, your washing machine will be set to use **Warm** water.

## START/PAUSE:

After selecting your desired wash settings, press this button to start your wash cycle.

You can also use this button to pause the washing machine during operation.

## POWER:

Press this button to turn your washing machine **On** or **Off**.

## RINSE:

Press this button to select your desired amount of times to rinse.

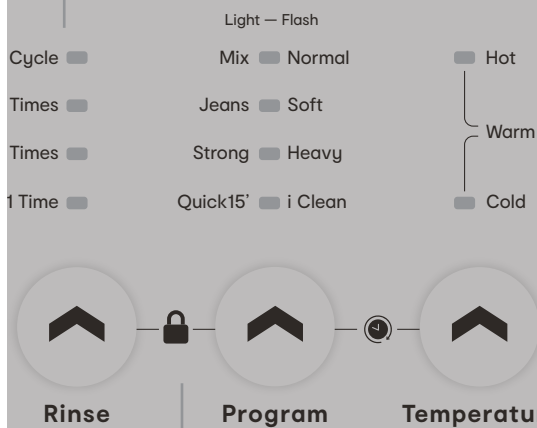

Start/Pause

Power

Rinse

Program

Temperature

## FAST MODE:

Fast Mode can save between 20–40% of your cycle time by strengthening the washing beats.

Simultaneously press the **Program** and **Temperature** buttons to activate Fast Mode. Repeat this process to deactivate Fast Mode.

## PROGRAM:

Press this button to select your wash program type. A solid indicator indicates the programs to the left, whereas a flashing indicator indicates the programs to the right.

## CHILD LOCK:

Simultaneously press the **Rinse** and **Program** buttons to activate the child lock. Repeat this process to deactivate the child lock.

## NOTE!

- › The Child Lock function will lock all buttons except **Power**.

# Operating Instructions (Continued)

## PERSONALISED WASH PROGRAM SETTING

Users can select washing program according to actual demand, set rinsing times, water volume and delay amount.

Power On → Program → Water Level → Function → Rinse → Temperature → Delay → Start

## OPERATIONS OF WASHING PROCESS

Users can set single process or combinations of washing, rinsing and spinning freely according to demand.

Detailed operations as follows for different models:

### ONE TOUCH SMART WASH

Power On → Start

### SPIN

Power On → Keep pressing the Function button until the Spin light is the only one on → Start

### WASH + RINSE + SPIN

Power On → Keep pressing the Function button until the Wash, Rinse and Spin lights are all on → Press Rinse separately, set desired setting → Start

### NOTE!

› There are other process combinations just like the above.



# Operating Instructions (Continued)

## WASHING PROGRAMS

- › **MIX**  
Suitable to wash cotton, linen, flax, jute clothes
- › **NORMAL (STANDARD)**  
Standard fabric washing program, suitable to wash ramie cotton fabric. Wash for once, rinsing for twice, the spin time is a little long.
- › **JEANS**  
Suitable to wash heavy stained/wearable clothes.
- › **SOFT**  
The tempo is soft, slow washing and spinning speed, to make the lightest wear and deformation.
- › **STRONG**  
The wash time is longer, the stream is stronger, so the washing effect is better.
- › **HEAVY**  
Suitable to wash heavy stained/wearable clothes.
- › **QUICK 15'**  
Suitable to wash light stained clothes and summer clothes.
- › **FAST MODE**  
Fast Mode can save between 20-40% of your cycle time by strengthening the washing beats.

Start up Fast Mode: Power on, select "Normal", "Soft", "Mix", "Strong" or "Jeans" program, then press FAST MODE button combinations.

Cancellation of Fast Mode function:

The function can be cancelled by pressing Fast Mode combination buttons (Program and Temperature) or Power off.

- › **FUZZY WEIGHTING**  
The washing machine will select the water level automatically according to the load weight.
  1. When there's water in the tub, this function is not available;
  2. Before pressing the [Start/Pause] button, if you chose to select the water level, there will be no fuzzy weighting function;
  3. After pressing the [Start/Pause] button, the washing machine will run the fuzzy weighing function automatically. You can also select the water level to set the water level as needed.

# Cleaning and Maintenance

## CLEANING AND CARE

### WARNING!

- › Before you begin maintenance, please unplug the machine and close the tap.

### CLEANING THE CABINET

Proper maintenance on the washing machine can extend its working life. The surface can be cleaned with diluted non-abrasive neutral detergents when necessary. If there is any water overflow, use the wet cloth to wipe it off immediately. No sharp items are allowed.

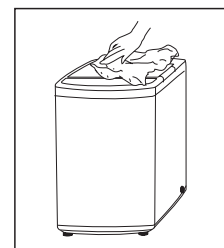

### NOTE!

- › Formic acid and its diluted solvents or equivalent are forbidden, such as alcohol, solvents or chemical products, etc.

## CLEANING THE INLET FILTER

### NOTE!

- › Inlet filter must be cleaned if there is less water.

Washing the filter in washing machine:

1. Screw off the inlet pipe from the rear of the machine.
2. Pull out the filter with long pliers and reinstall it back after being washed.
3. Use a brush to clean the filter.
4. Reconnect the inlet pipe.

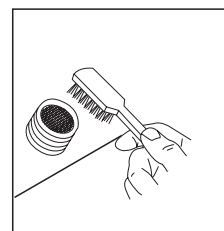
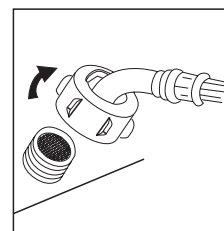

Lint filter clean:

1. There is a built-in lint filter in your washer. It can help to collect lint during washing cycle.
2. It is suggested to clean the lint filter every 10 cycles.
3. Take it out and clean the filter with water. Then place it back into the washer.

### Magic filter

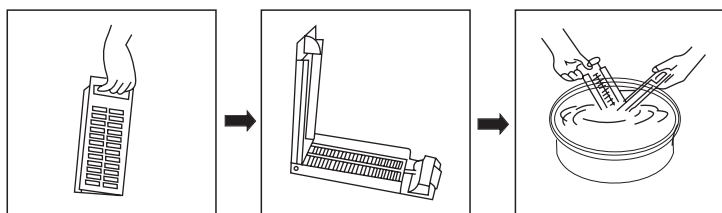

### Normal filter

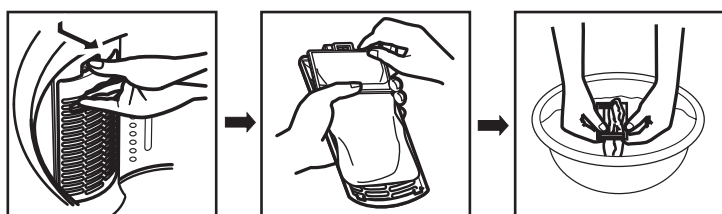

# Cleaning and Maintenance (Continued)

## CLEANING THE DRAIN PUMP FILTER (NOT APPLICABLE FOR MODEL ATLW55G)

### WARNING!

- › Be careful of the hot water!
- › Allow detergent solution to cool down.
- › Unplug the machine to avoid electrical shock before washing.
- › Drain pump filter can filter the yarns and small foreign matters from the washing.
- › Clean the filter periodically to ensure the normal operation of washing machine.

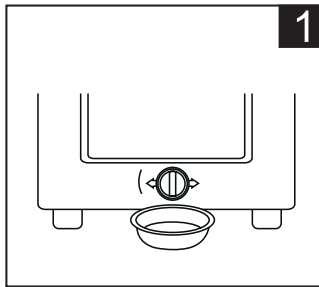

1  
Drain the water out of the pump, using a container to collect

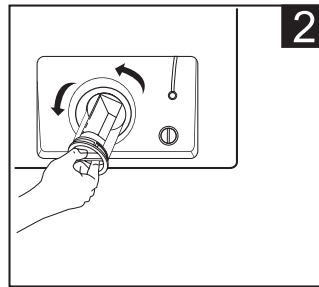

2  
Open the filter by turning to the counter clockwise

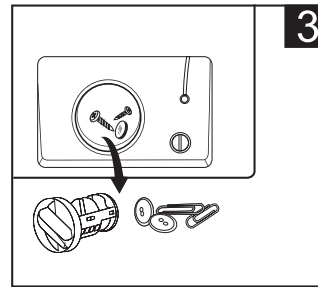

3  
Remove foreign objects

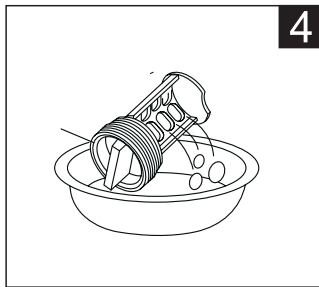

4  
Clean the filter

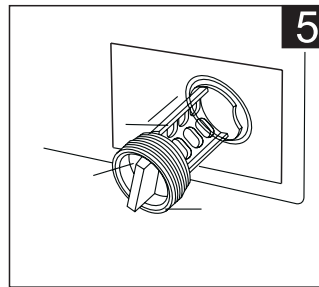

5  
Restore it and adjust the convex place to align at the pump hole

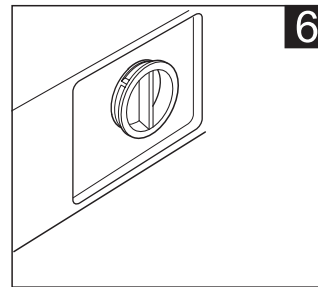

6  
Tighten the pump cover clockwise

### CAUTION!

- › Make sure that valve cap and emergency drain hose are reinstalled properly, cap plates should be inserted aligning to hole plates otherwise water may leak;
- › Some machines don't have emergency drain hose, so step 2 and step 3 can be skipped. Rotate lower cover cap directly to make water run into basin.
- › When the appliance is in use and depending on the program selected there can be hot water in the pump. Never remove the pump cover during a wash cycle, always wait until the appliance has finished the cycle, and is empty. When replacing the cover, ensure it is securely re-tightened.

# Troubleshooting

## OPERATION IN CASE OF EMERGENCY

In the event of an emergency you should:

- › Switch off all controls.
- › Switch the washing machine off at the power point or at the fuse box.
- › Call the Kmart Customer Service Centre on 1800 124 125 (Australia).

Some minor faults can be fixed by referring to the instructions given in the Troubleshooting section below.

DESCRIPTION	INSPECTION ITEMS
No washing	<ul style="list-style-type: none"><li>› If the power is off or the fuse is burned out.</li><li>› If the power supply voltage is too low.</li><li>› If the water amount reaches to the required water level. (The washer will not work if the water amount does not reach the required water level)</li><li>› If it is set to "Delay" washing mode. (It will only start to work until the reservation time reached)</li></ul>
No water flows in	<ul style="list-style-type: none"><li>› If the power is off or the fuse is burned out.</li><li>› If the water supply is cut off or the water pressure too low.</li><li>› If the inlet hose is properly connected and the water tap is opened.</li><li>› If the filtering screen of inlet valve is blocked by dirt.</li><li>› If the coil of inlet valve is damaged. (The slight electromagnetic sound is normal phenomenon when the inlet valve is switched on)</li><li>› If the "Start / Pause" button is pressed after the power switch is pressed.</li></ul>
Abnormal draining	<ul style="list-style-type: none"><li>› If the water drain hose is placed very high.</li><li>› If the end of water drain hose is sealed in pond.</li><li>› If the internal rubber ring of drain valve is blocked by dirt.</li></ul>
Abnormal spin	<ul style="list-style-type: none"><li>› If the door lid is closed.</li><li>› If all clothing piled largely at one side of barrel or the clothing is excessively placed.</li><li>› If the washer is not placed in stable condition or it is placed in inclination state. (The ground is not flat).</li><li>› If the motor belt is loosened.</li></ul>

# Troubleshooting (Continued)

When the washing machine experiences a fault, please contact Kmart customer service support team on:

Telephone: 1800 124 125

**WARNING!** Never dismantle the washing machine.

## ERROR MESSAGES AND SOLUTIONS

INDICATION	REASON	SOLUTION
"E1" displays	Alarm for abnormal water intake.	Check the water tap is opened or not
"E2" displays	Alarm for water drain has not finished.	Check the water level sensor and drain pump
"E3" displays	Alarm for lid not closed before wash and spin.	Close the lid, Press "Start" button
"E4" displays	Alarm for washing stay at one side.	Manually balance clothes in the barrel by hand.
Other		If problems still occur, please contact the support team with the number at the top of this page.

# Technical Specifications

Below outlines the technical specifications for your Anko Washing Machine.

	<b>ATLW55G</b>	<b>ATLW80G</b>	<b>ATLW100G</b>
Size (mm)	515w × 525d × 910h	580w × 596d × 965h	601w × 630d × 1000h
Net Weight	31kg	39kg	45kg
Rated Input Power	400W	480W	600W
Rated Capacity of Wash and Spin	5.5kg (dry clothes)	8.0kg (dry clothes)	10.0kg (dry clothes)
Rated Voltage	230-240V~	230-240V~	230-240V~
Rated Frequency	50Hz	50Hz	50Hz
Maximum water pressure permitted in the water inlet	0.03MPa	0.03MPa	0.03MPa
Minimum water pressure permitted in the water inlet	0.8MPa	0.8MPa	0.8MPa

## **NOTE:**

This product is subject to continuous improvement, specification are subject to change without prior notice.

Energy efficiency test program: This product was tested in accordance with AS/NZS 2040.2 and AS/NZS6400 using the below program.

### **ATLW55G:**

During "Normal" Washing program, water level is 6 level, wash Temp. is warm.

### **ATLW80G**

During "Normal" Washing program, water level is 7 level, wash Temp. is warm, rinse time is 1.

### **ATLW100G**

During "Normal" Washing program, water level is 8 level, wash Temp. is warm.

This page is intentionally left blank

# Warranty

## 24 Month Warranty

Thank you for your purchase from Kmart.

Kmart Australia Ltd warrants your new product to be free from defects in materials and workmanship for the period stated above, from the date of purchase, provided that the product is used in accordance with accompanying recommendations or instructions where provided. This warranty is in addition to your rights under the Australian Consumer Law.

Kmart will provide you with your choice of a refund, repair or exchange (where possible) for this product if it becomes defective within the warranty period. Kmart will bear the reasonable expense of claiming the warranty. This warranty will no longer apply where the defect is a result of alteration, accident, misuse, abuse or neglect.

Please retain your receipt as proof of purchase and contact our Customer Service Centre on 1800 124 125 (Australia) or alternatively, via Customer Help at [Kmart.com.au](http://Kmart.com.au) for any difficulties with your product.

Warranty claims and claims for expense incurred in returning this product can be addressed to our Customer Service Centre at 690 Springvale Rd, Mulgrave Vic 3170.

Our goods come with guarantees that cannot be excluded under the Australian Consumer Law. You are entitled to a replacement or refund for a major failure and compensation for any other reasonably foreseeable loss or damage. You are also entitled to have the goods repaired or replaced if the goods fail to be of acceptable quality and the failure does not amount to a major failure.



This page is intentionally left blank

Model no: ATLW55G, ATLW80G & ATLW100G