

Assembly Instructions









43340842 7 DRAWER CHEST







ATTENTION:

DO NOT TIGHTEN THE SCREWS UNTIL THE PRODUCT IS FULLY ASSEMBLED.
FOR INDOOR USE ONLY.

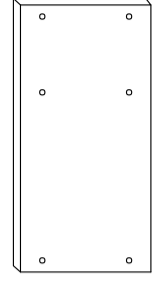
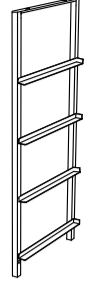
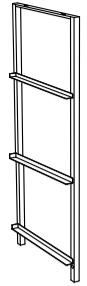
MAXIMUM TOTAL LOADING WEIGHT: 23KG. 10KG FOR THE TOP SHELF, 3KG FOR EACH LARGE DRAWER AND 1.5KG FOR EACH SMALL DRAWER.

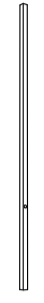
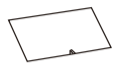
Hardware list

	(A)	4PCS		(E)	2PCS
	(B)	6 PCS		(F)	2PCS
	(C)	6 PCS		(G)	2PCS
	(D)	1PC		(H)	2PCS

	(1)	1PC		(2)	1PC		(3)	1PC
	(4)	1PC		(5)	2PCS		(6)	3PCS
							(7)	3PCS
							(8)	4PCS
							(9)	4PCS

STEP 1

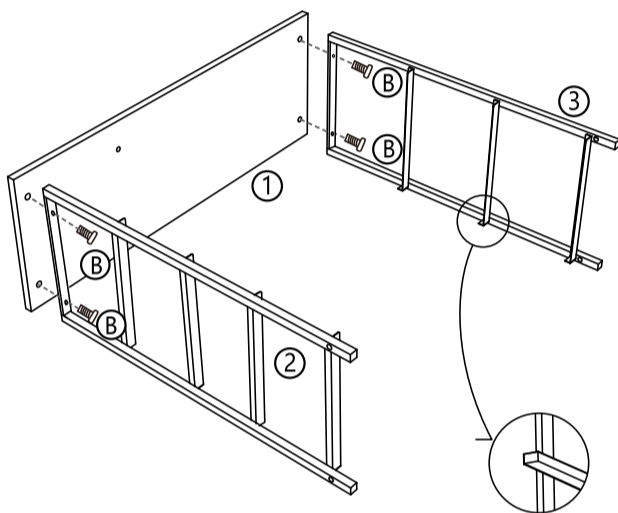

 (B) 4pcs

STEP 2

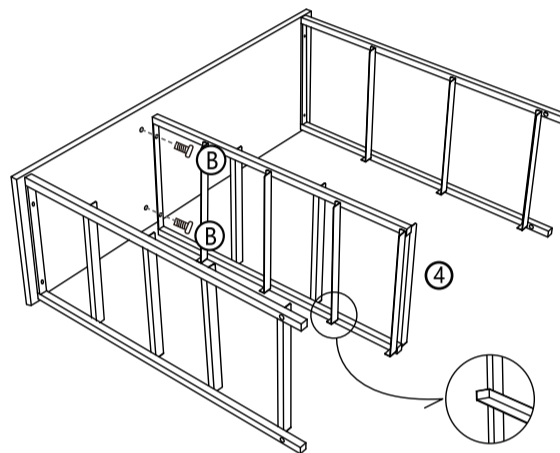

 (B) 2pcs

STEP 3

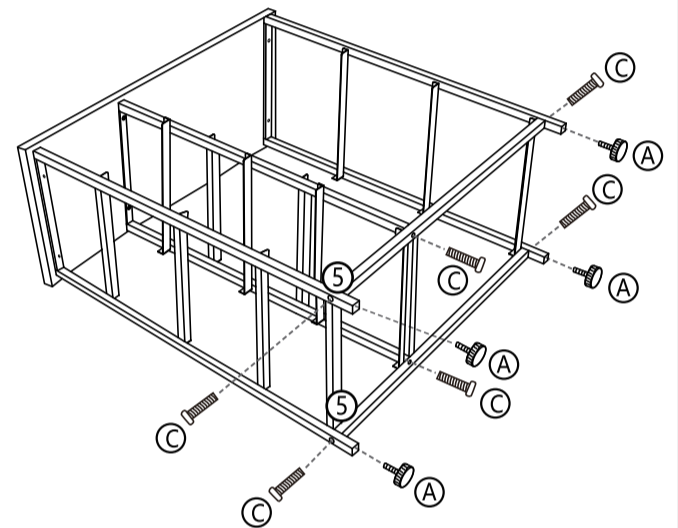

 (A) 4pcs  (C) 6pcs

STEP 4

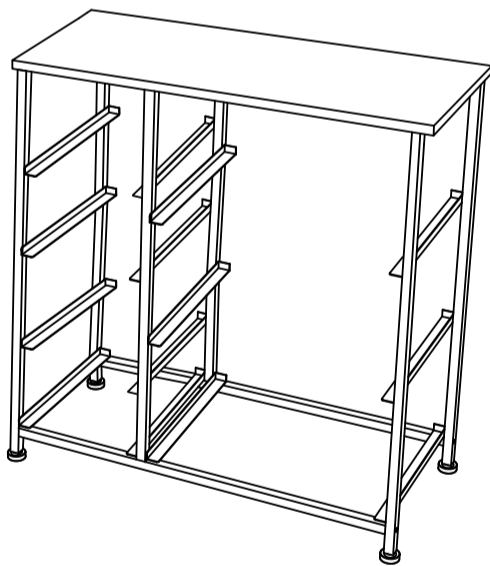

STEP 5

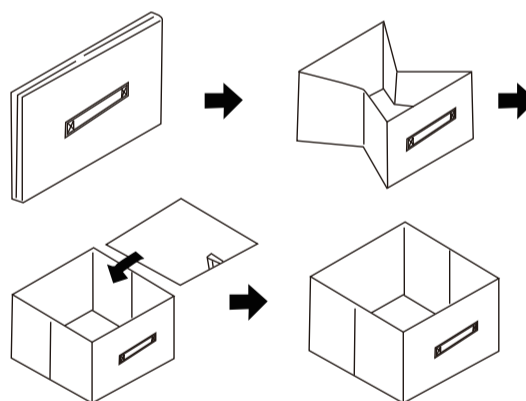

 (6) 3pcs  (7) 3pcs  (8) 4pcs  (9) 4pcs

STEP 6

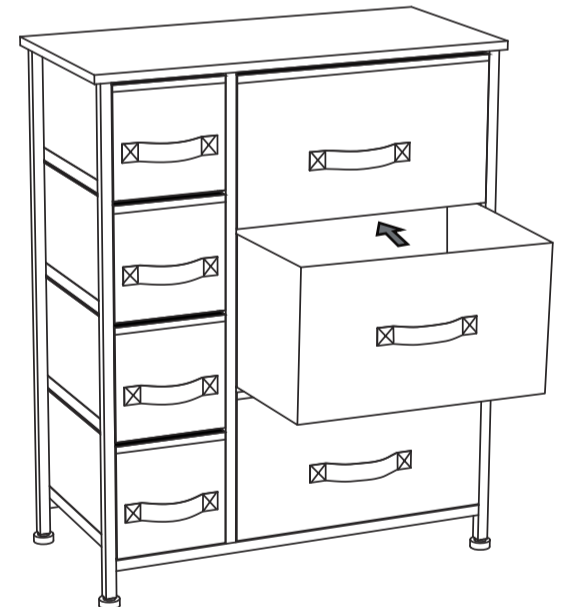

STEP 7

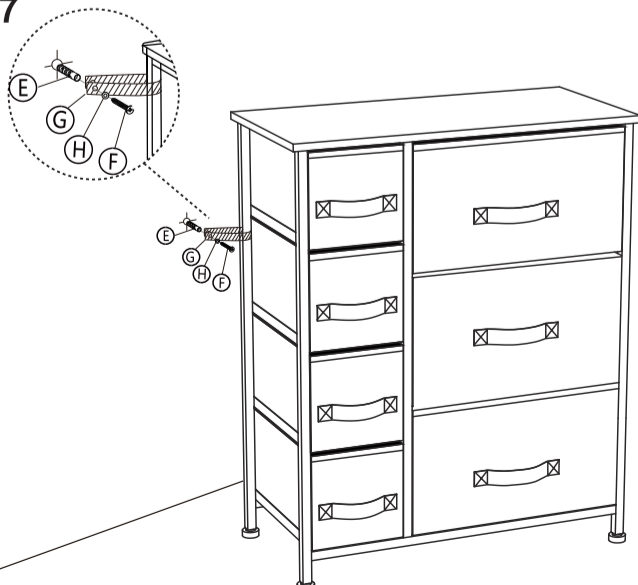

It is strongly recommended that this product is permanently fixed to the wall. Please seek professional advice if you are in doubt of what fixing device to use. Regularly check that anchors are securely maintained.

Check any electrical wires or plumbing inside the wall before drilling any holes (if you are unsure please seek professional advice from a qualified tradesperson).

 (E) 2pcs  (F) 2pcs  (G) 2pcs  (H) 2pcs