

# CONSTRUCTION:

BLOCKS

## Instructions ENCLOSURE SERIES REPTILE ENCLOSURE



6+  
YEARS

47  
PIECES

ADULT ASSISTANCE IS RECOMMENDED.

**WARNING:**  
CHOKING HAZARD - Small parts  
Not for children under 3 years.

Difficulty  
★☆☆☆☆

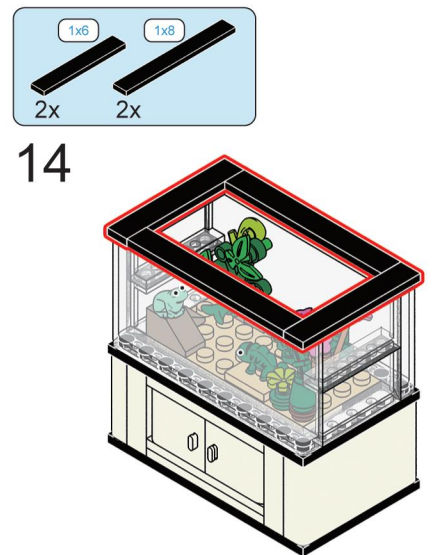
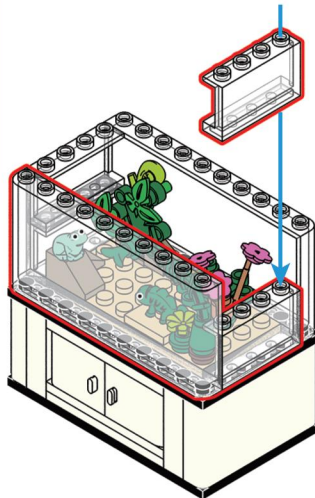
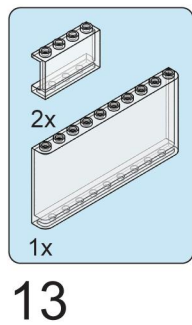
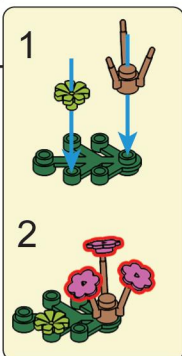
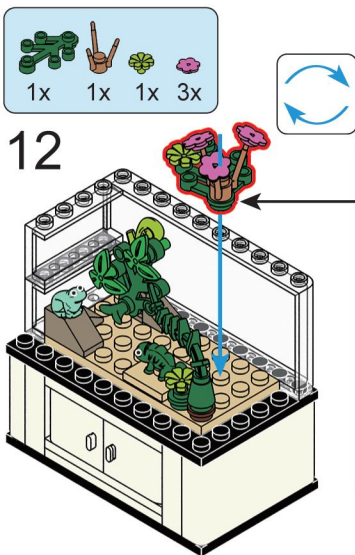
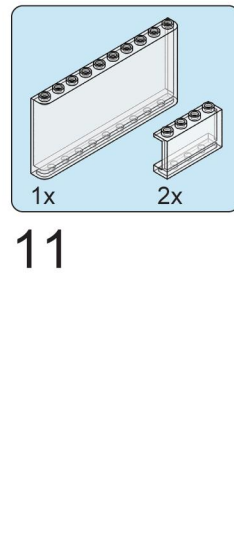
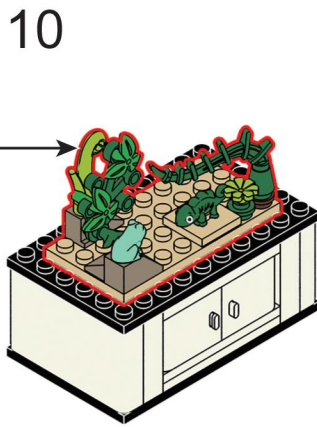
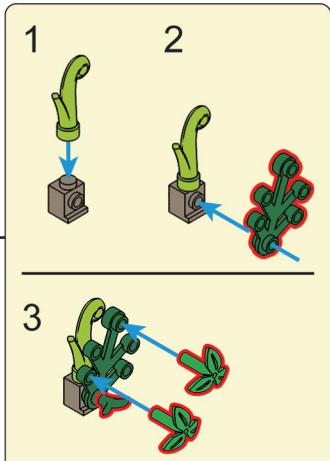
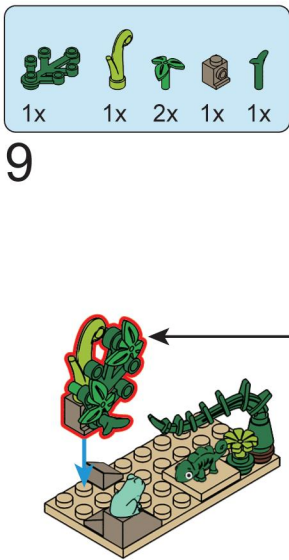
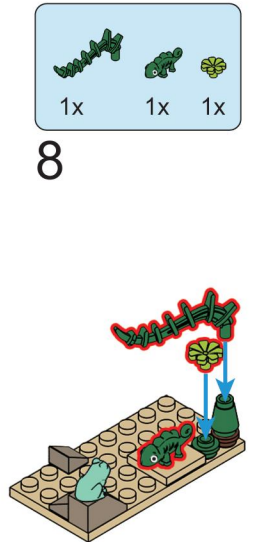
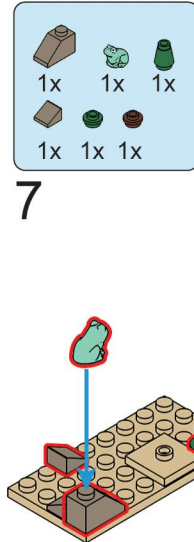
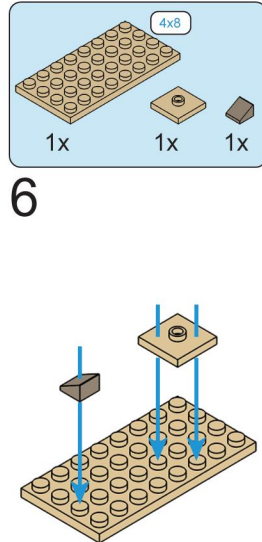
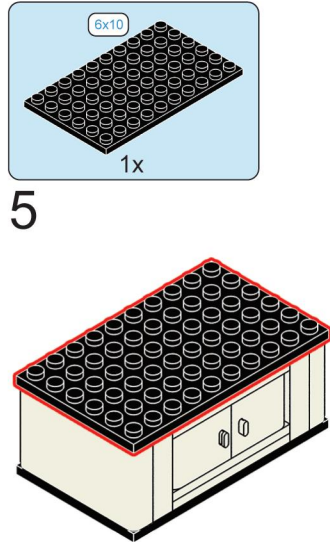
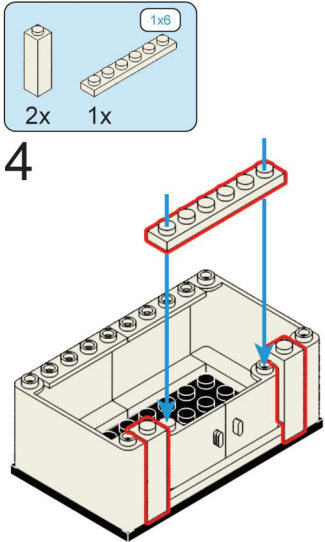
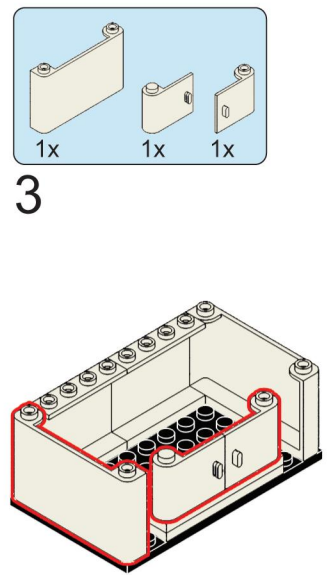
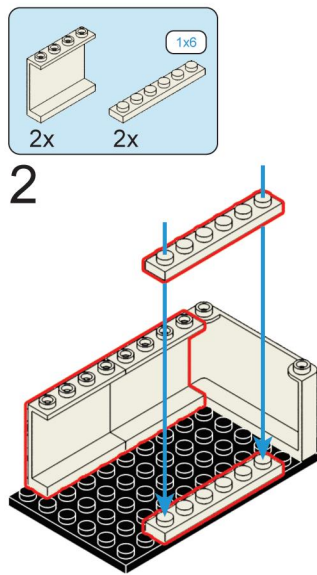
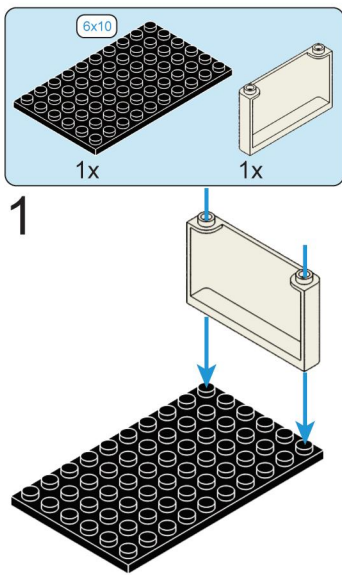

# CONSTRUCTION:

BLOCKS

## Instructions ENCLOSURE SERIES TURTLE ENCLOSURE

6+  
YEARS

47  
PIECES



ADULT ASSISTANCE IS RECOMMENDED.

**WARNING:**  
CHOKING HAZARD - Small parts  
Not for children under 3 years.

Difficulty  
★☆☆☆☆

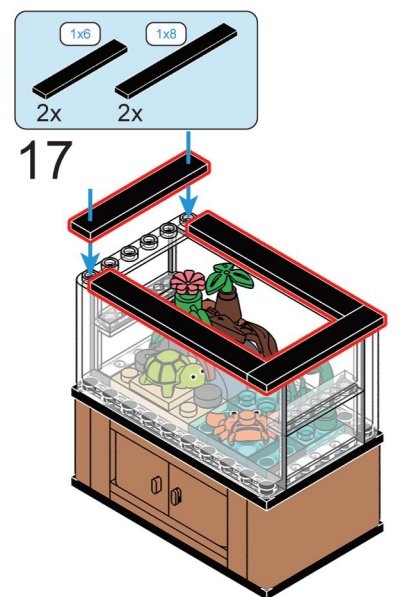
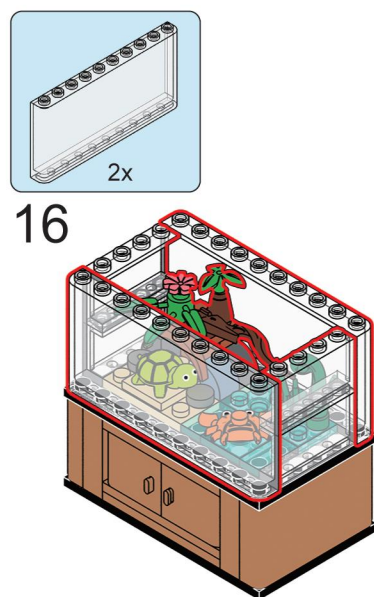
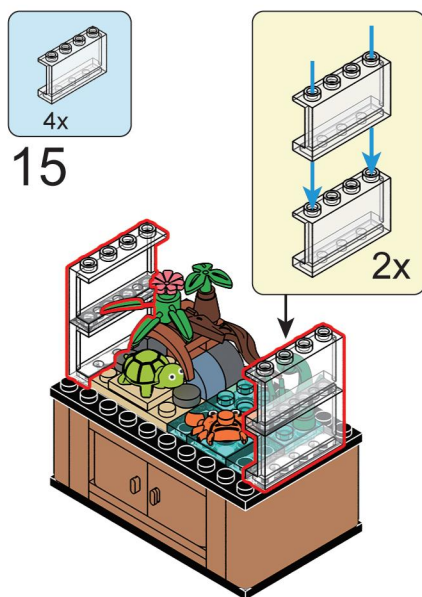
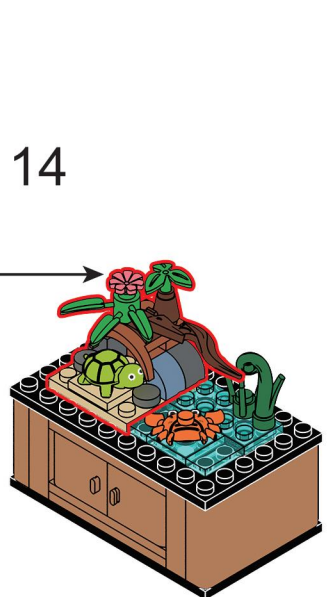
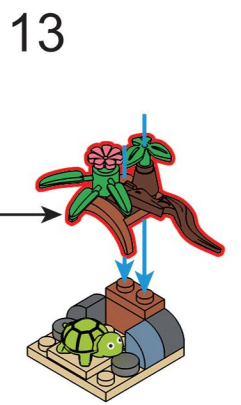
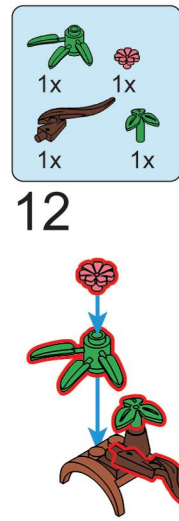
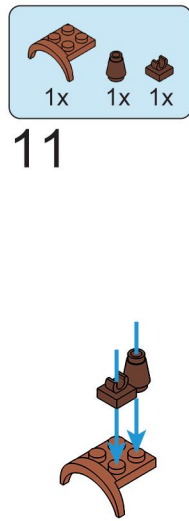
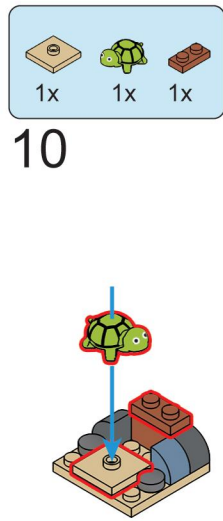
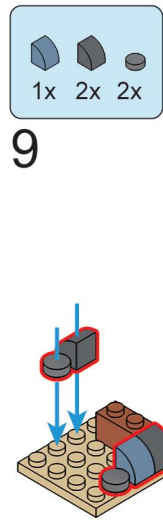
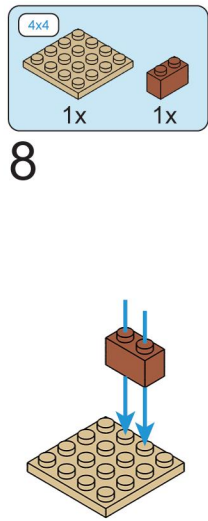
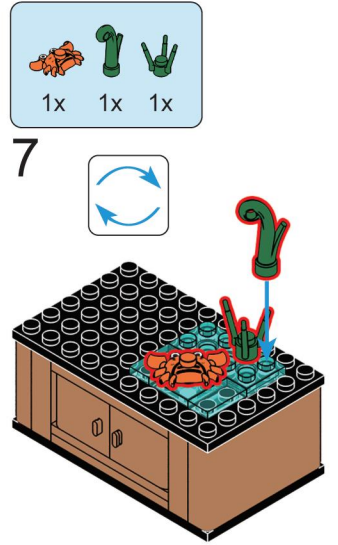
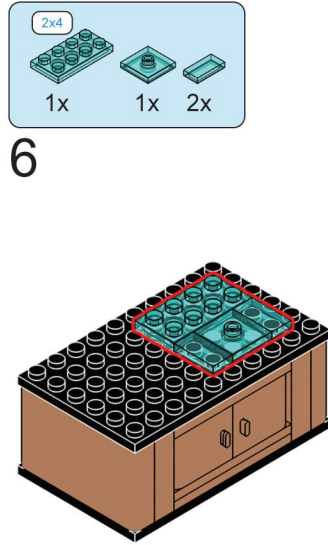
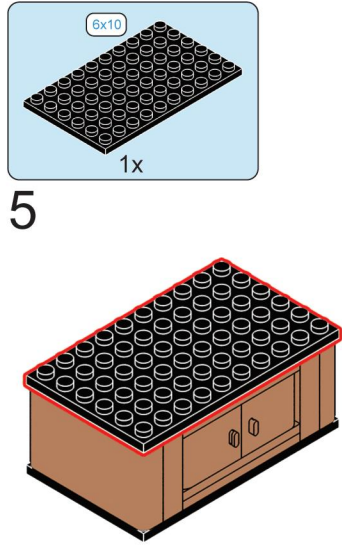
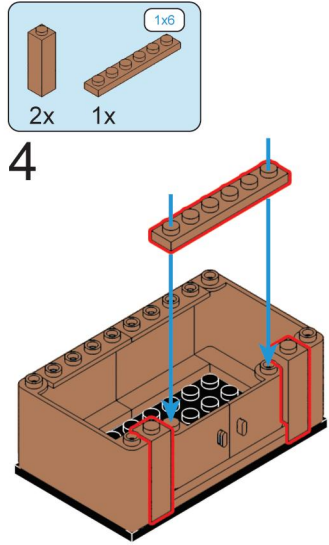
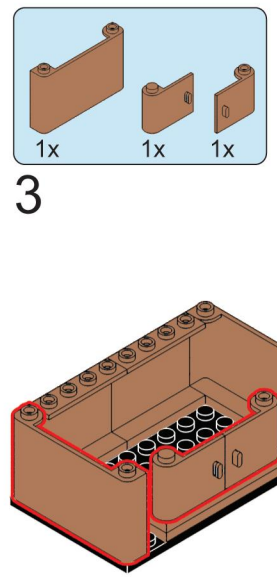
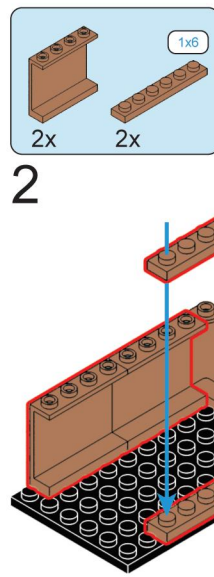
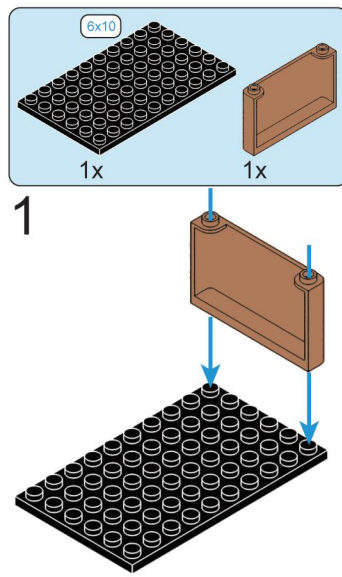

# CONSTRUCTION:

BLOCKS

## Instructions ENCLOSURE SERIES FISH ENCLOSURE

6+  
YEARS

42  
PIECES



ADULT ASSISTANCE IS RECOMMENDED.

**WARNING:**  
CHOKING HAZARD - Small parts  
Not for children under 3 years.

Difficulty

