

Assembly Instructions





43361793 3 TIER AIRER

CARE INSTRUCTION: WIPE CLEAN WITH A SOFT DRY OR DAMP CLOTH. KEEP AWAY FROM WATER AND DIRECT SUNLIGHT. FOR INDOOR AND DOMESTIC USE. CHECK AND TIGHTEN ALL PARTS REGULARLY.

WARNING: DO NOT STAND ON THE UNIT. DO NOT LEAN ON THE PRODUCT. DO NOT USE UNTIL ALL SCREWS, BOLTS AND KNOBS ARE FIRMLY SECURED. THIS PRODUCT CONTAINS SMALL PARTS AND SHARP POINTS, KEEP AWAY FROM CHILDREN AND BABIES. ADULT ASSEMBLY REQUIRED. FAILURE TO FOLLOW THESE WARNINGS COULD RESULT IN SERIOUS INJURY.

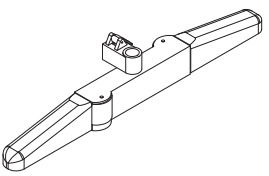
MAXIMUM TOTAL LOADING WEIGHT: TOP BAR 3KG, EACH SHELF 2.5KG, EACH HANGER 1KG, 20KGS IN TOTAL.

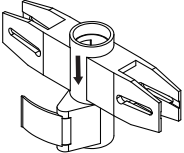
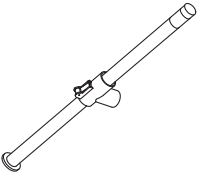
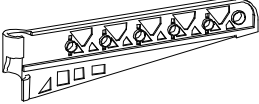
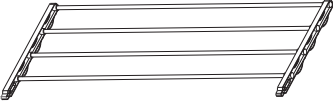
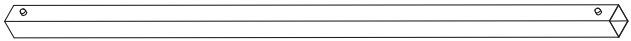
Hardware list

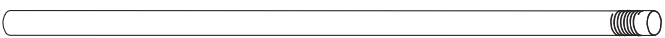
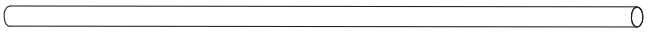
							
A	2PCS	B	6PCS	C	6PCS	D	2PCS
							
E	2PCS	F	6PCS				
		G	1PC				
		H	2PCS				
		I	2PCS				
		J	1PC				

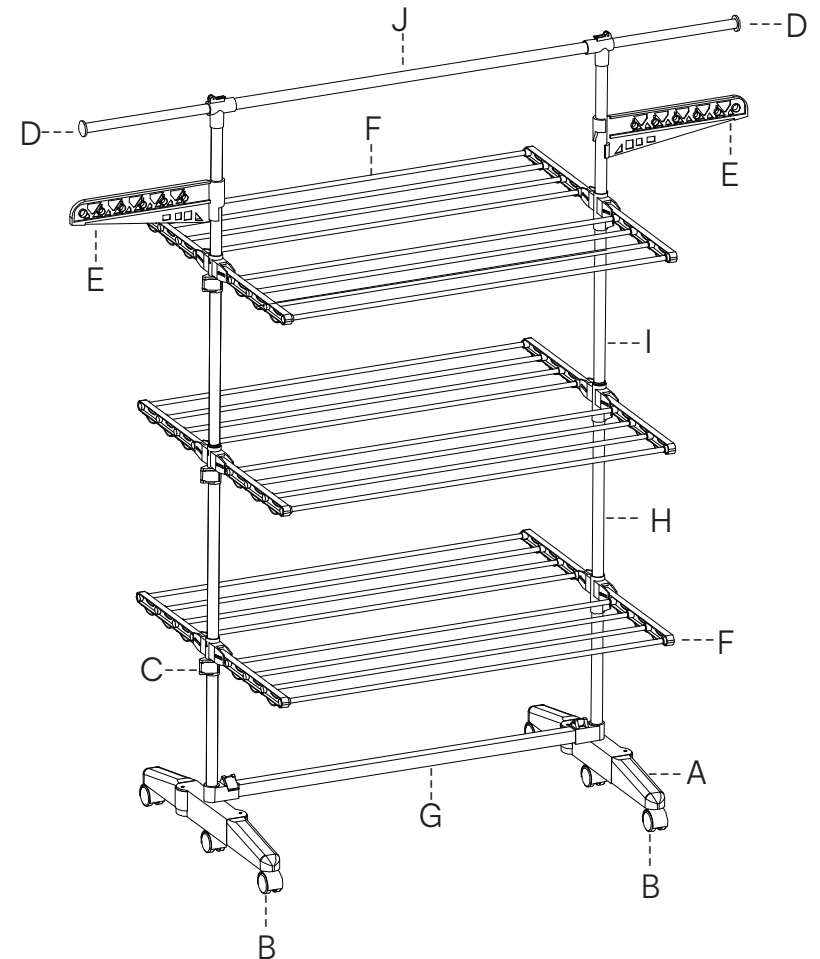

STEP 1

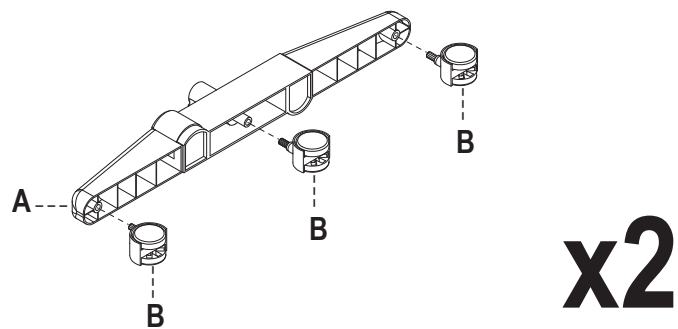

STEP 2

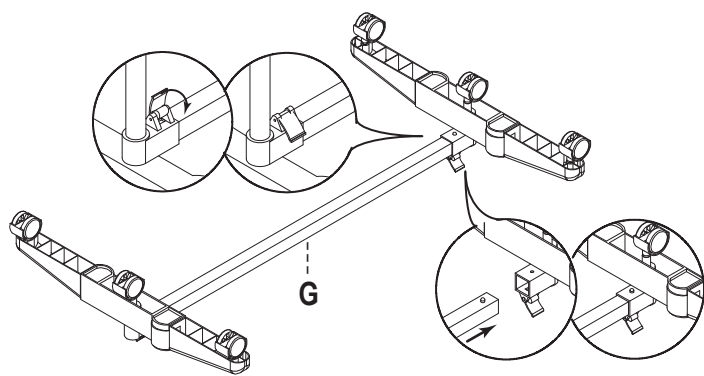

STEP 3

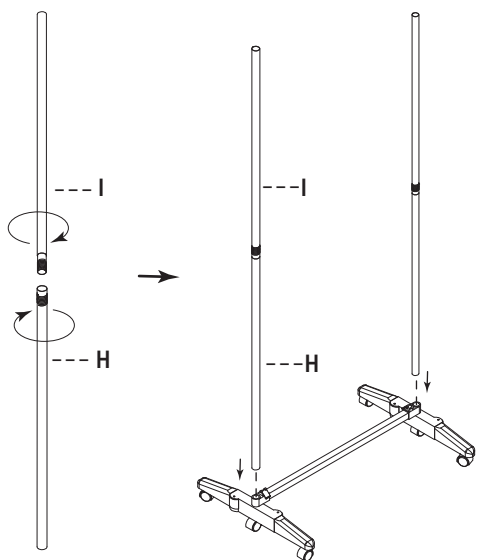

STEP 4

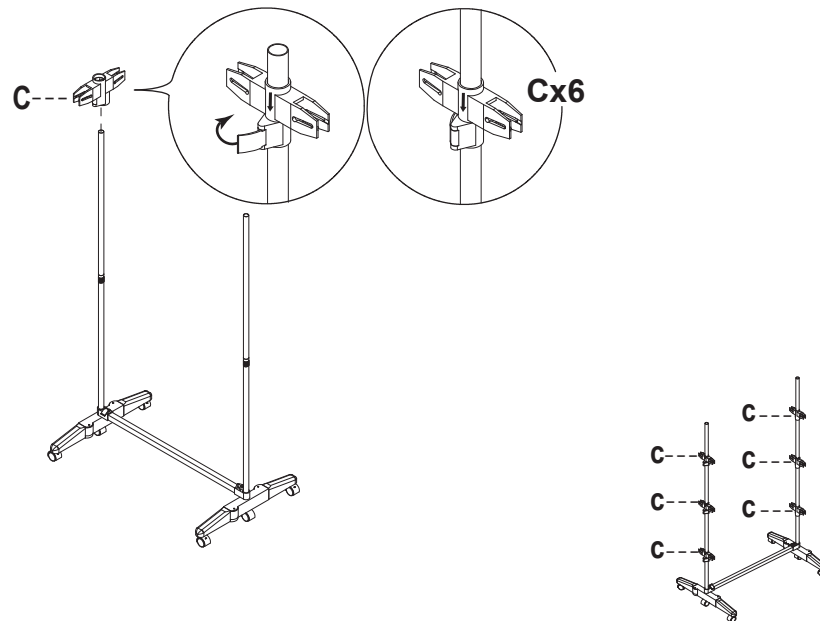

STEP 5

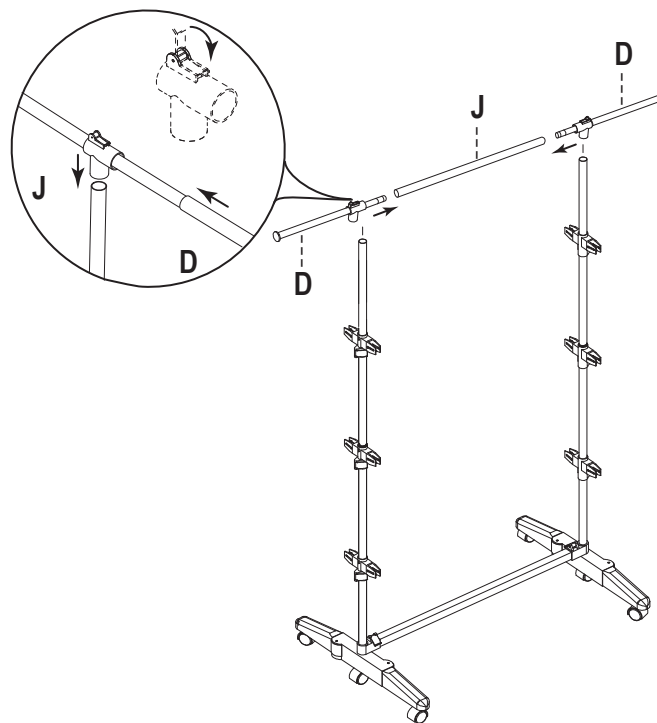

STEP 6

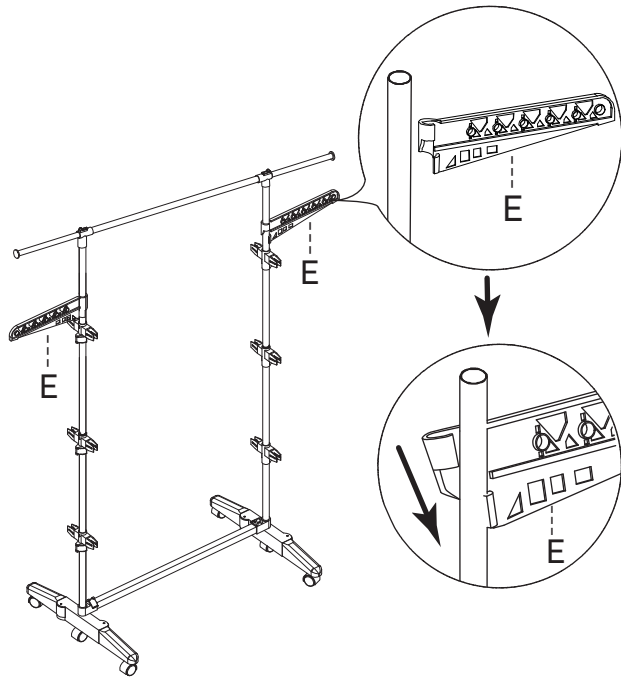

STEP 7

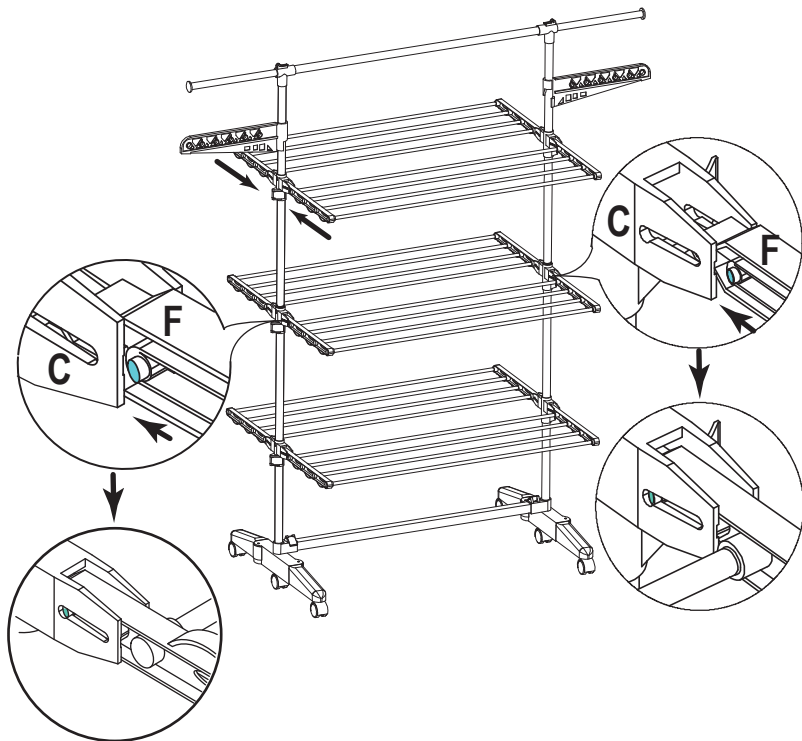

STEP 8

