

miniblocks

Eiffel Tower Instructions

12+
years

Building
Series

2600
PIECES

Difficulty Level



K: 43467105 | T: 70385526

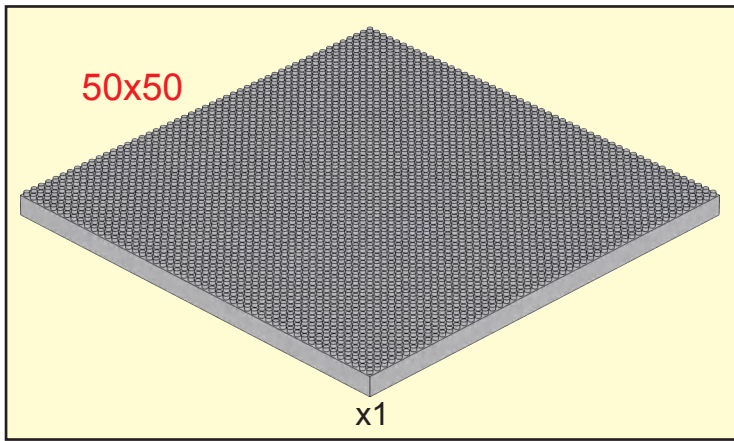

1

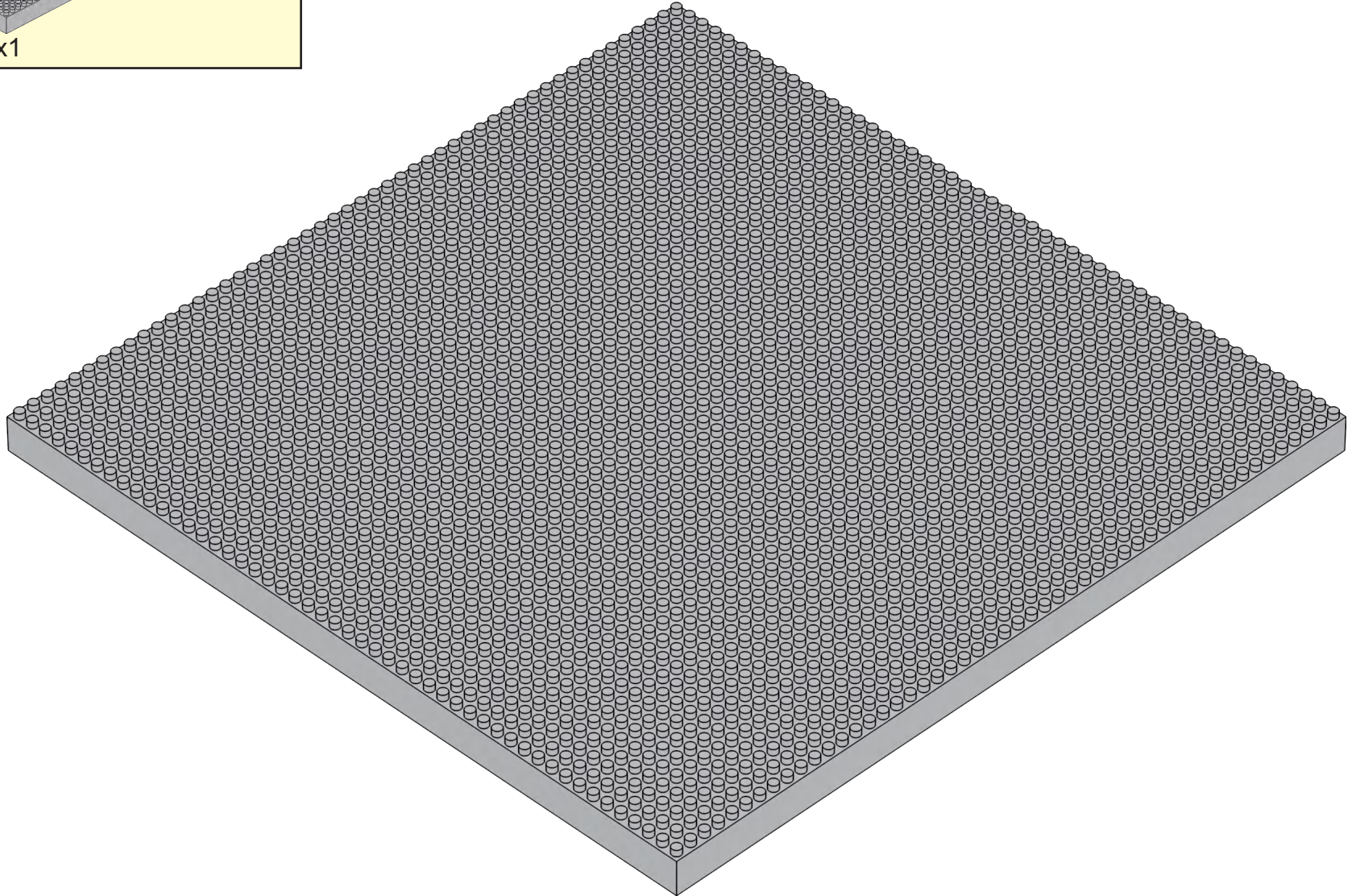

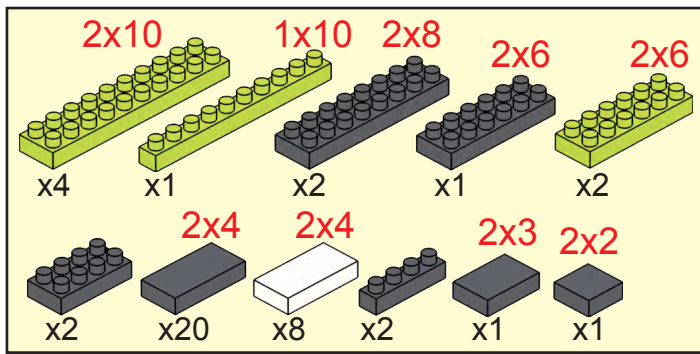

2

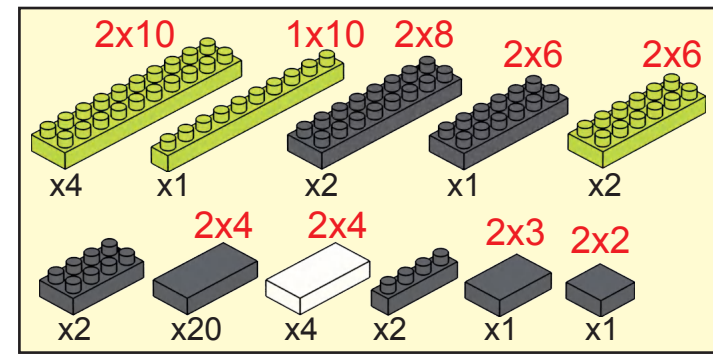
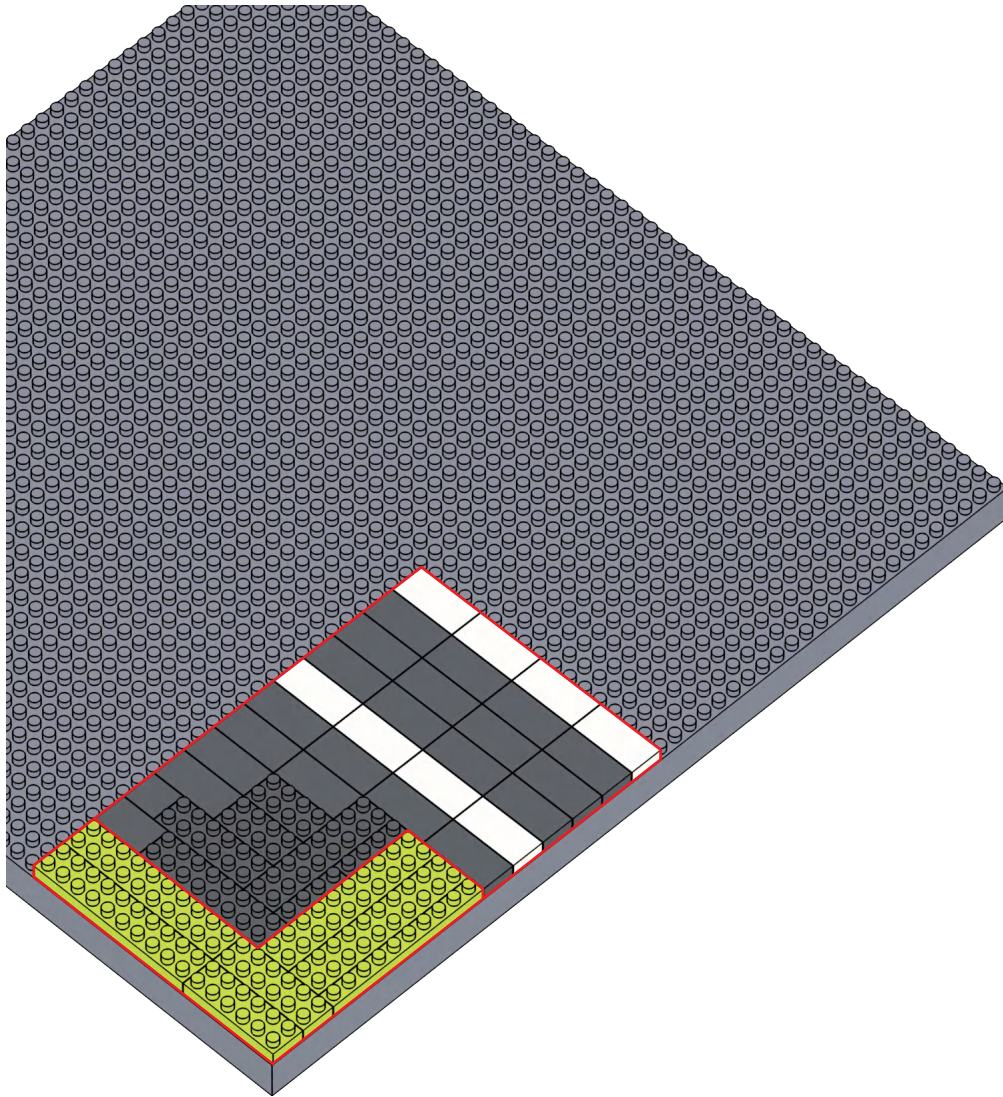

3

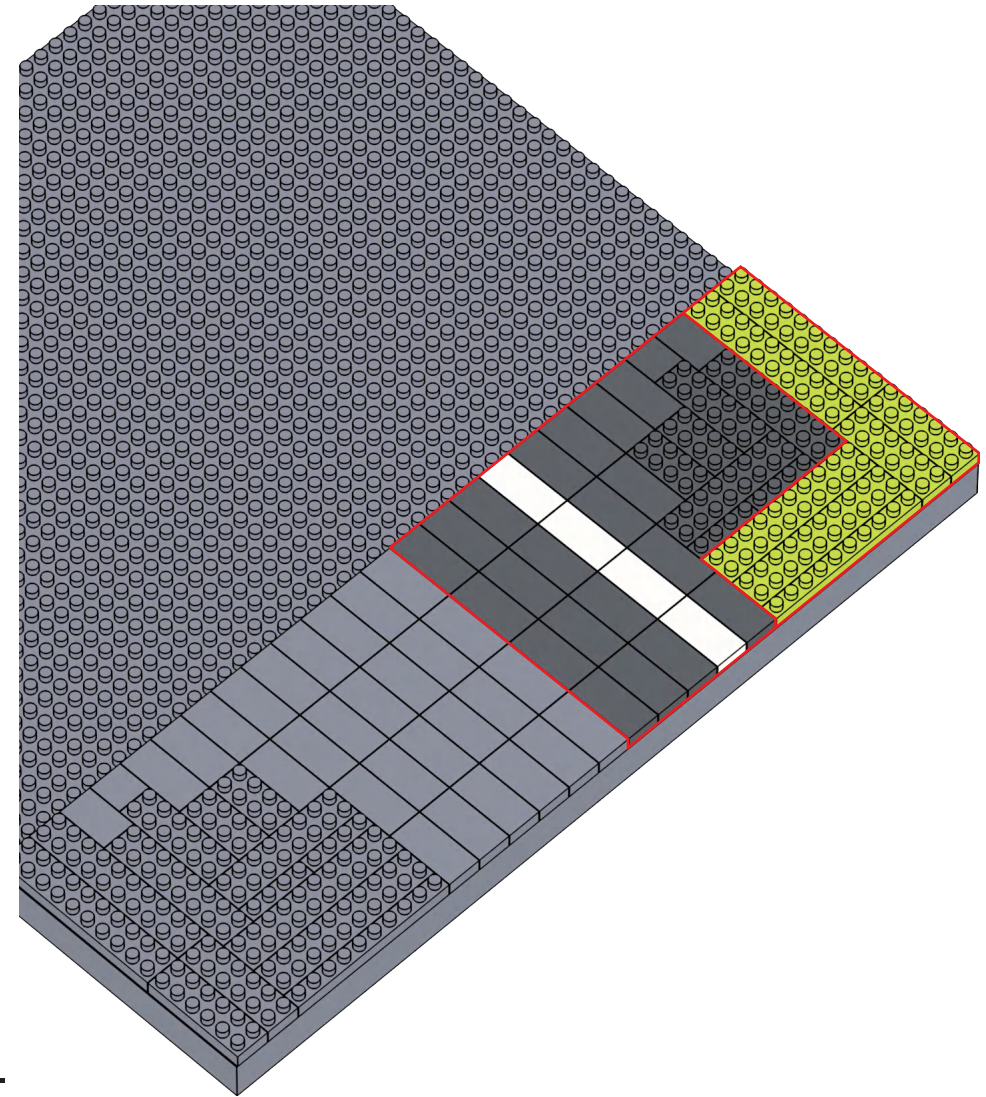

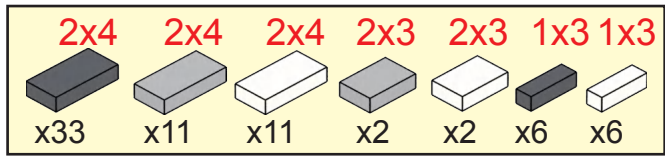

4

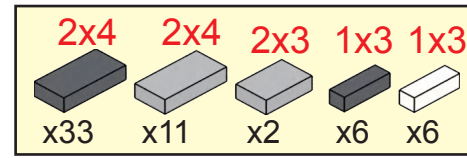
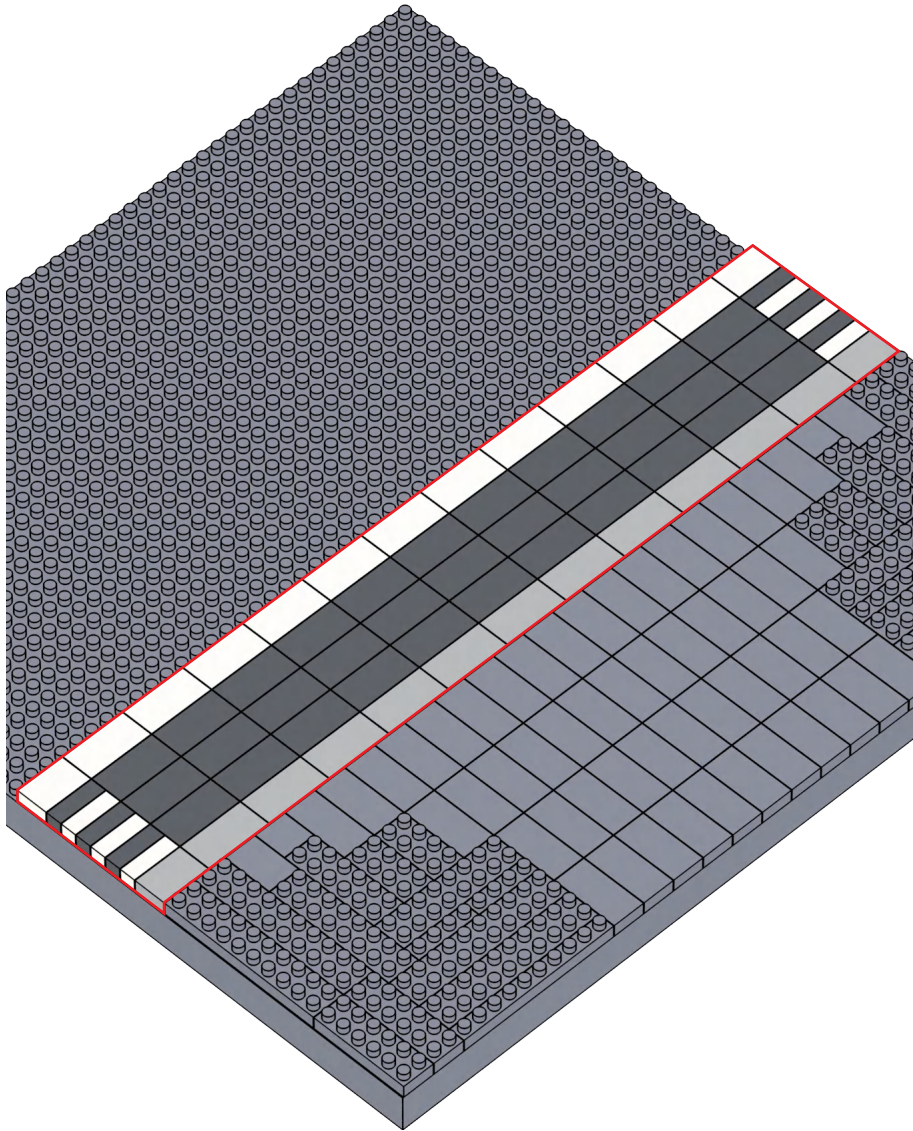

5

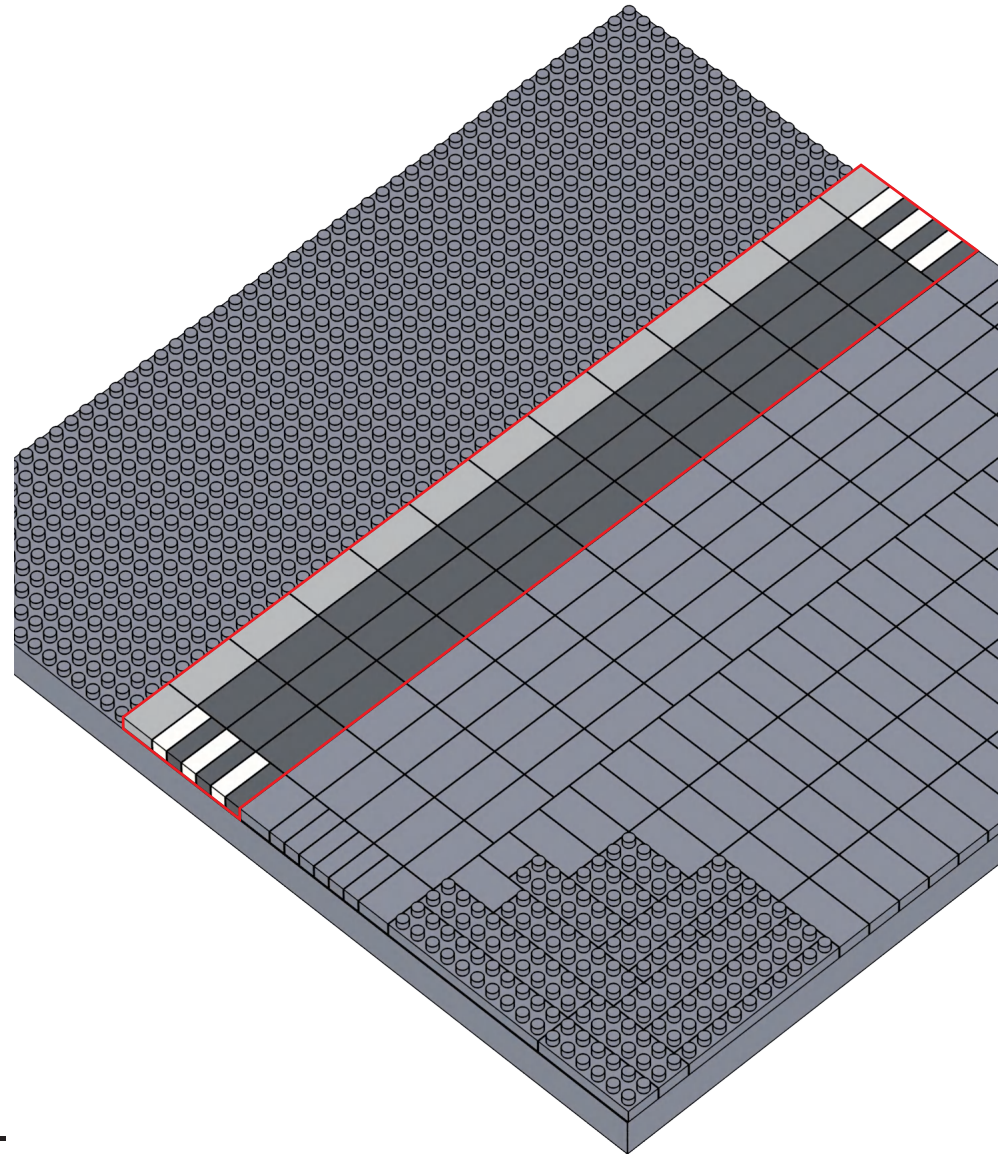

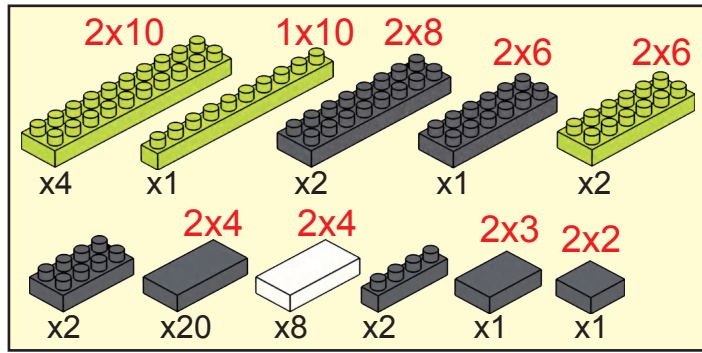

6

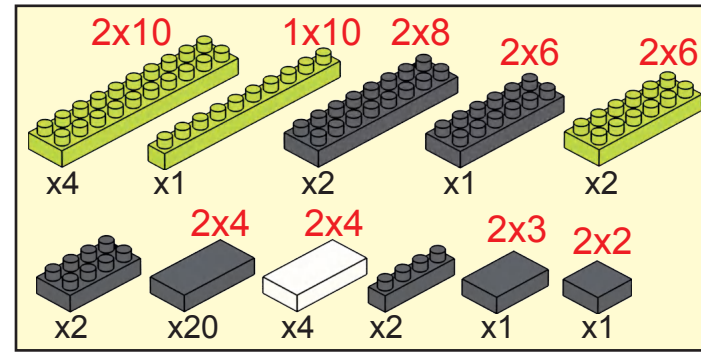
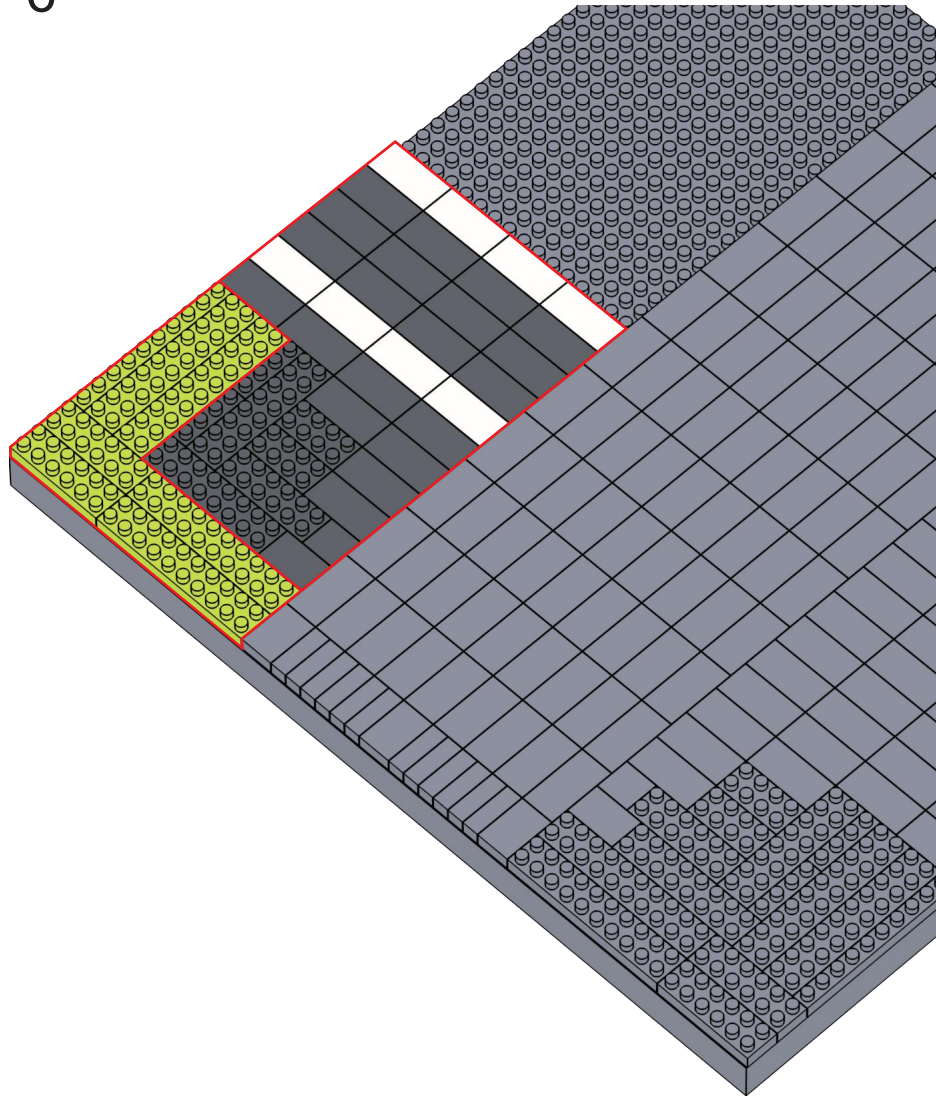

7

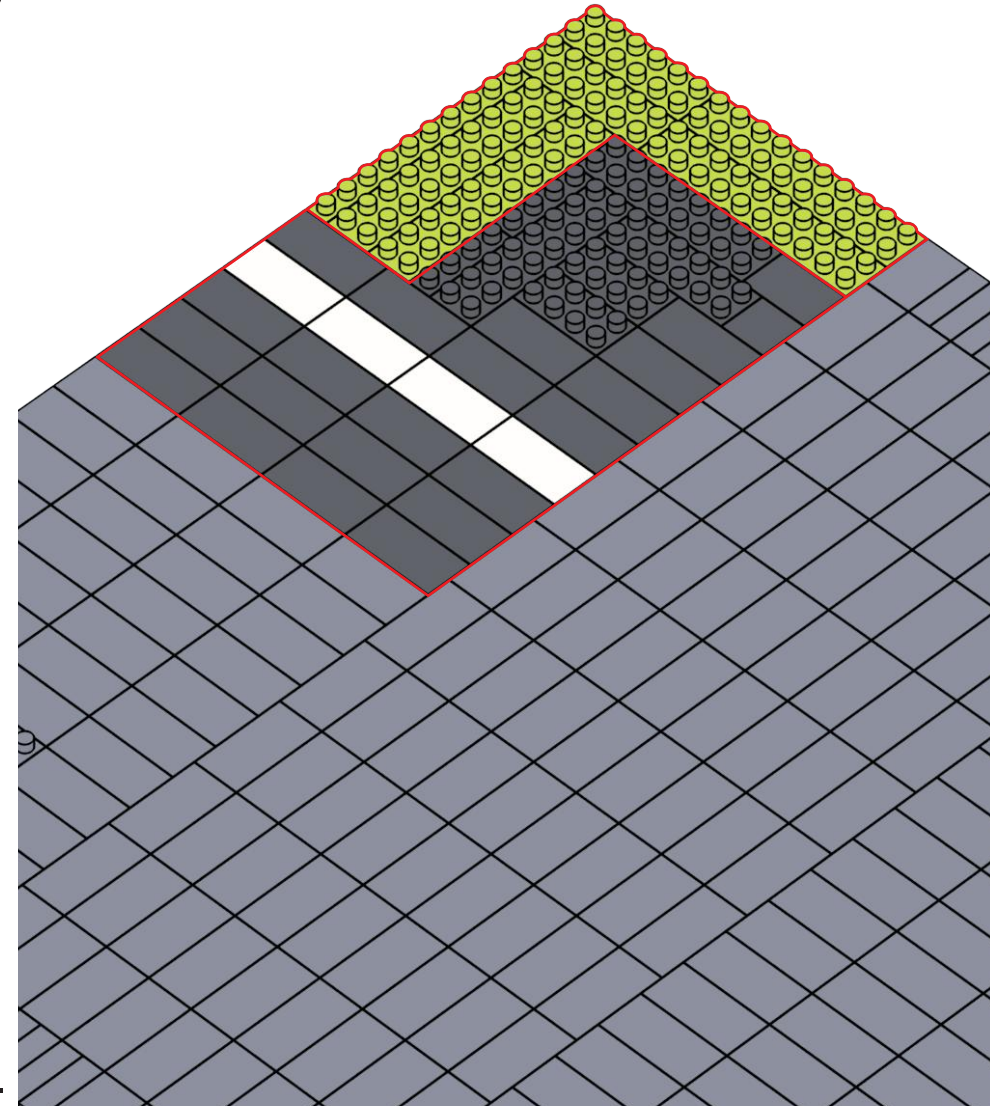

*   are transparent building blocks

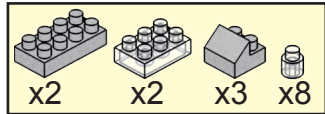

8

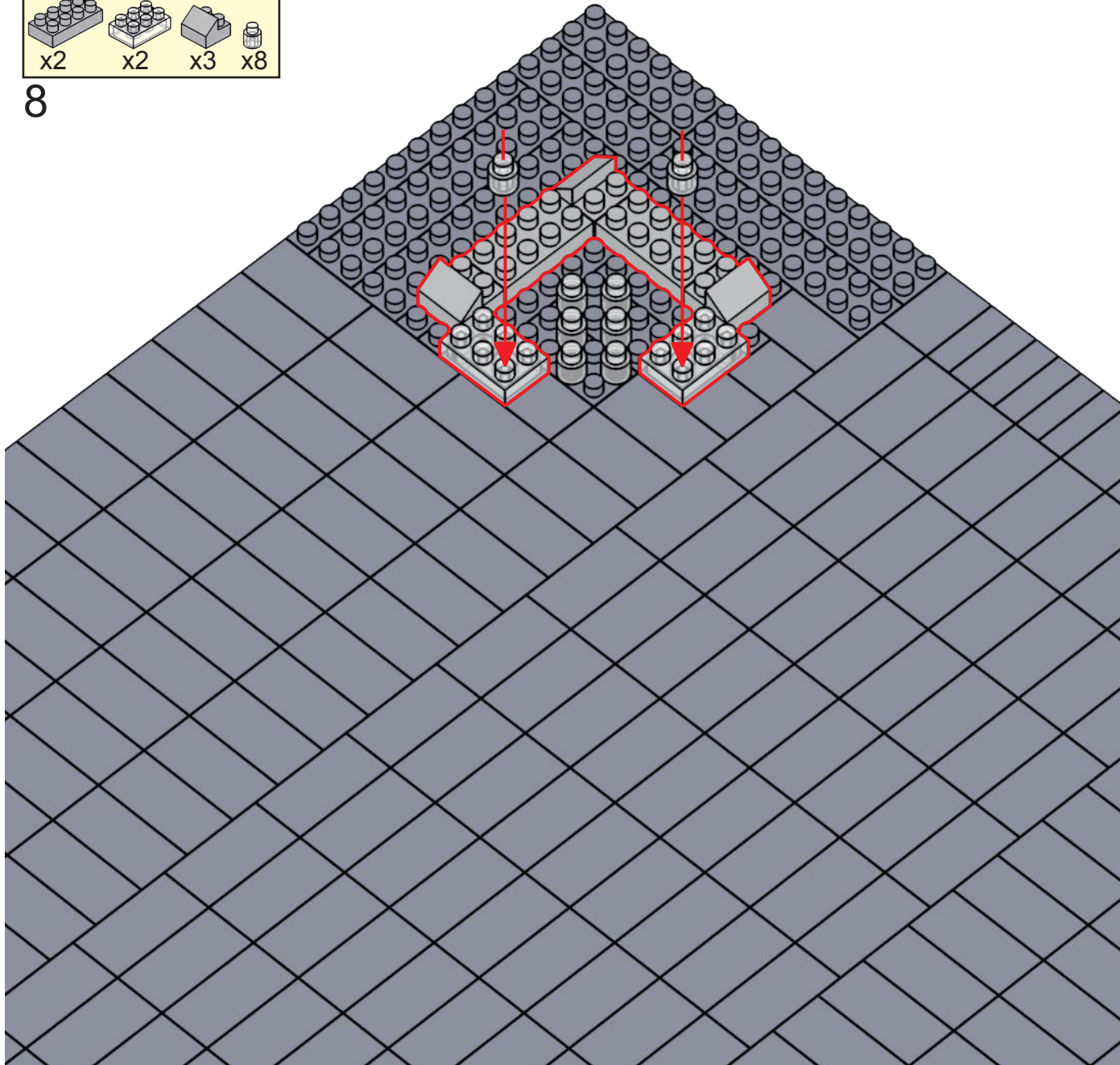

*  are transparent building blocks

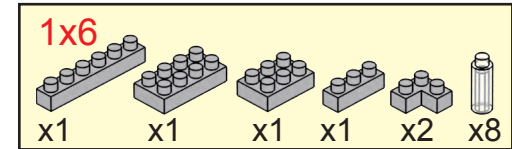

9

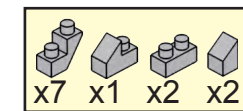
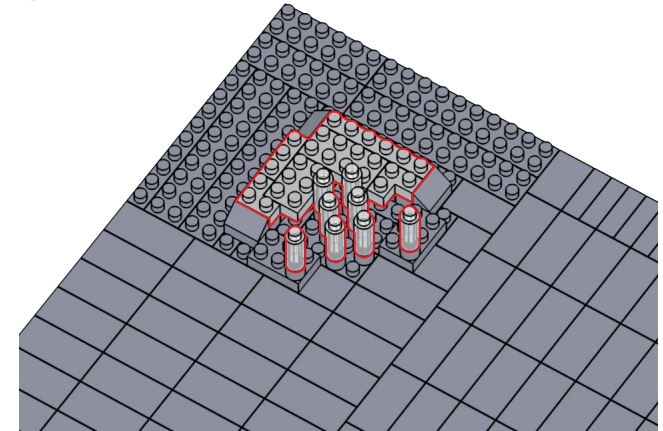

10

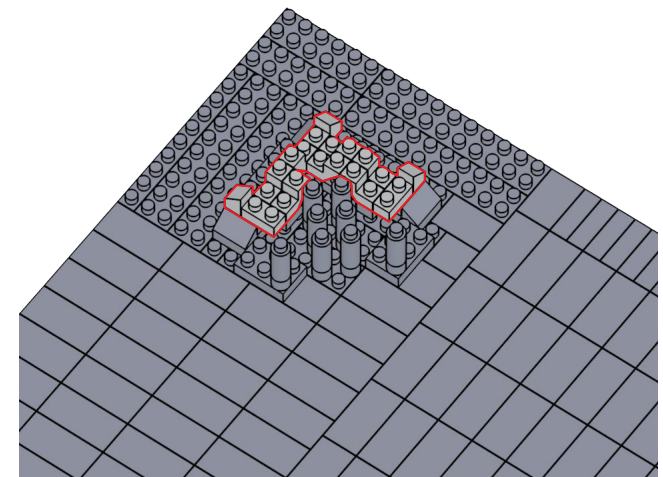

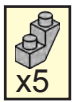

x5

11

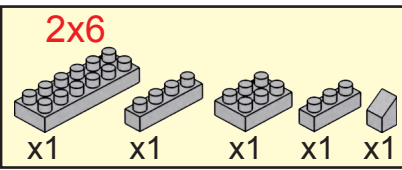
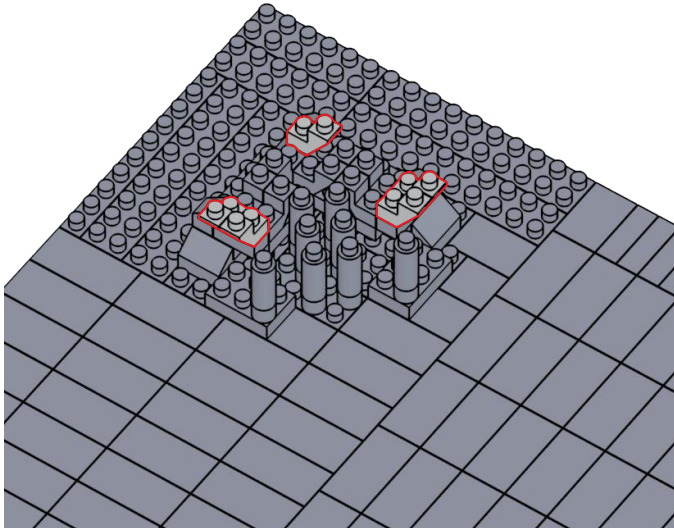

12

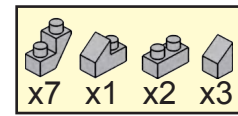
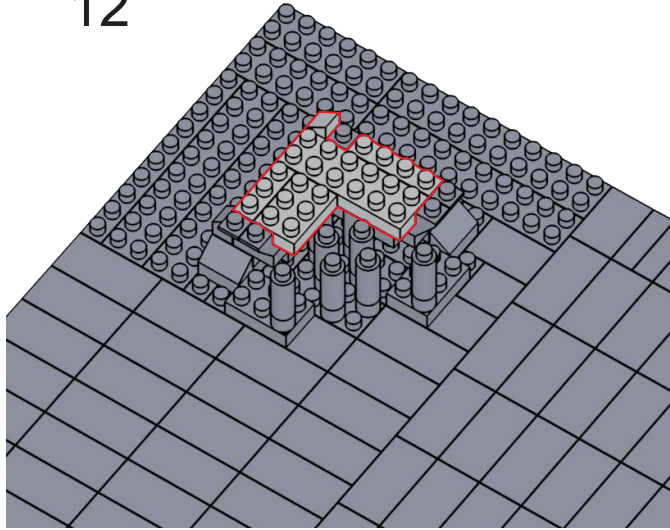

13

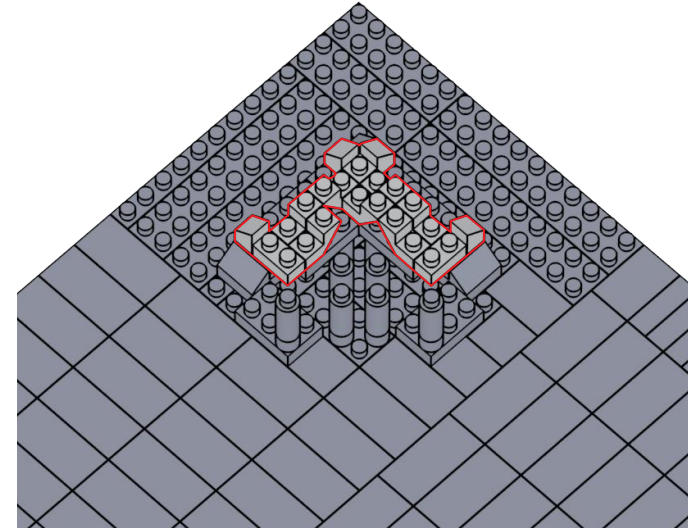

*  are transparent building blocks

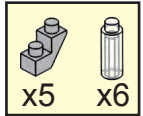

14

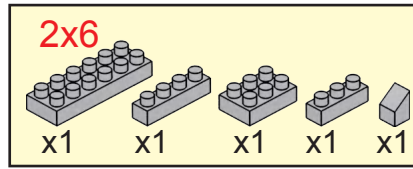
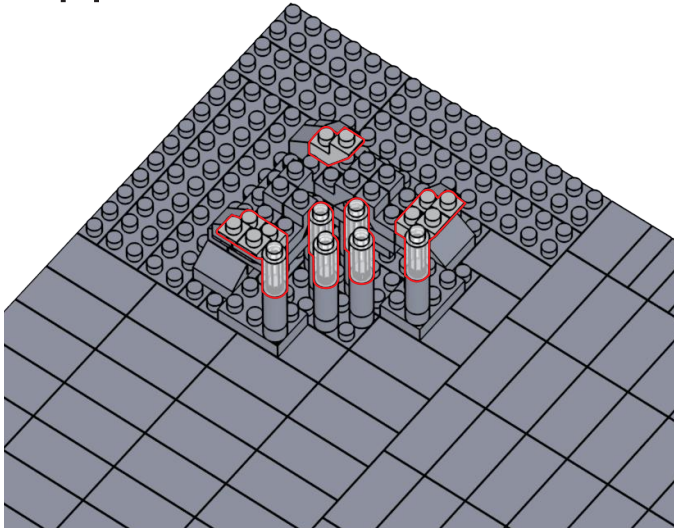

15

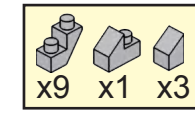
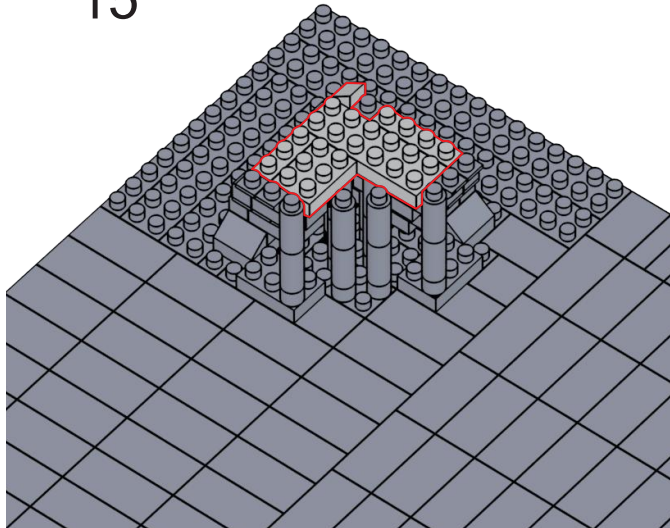

16

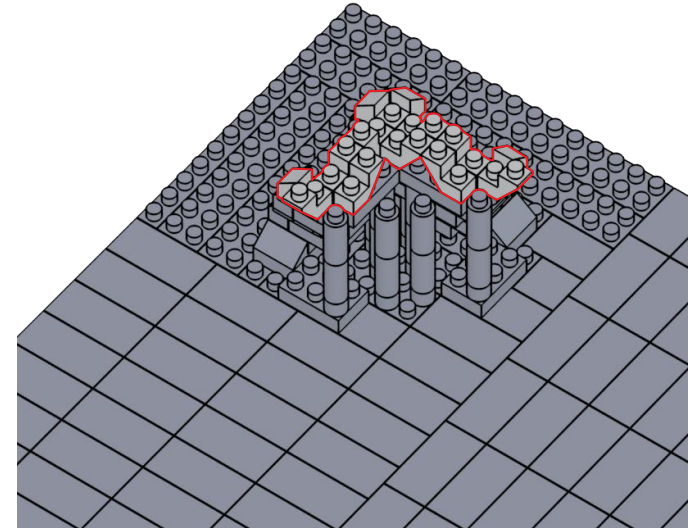

*  are transparent building blocks

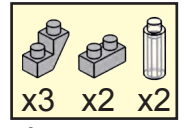

17

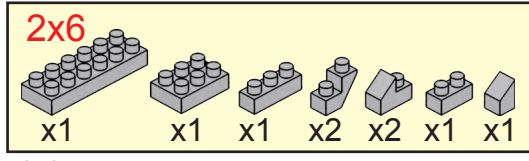
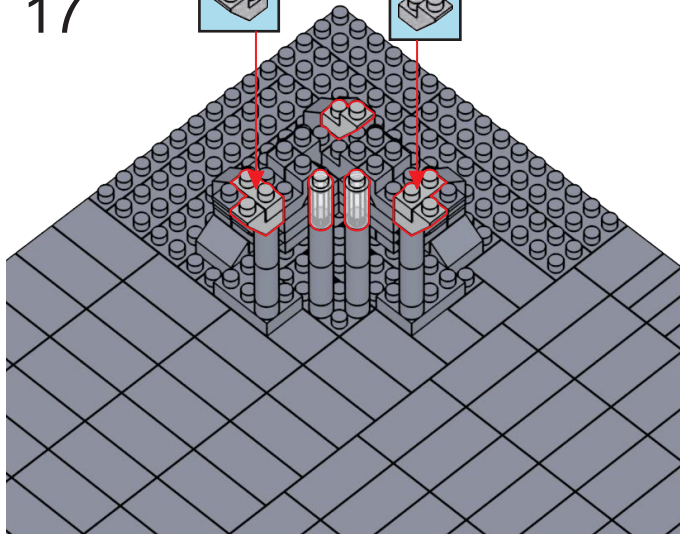
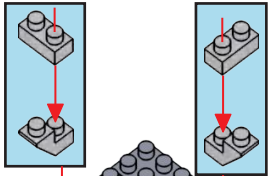

18

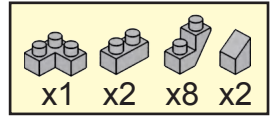
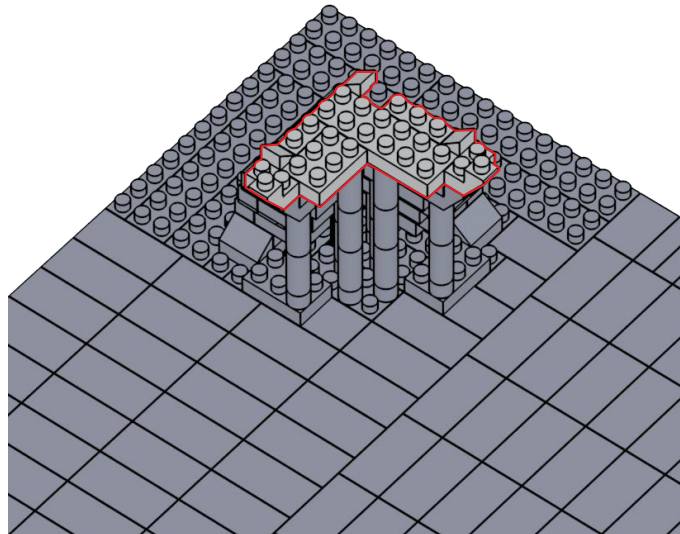

19

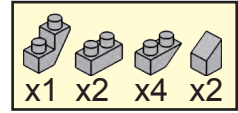
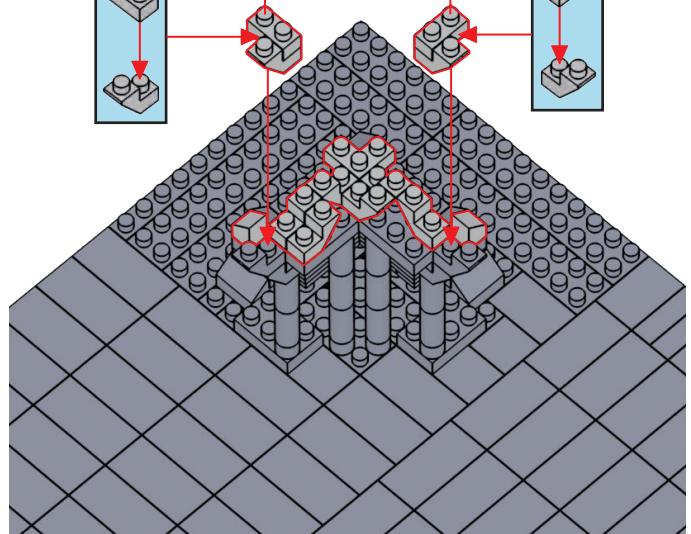
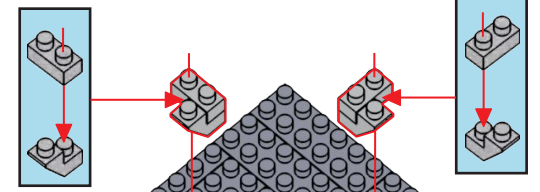

20

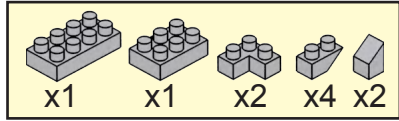
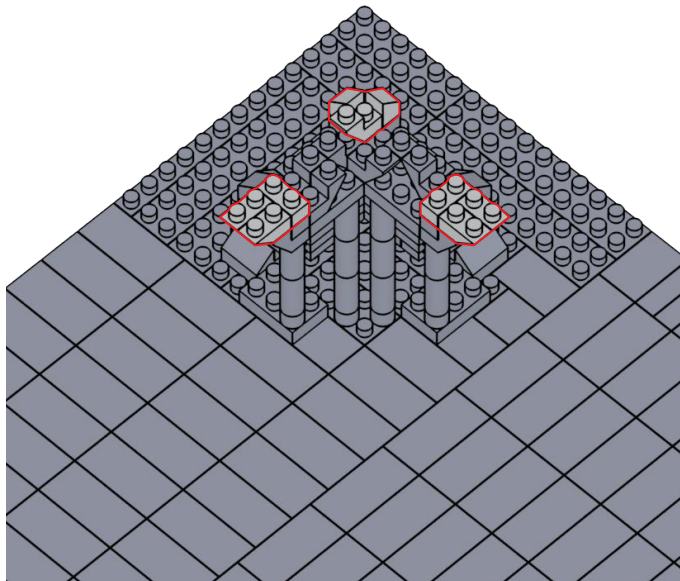

21

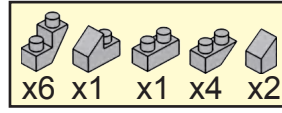
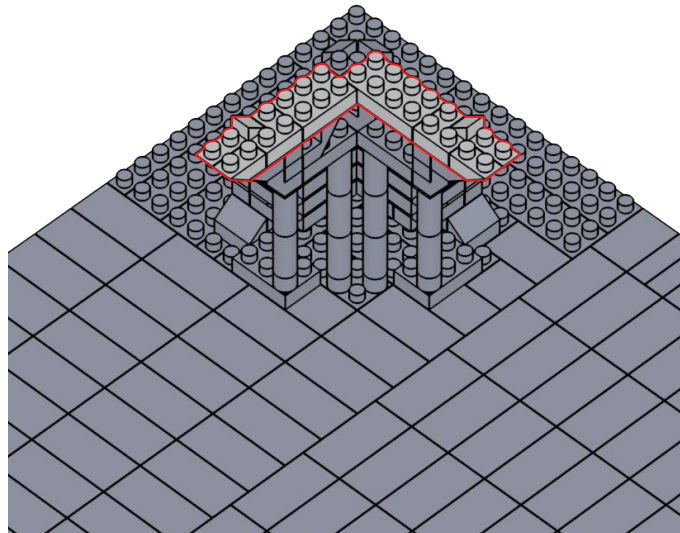

22

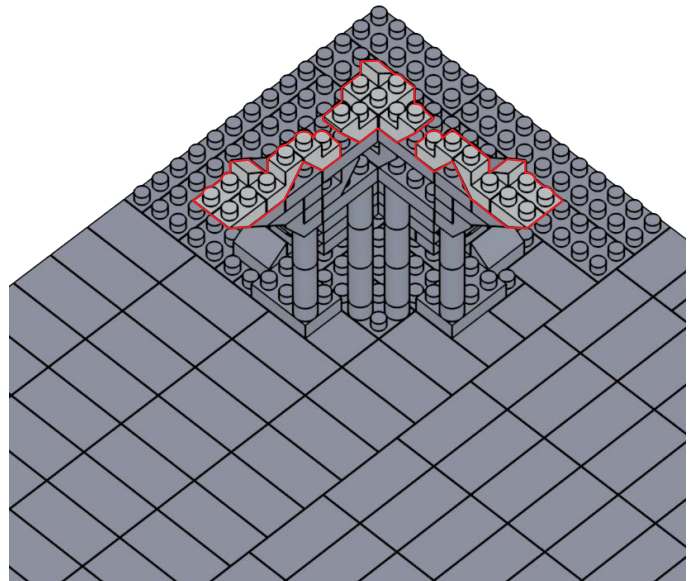

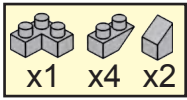

23

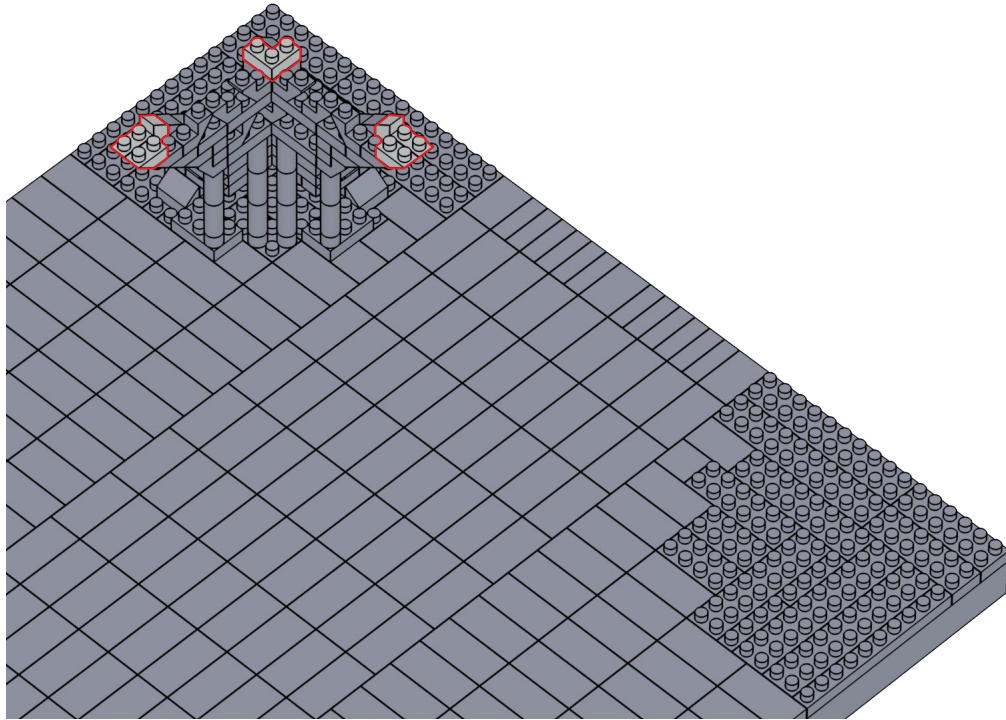

* are transparent building blocks

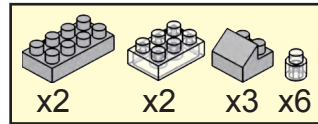

24

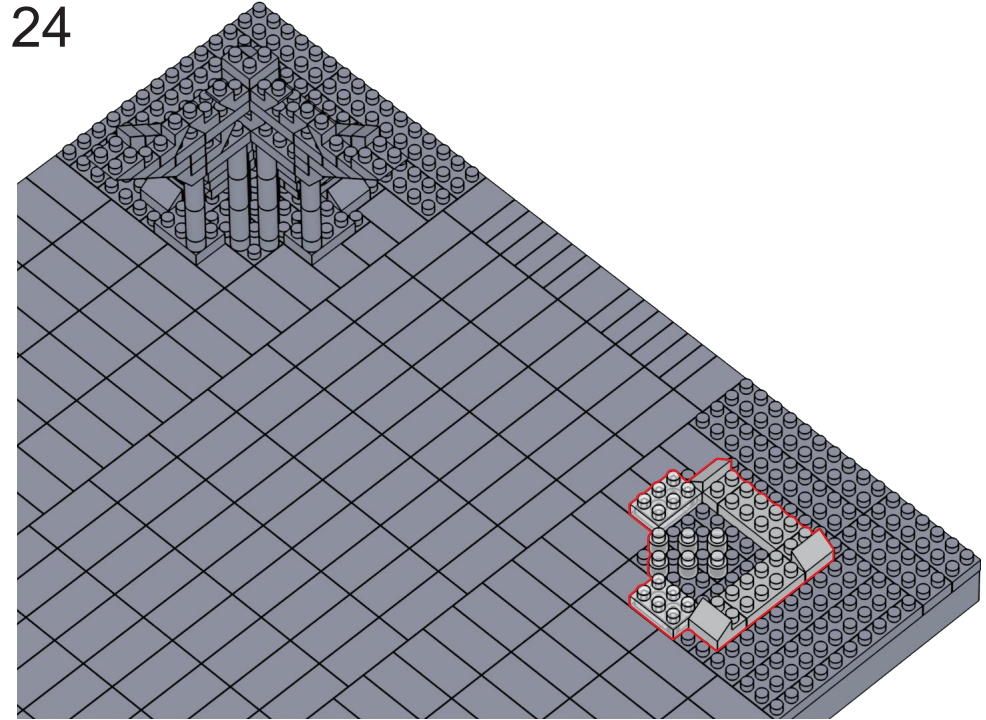

* are transparent building blocks

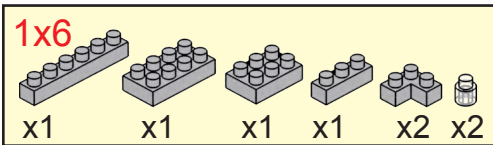

25

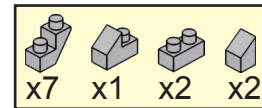
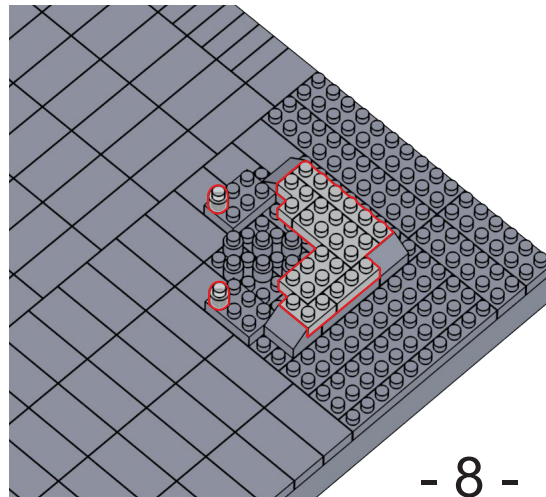

26

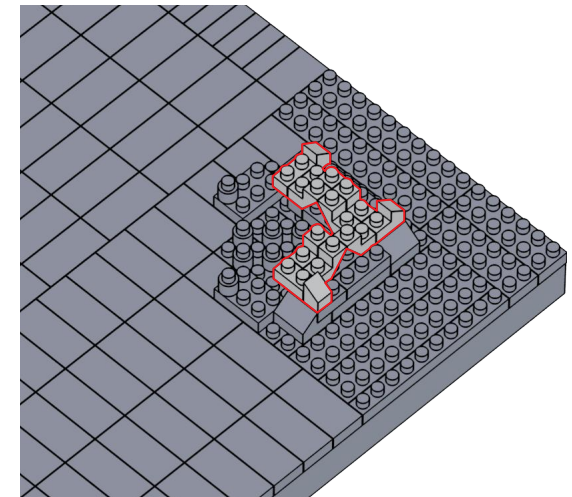

*  are transparent building blocks

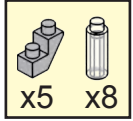

27

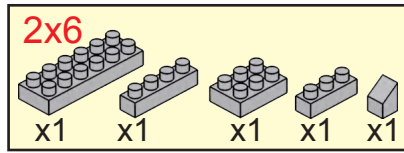
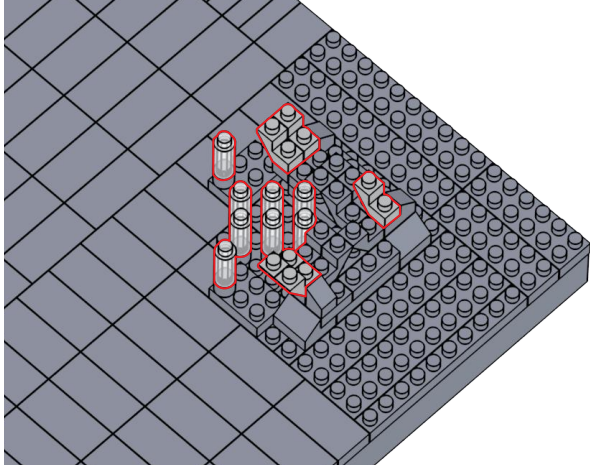

28

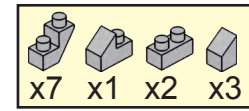
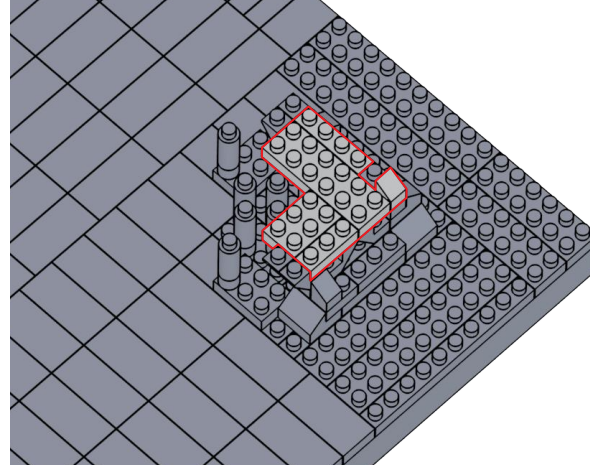

29

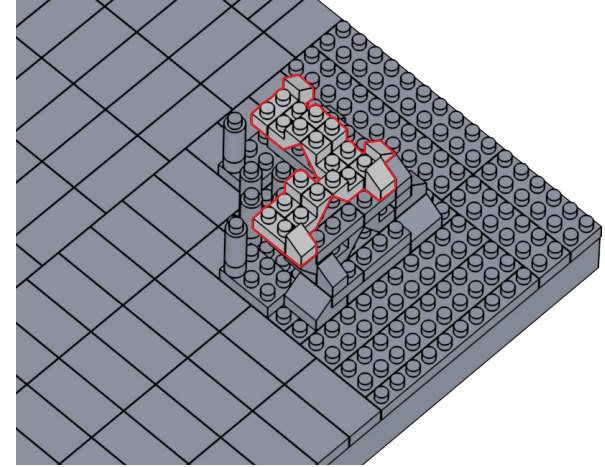

*  are transparent building blocks

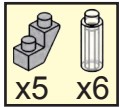

30

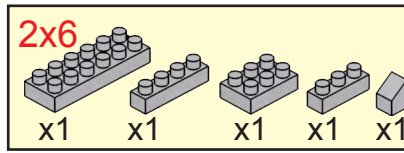
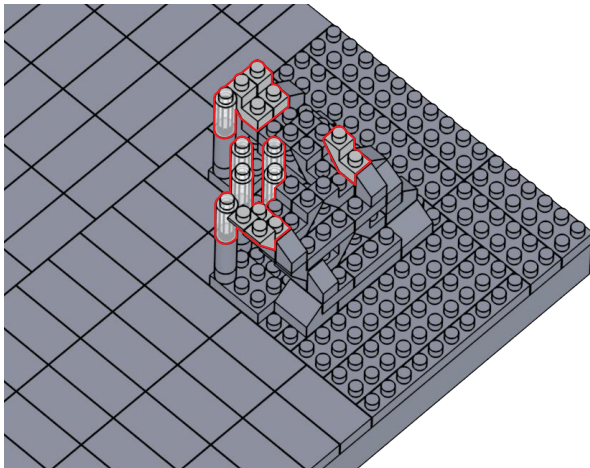

31

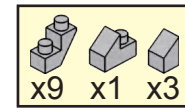
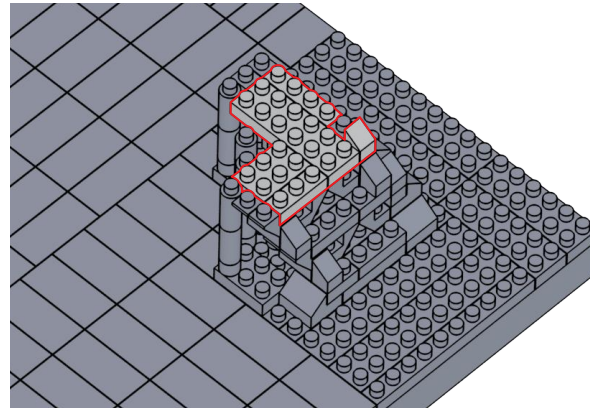

32

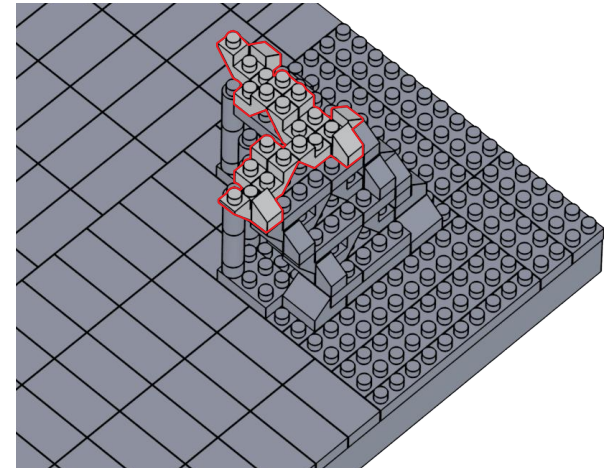

*  are transparent building blocks

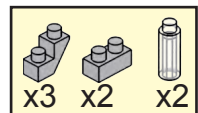

33

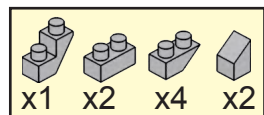
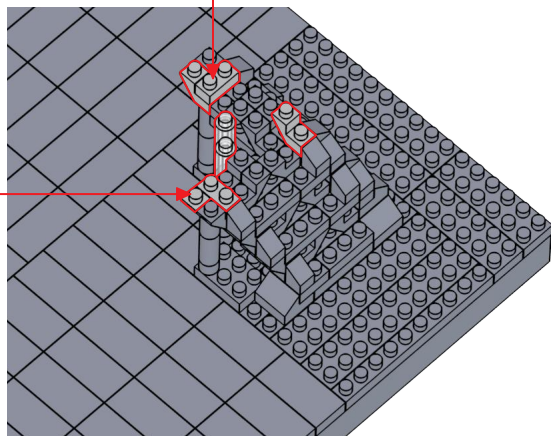
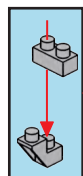
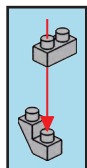

36

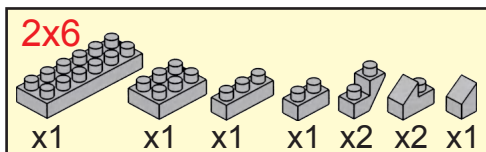
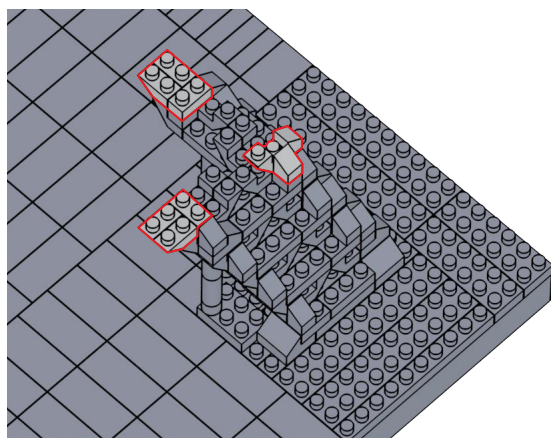

34

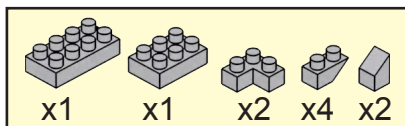
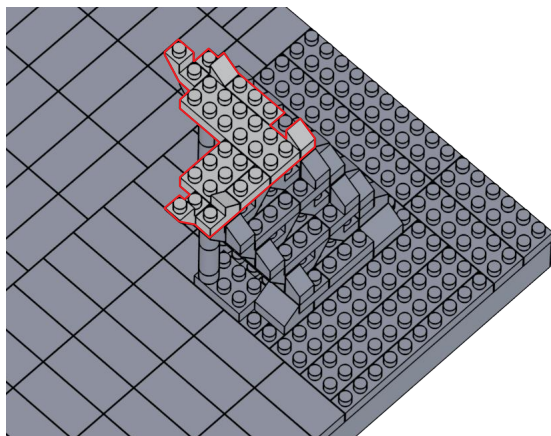

37

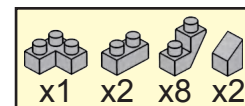
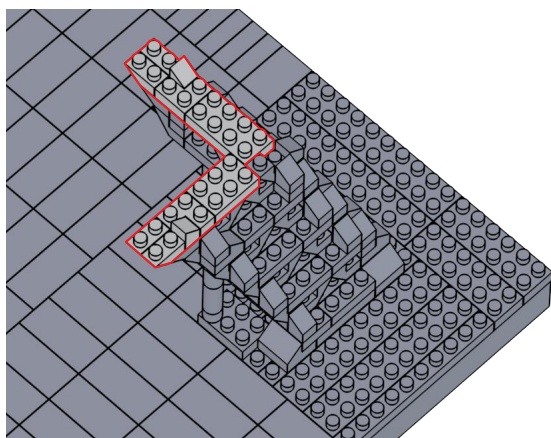

35

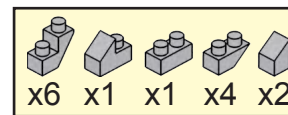
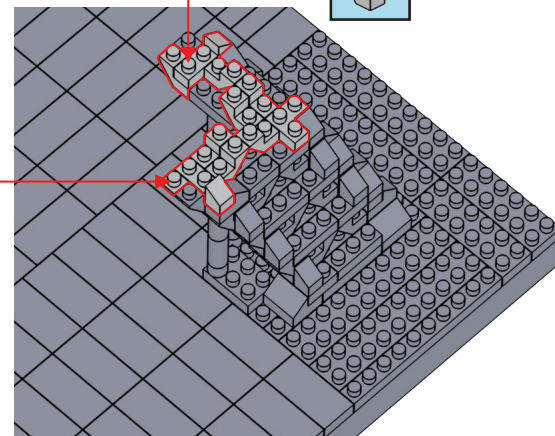
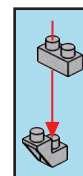

38

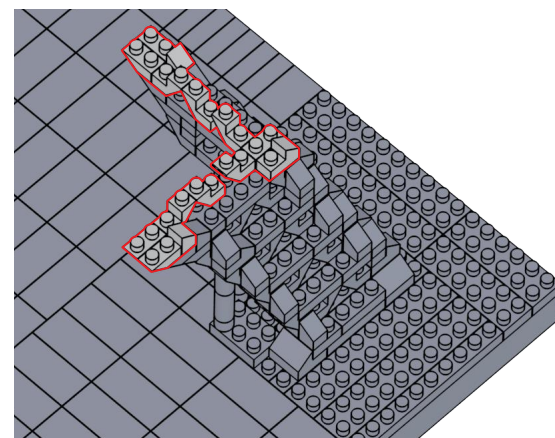

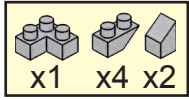

39

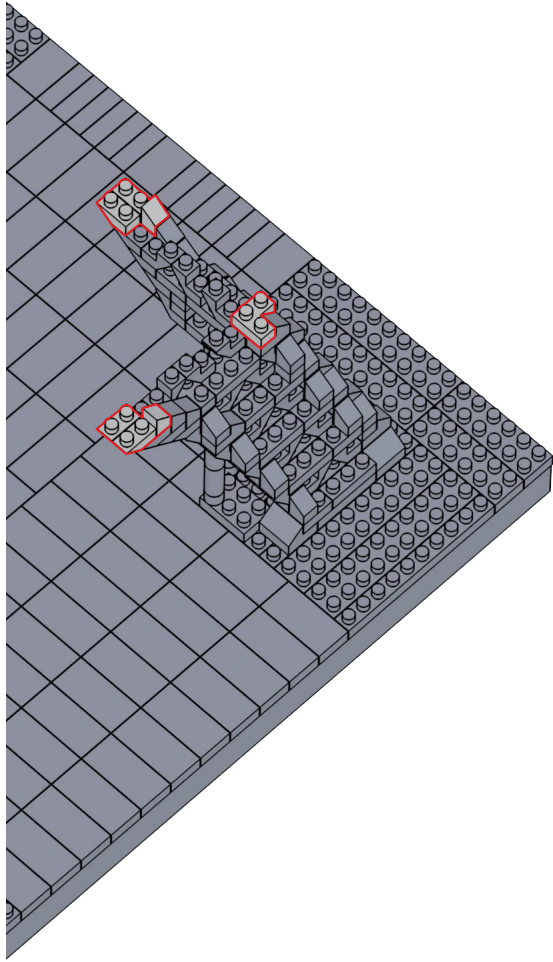

40

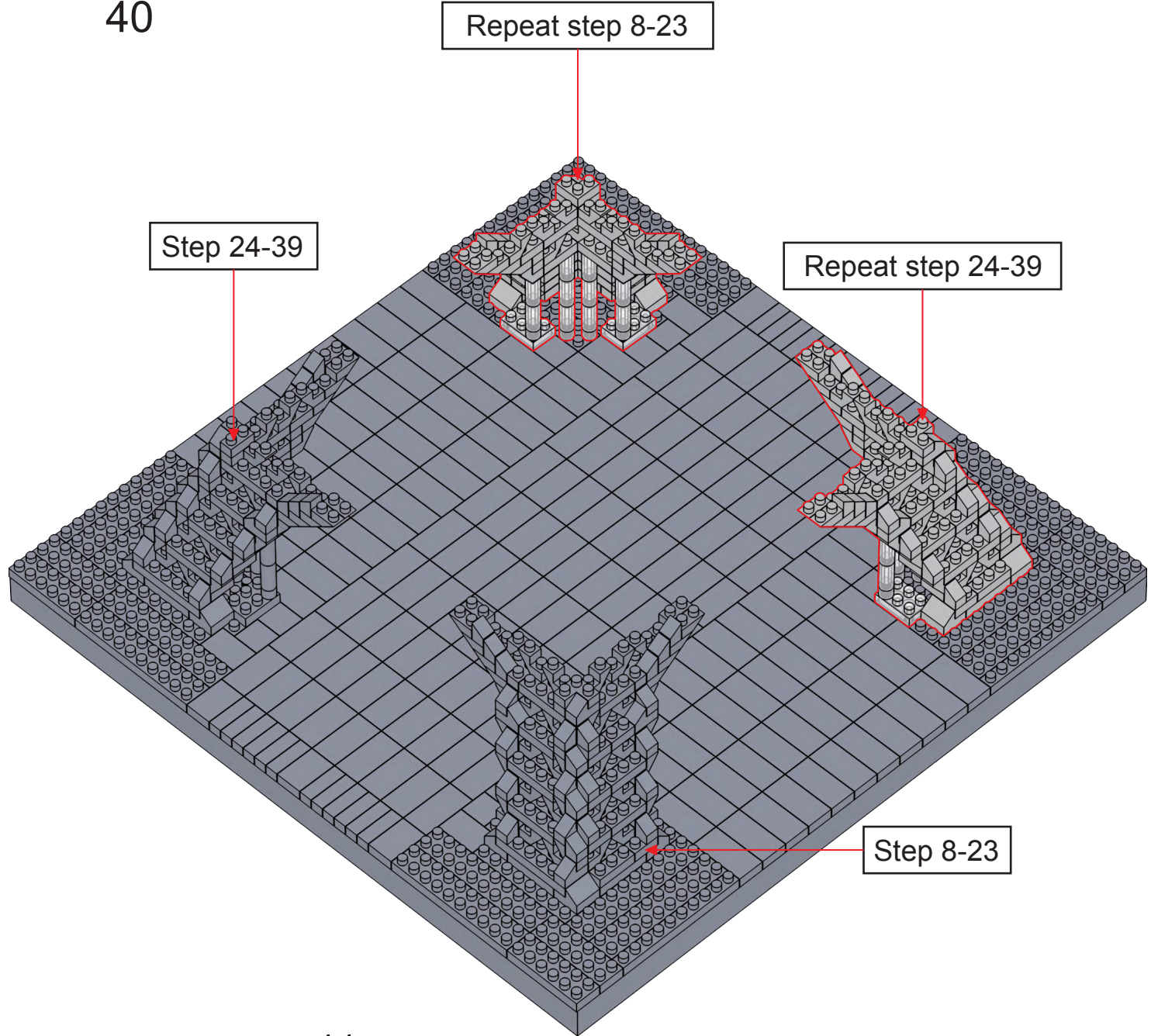

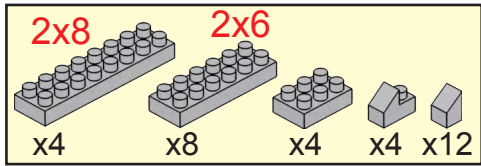

41

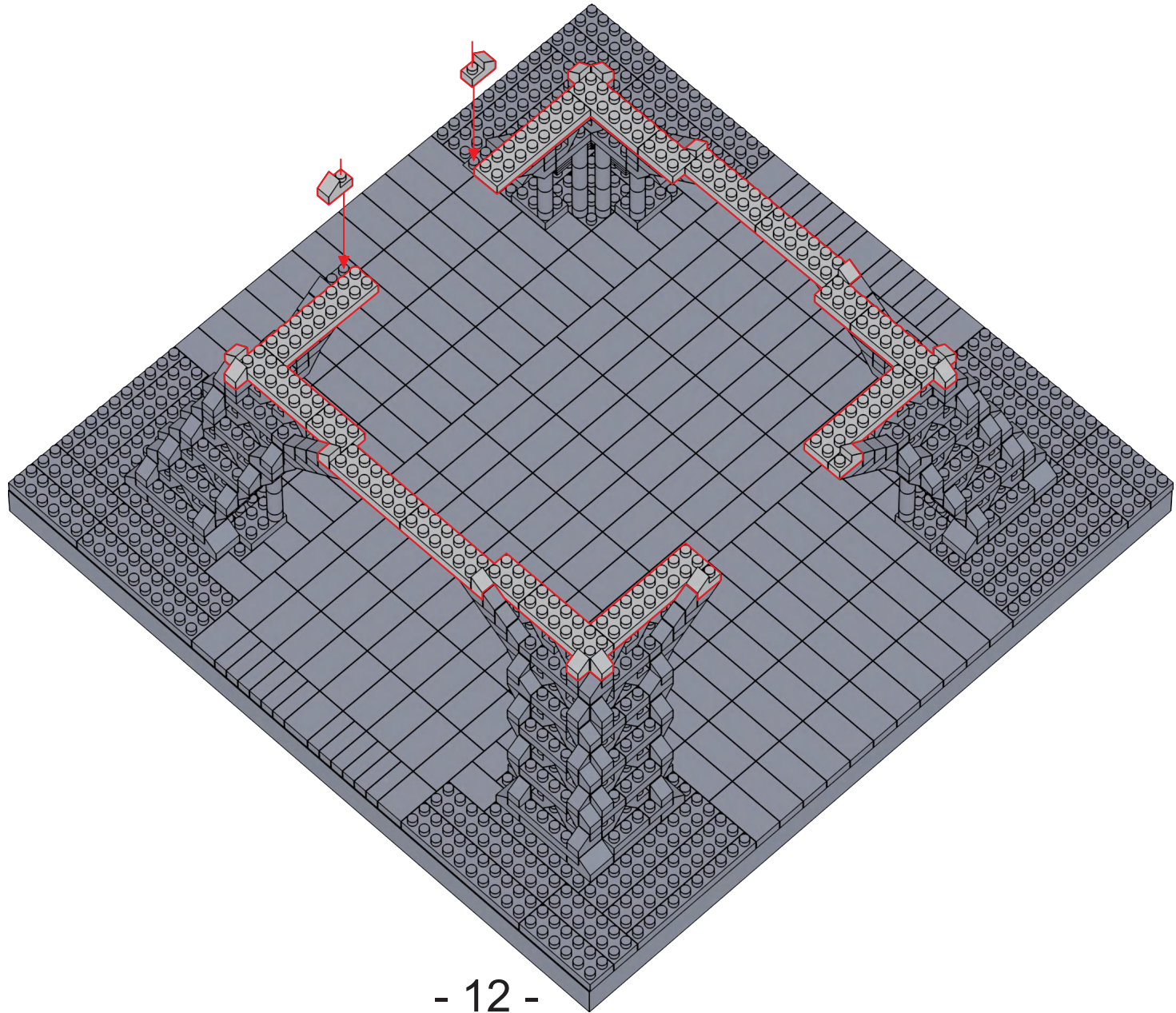

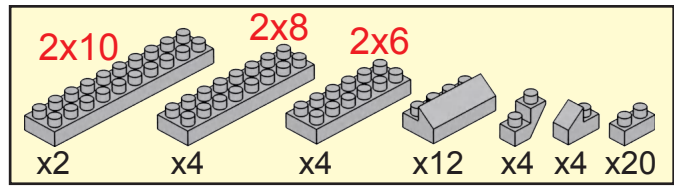

42

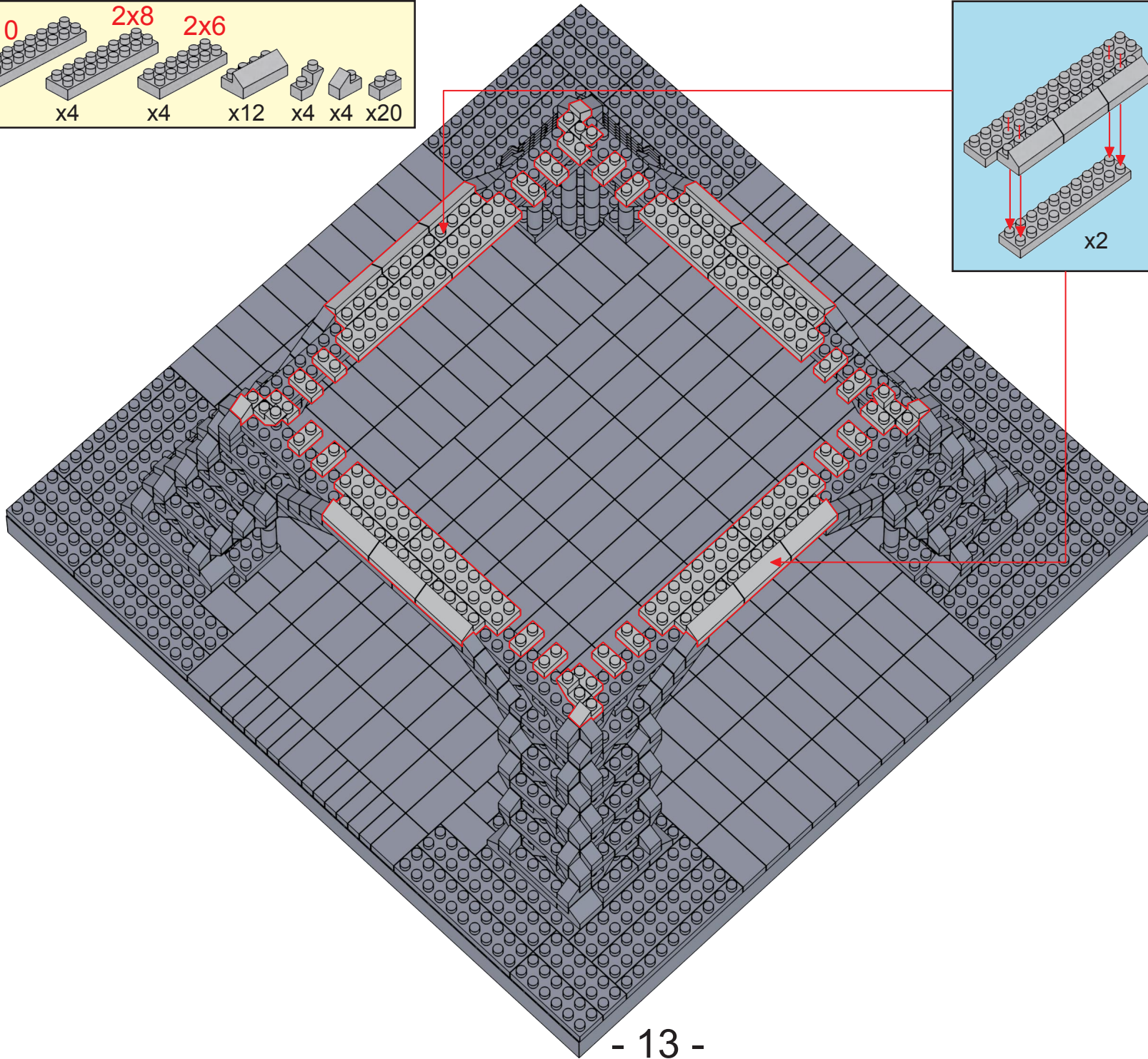
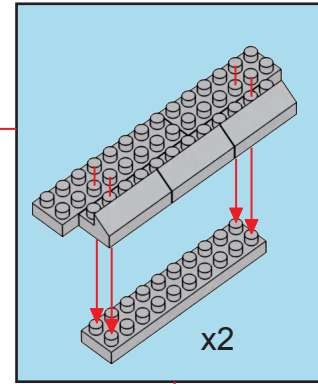

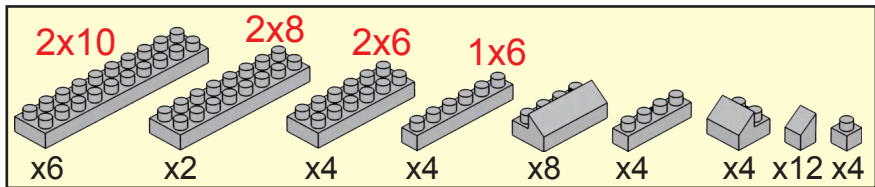

43

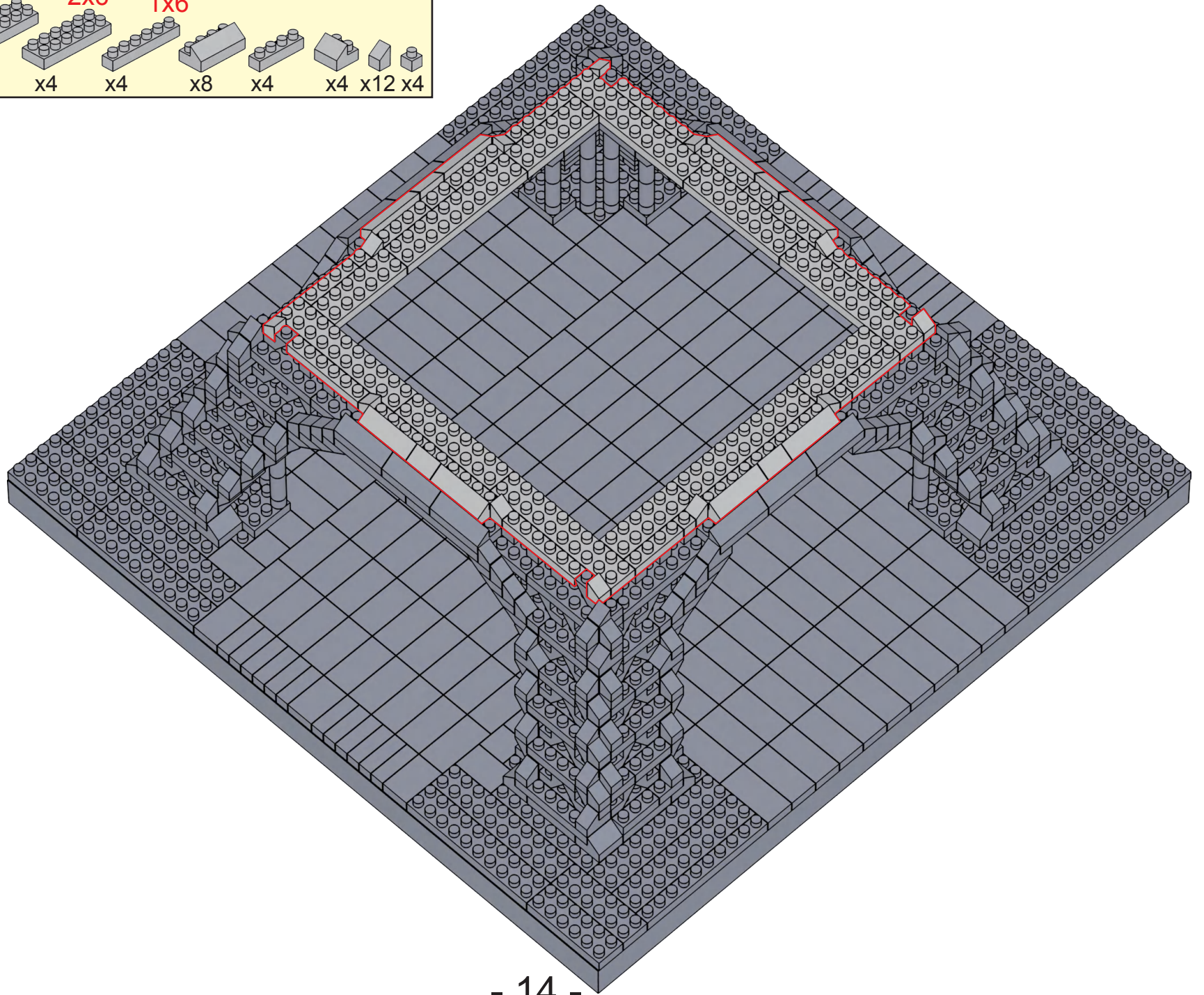

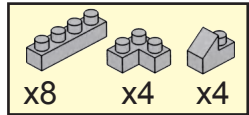

44

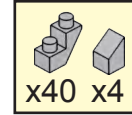
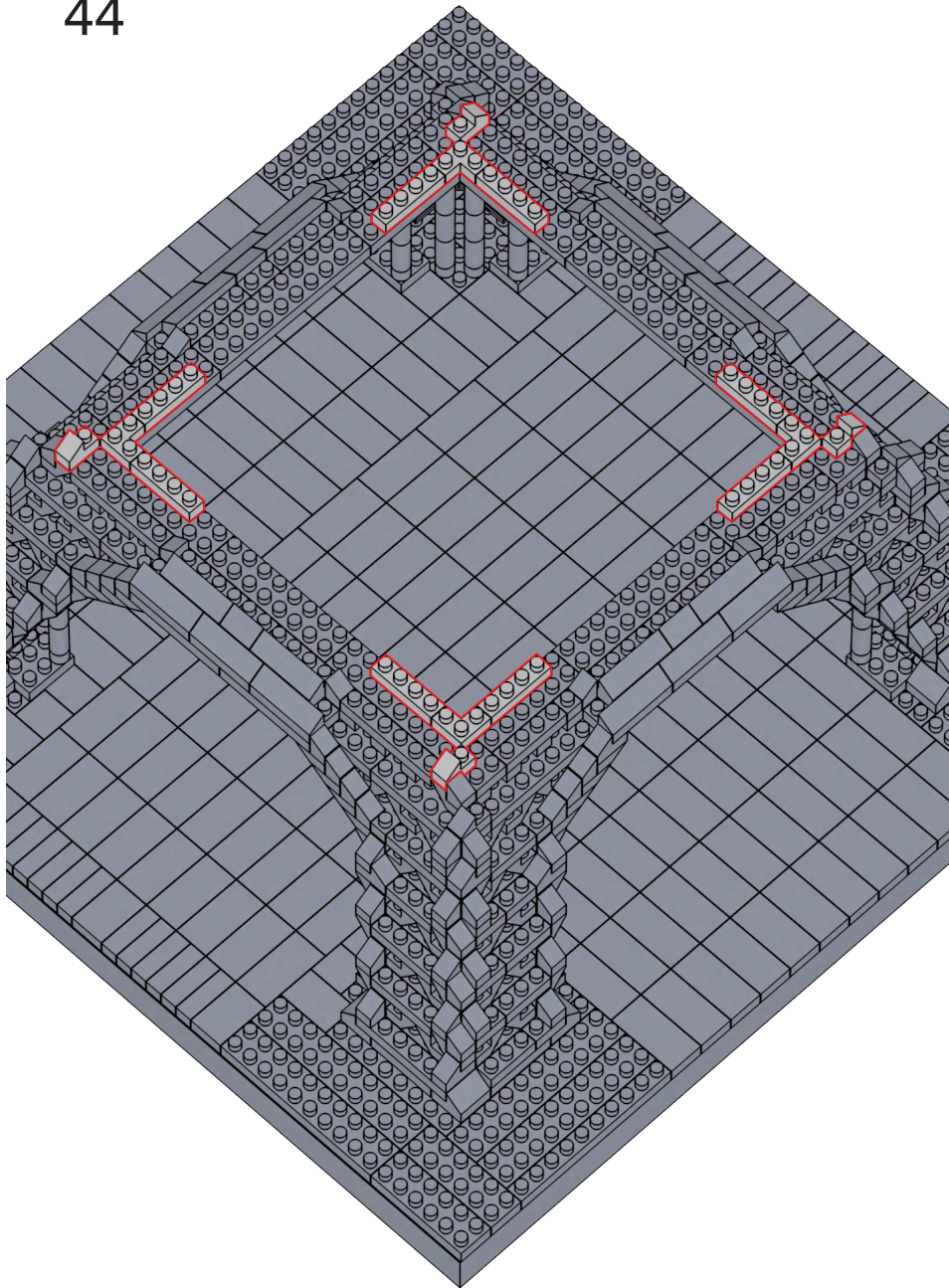

45

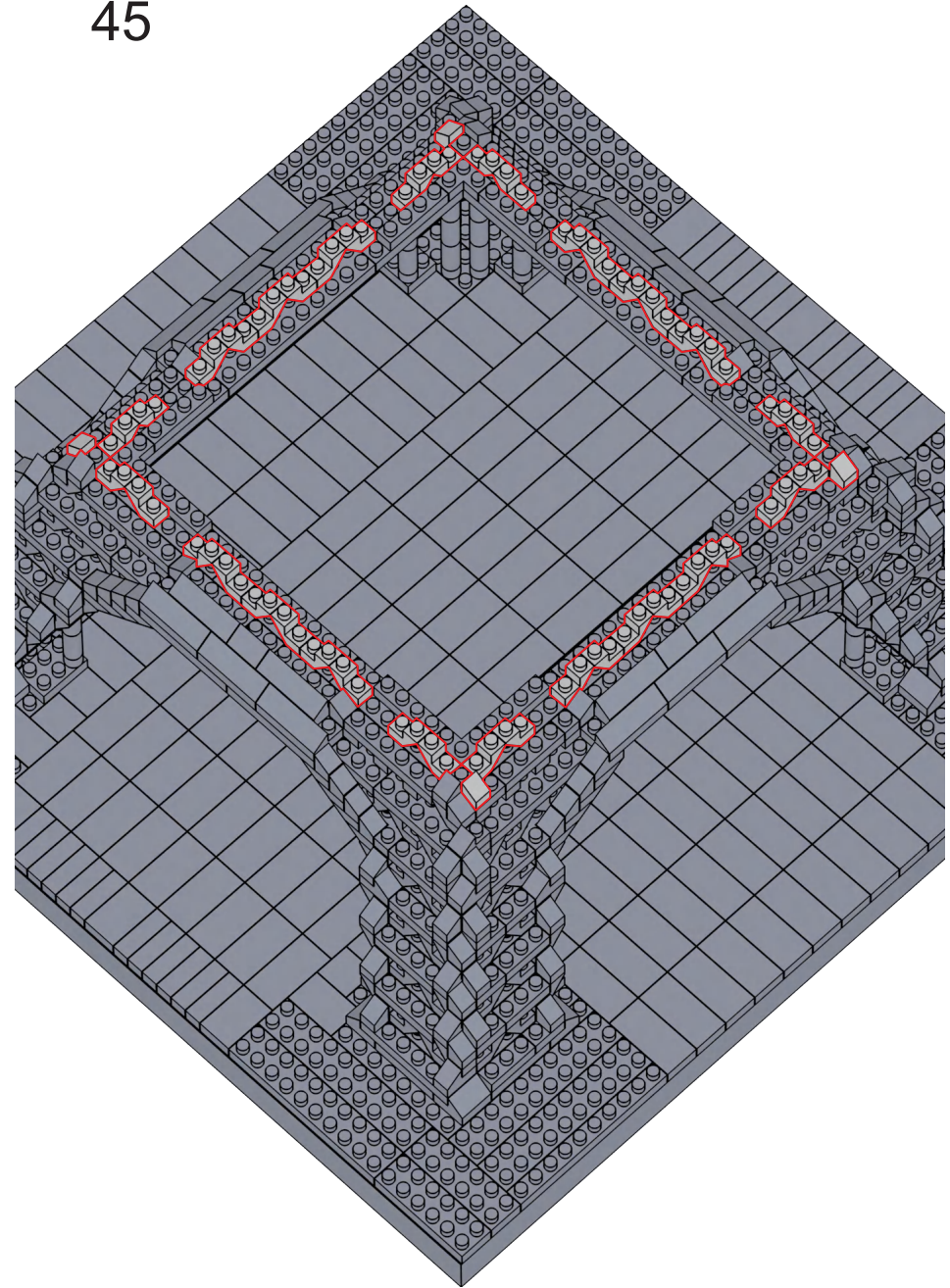

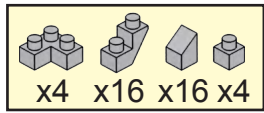

46

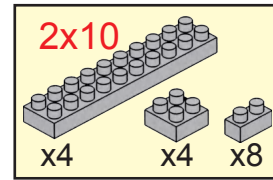
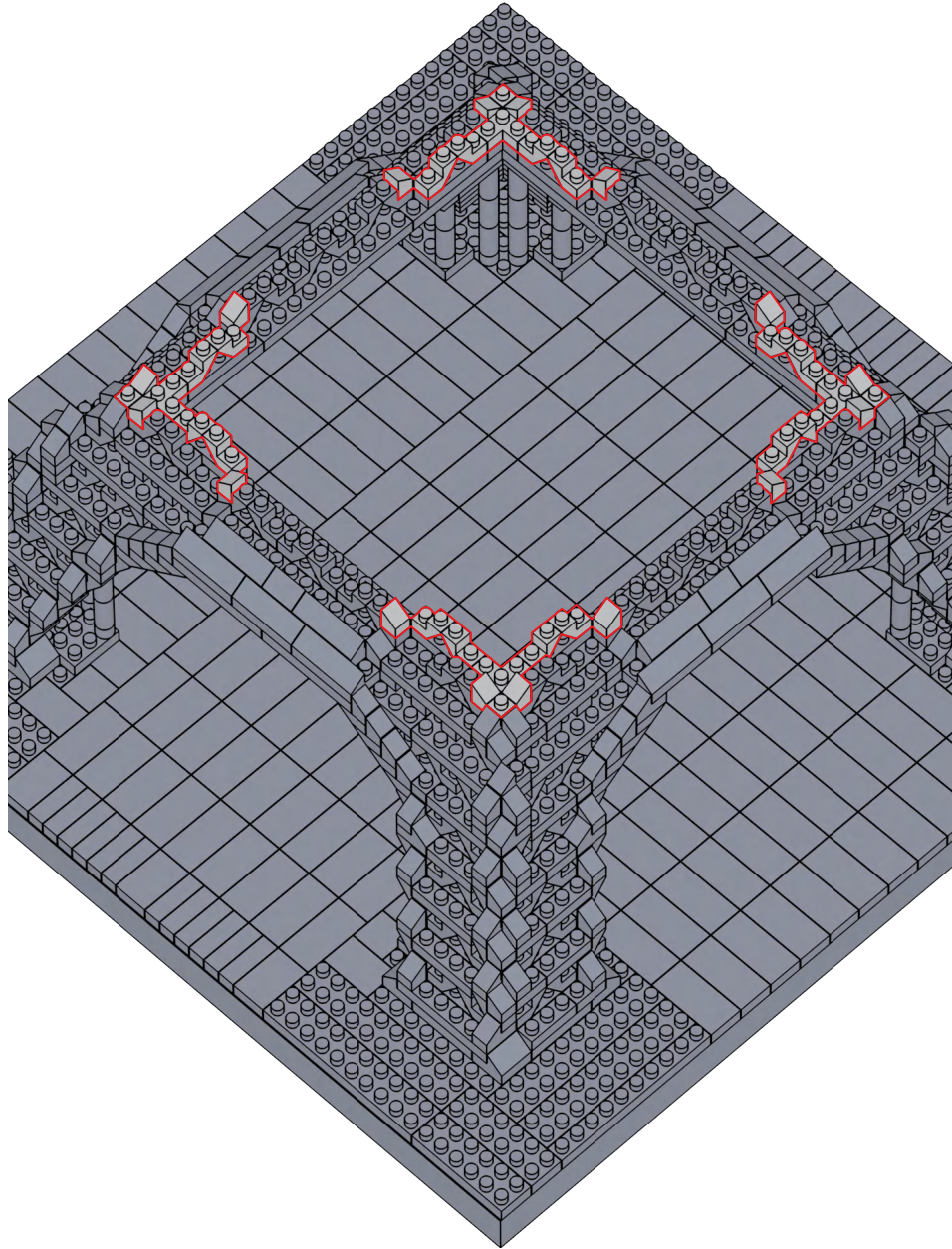

47

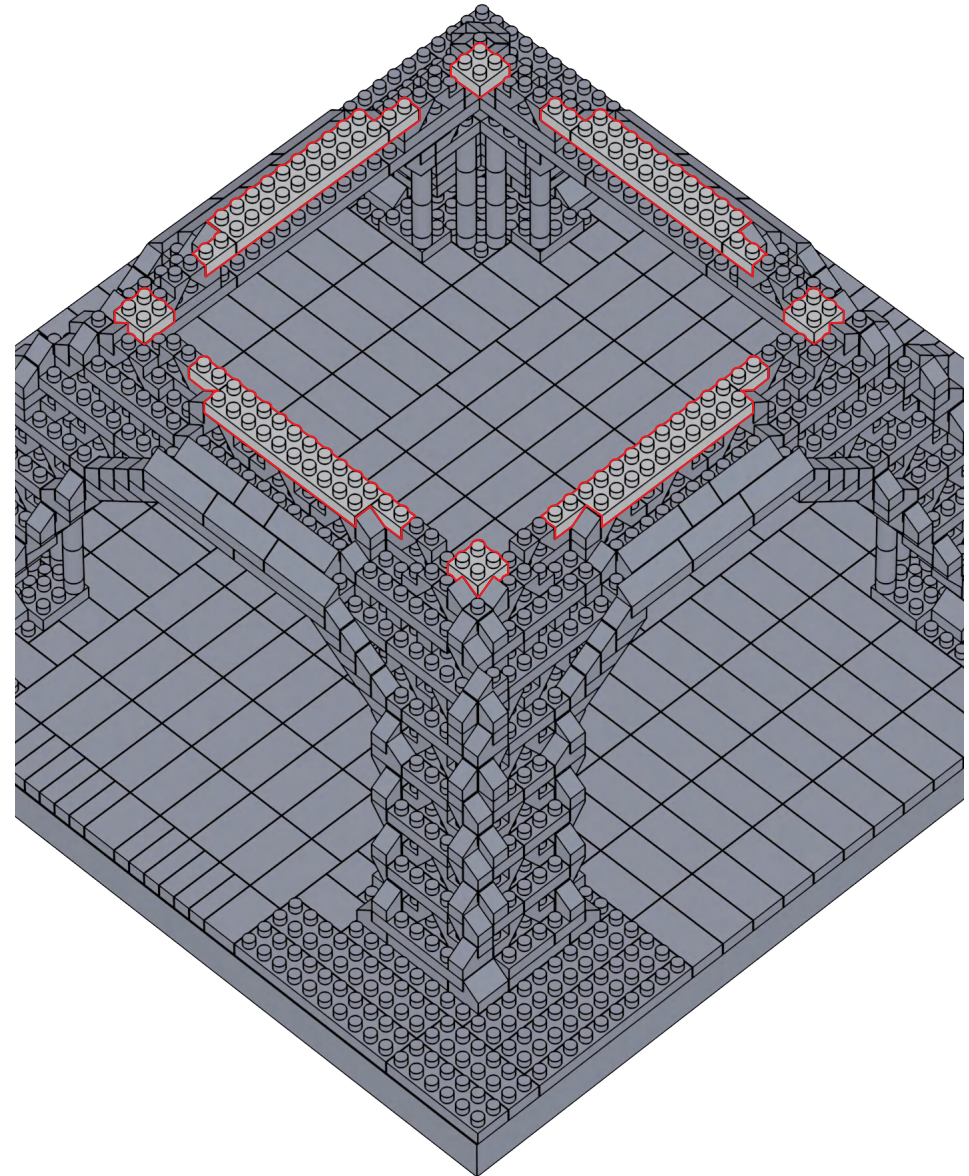

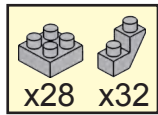

48

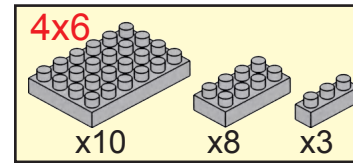
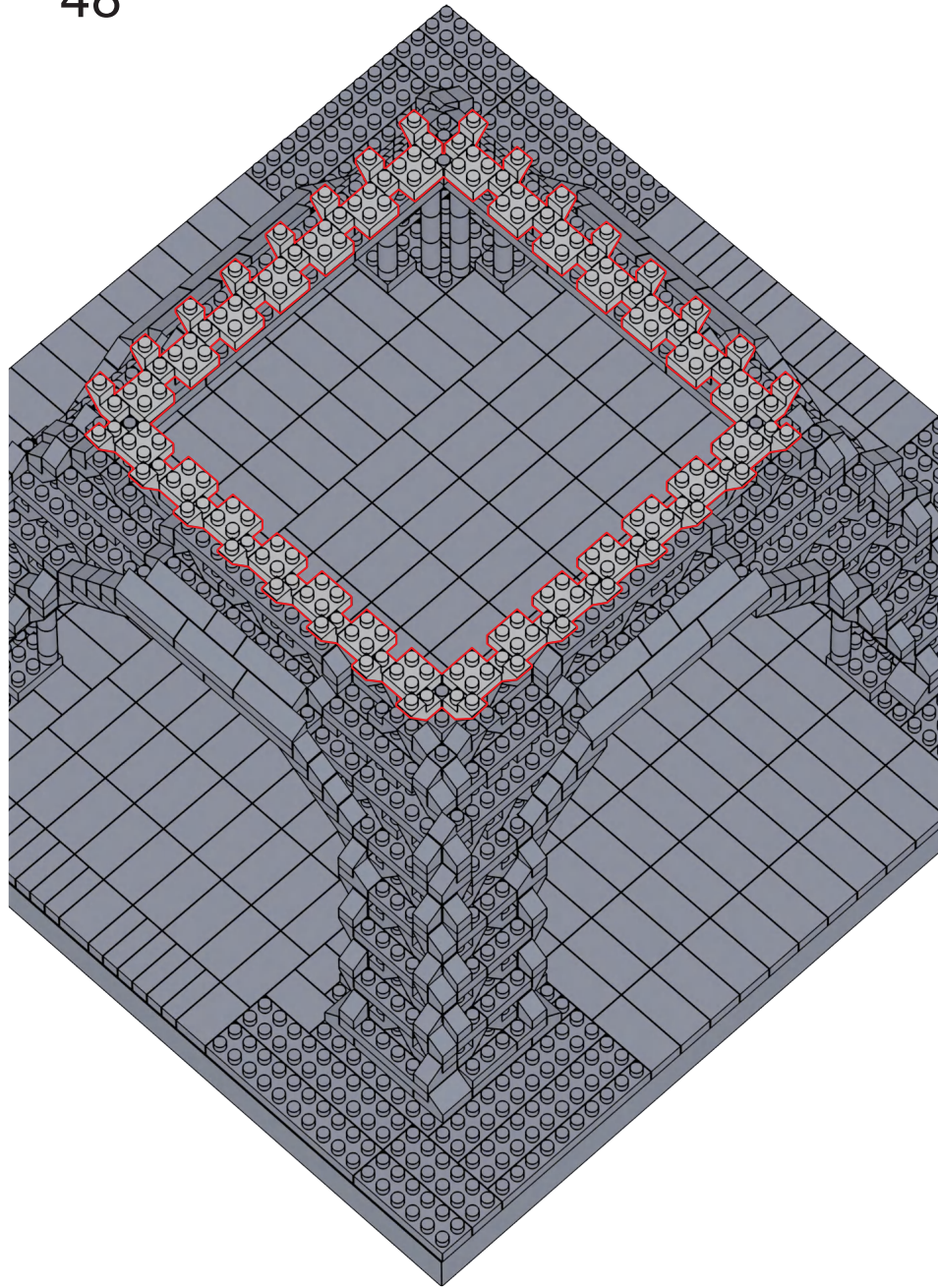

49

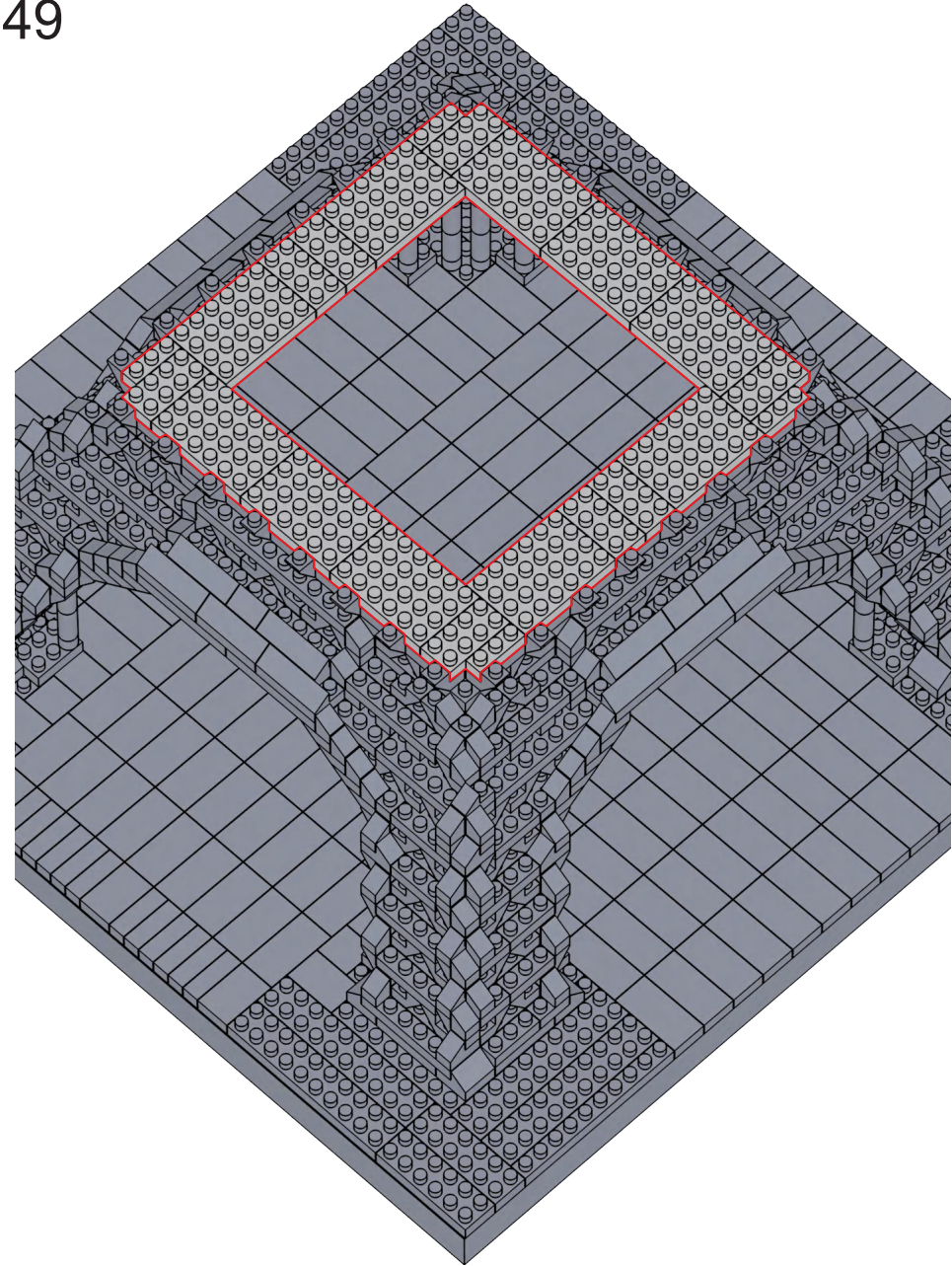

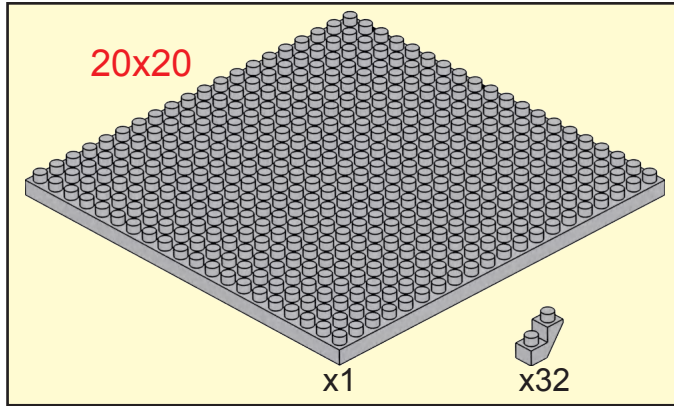

50



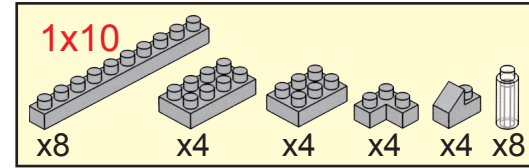

*  are transparent building blocks

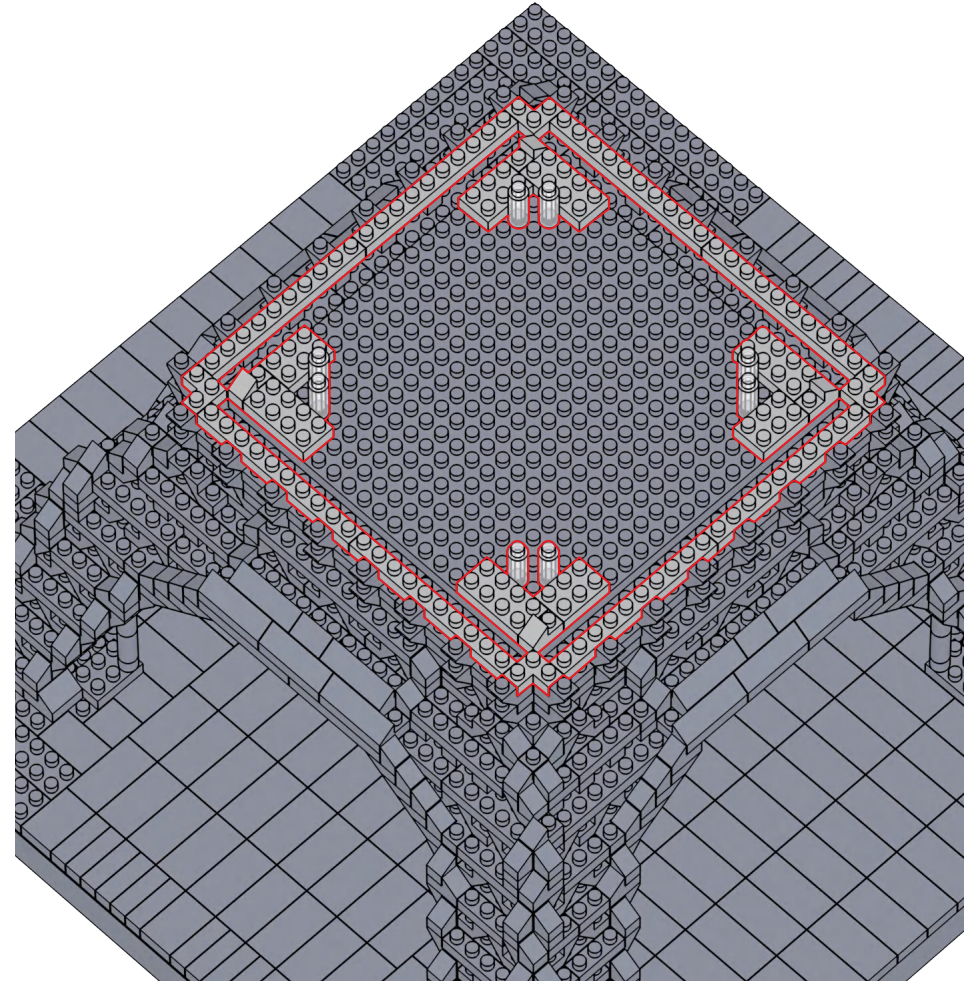
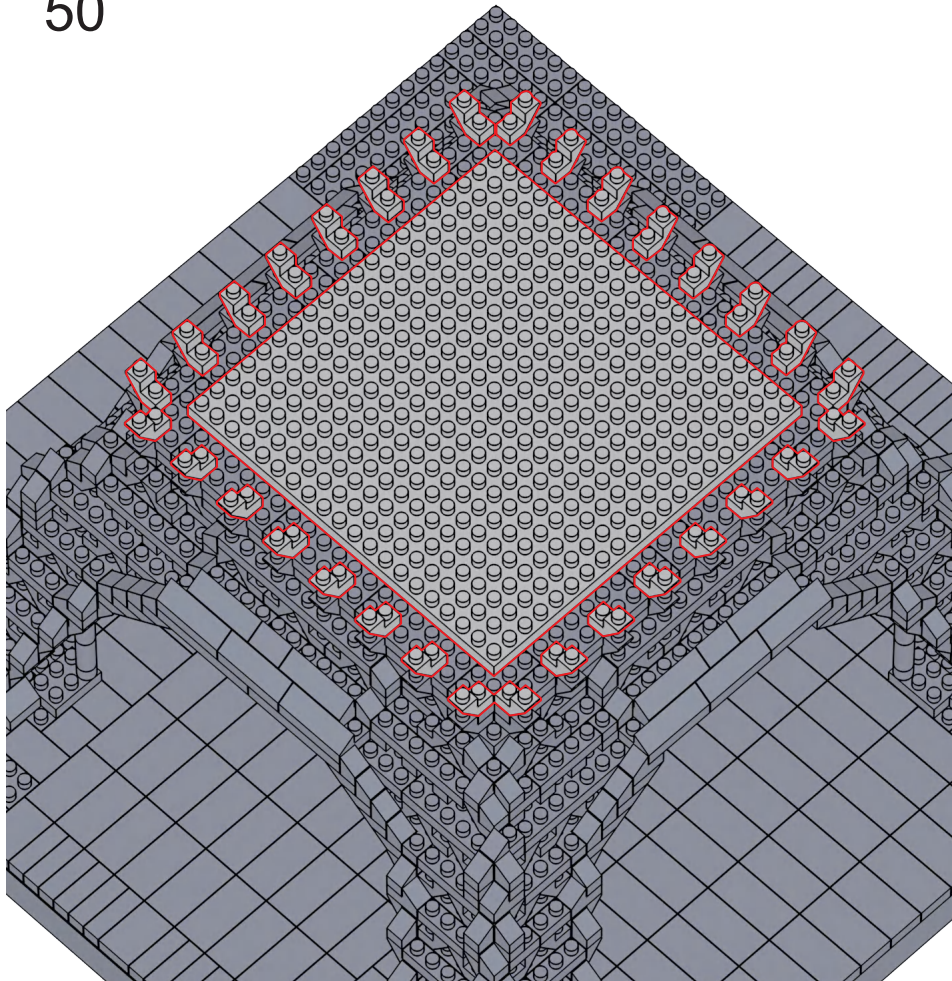

51



*  are transparent building blocks

 x8  x4  x44  x8

52

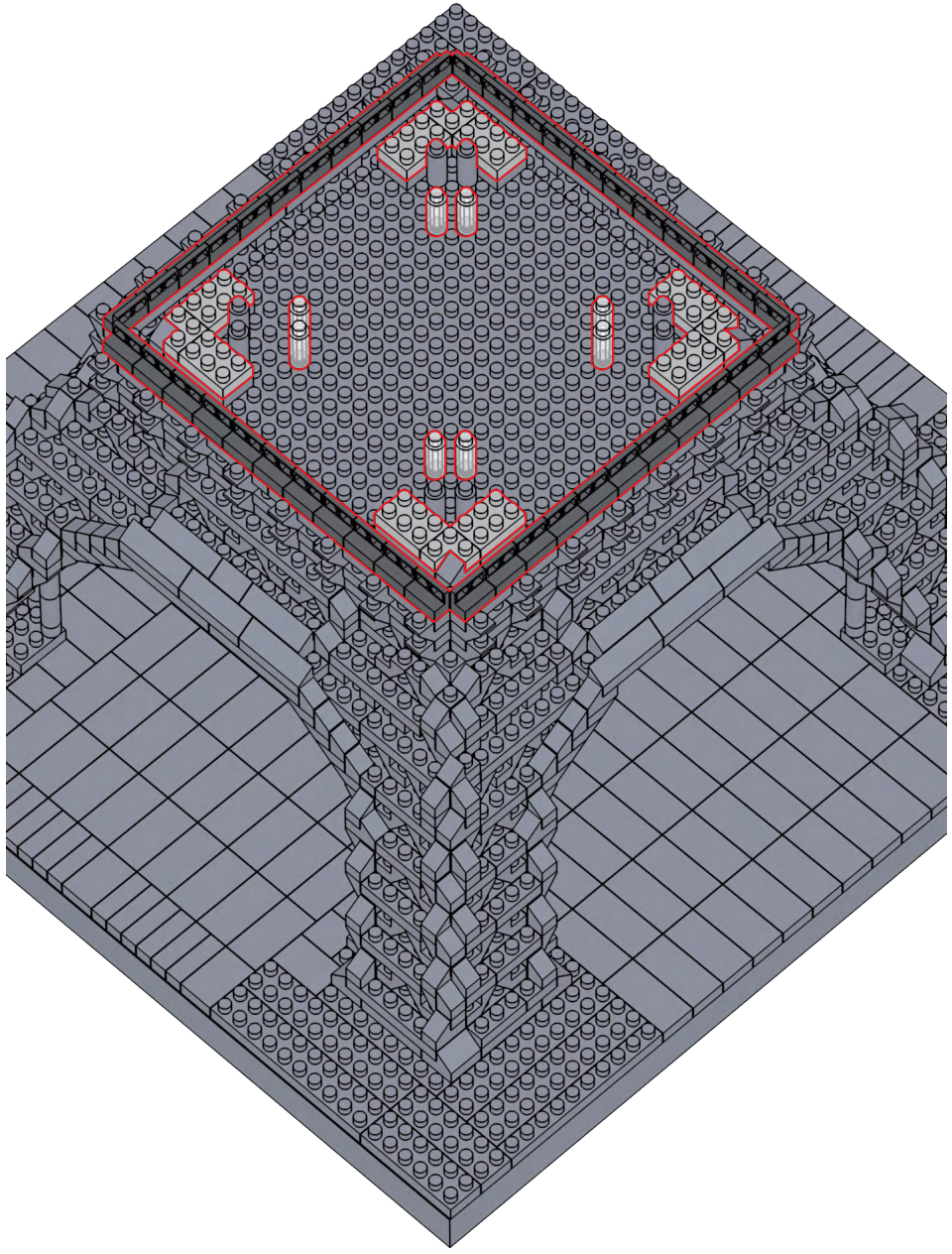

 x28

53

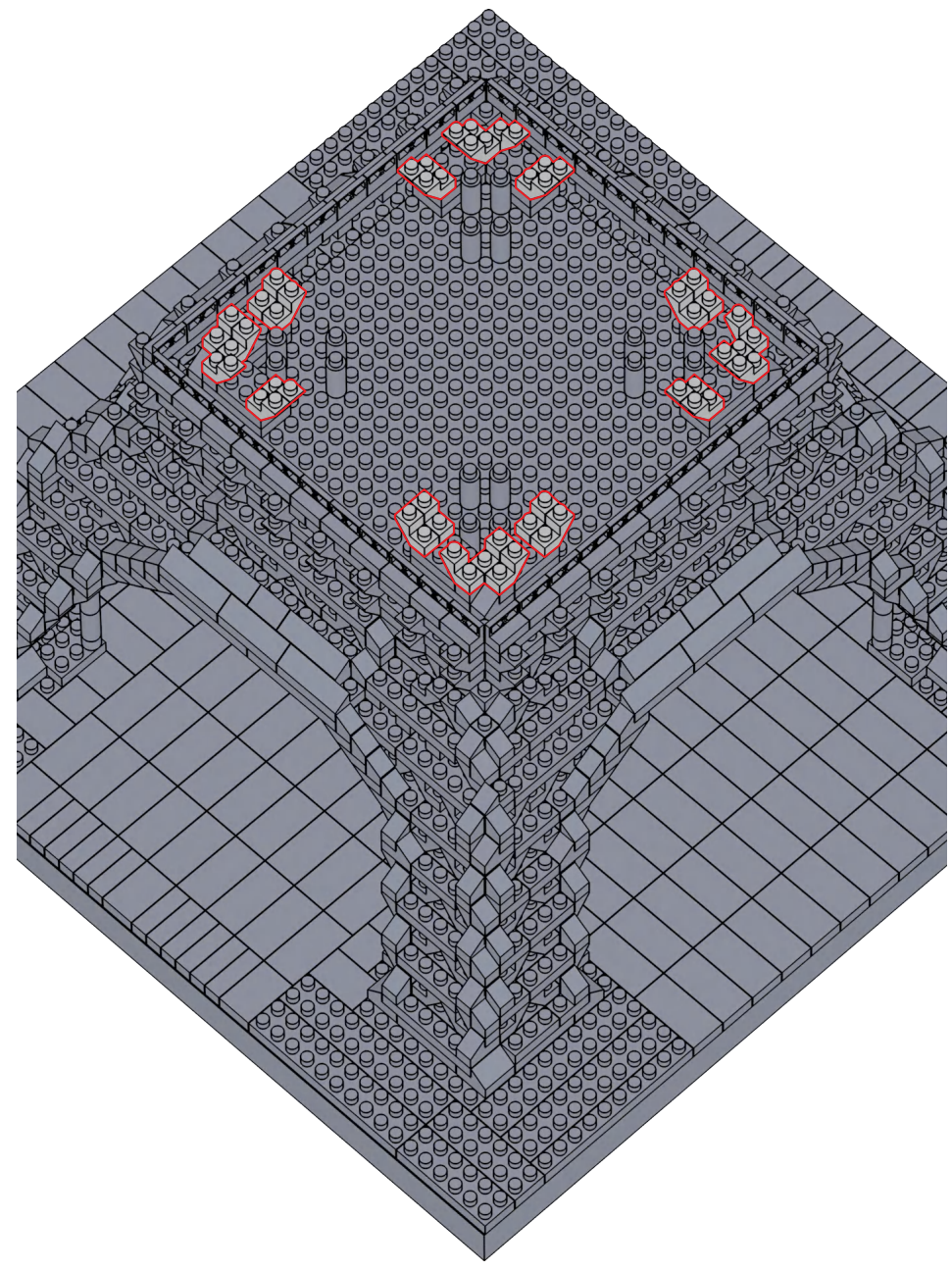

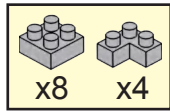

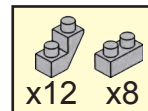
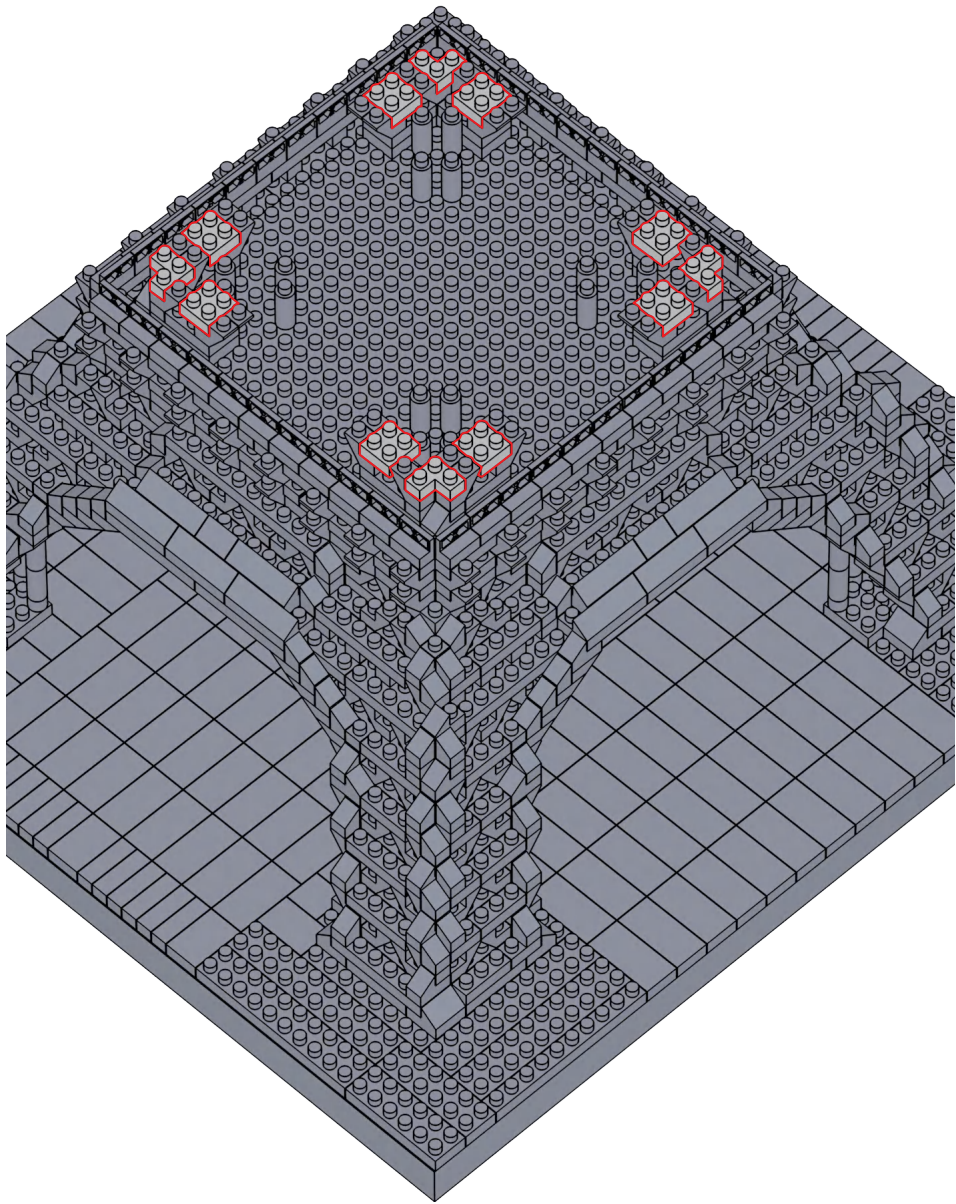

54

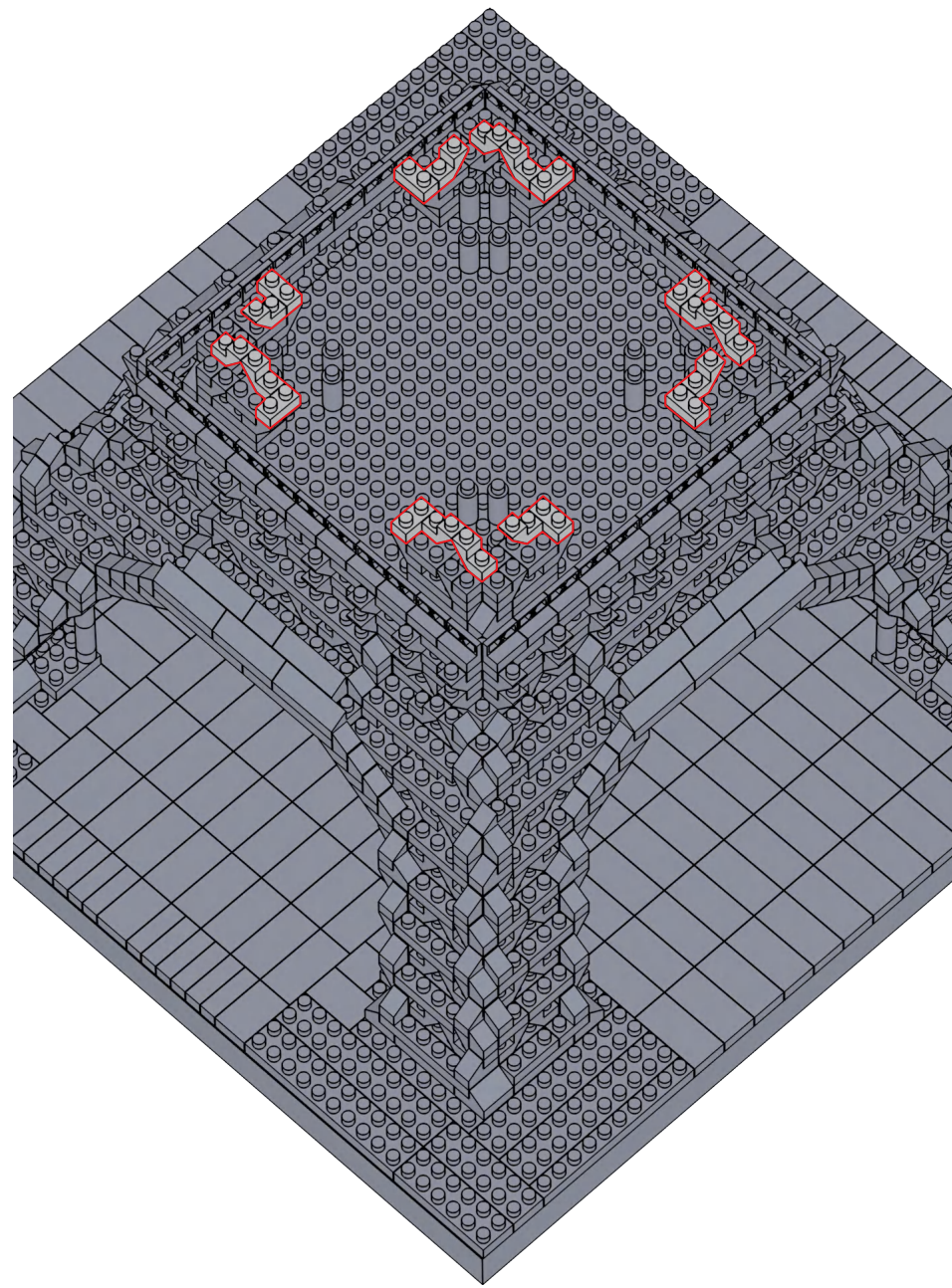

55



*  are transparent building blocks

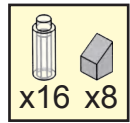

56

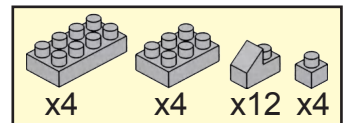
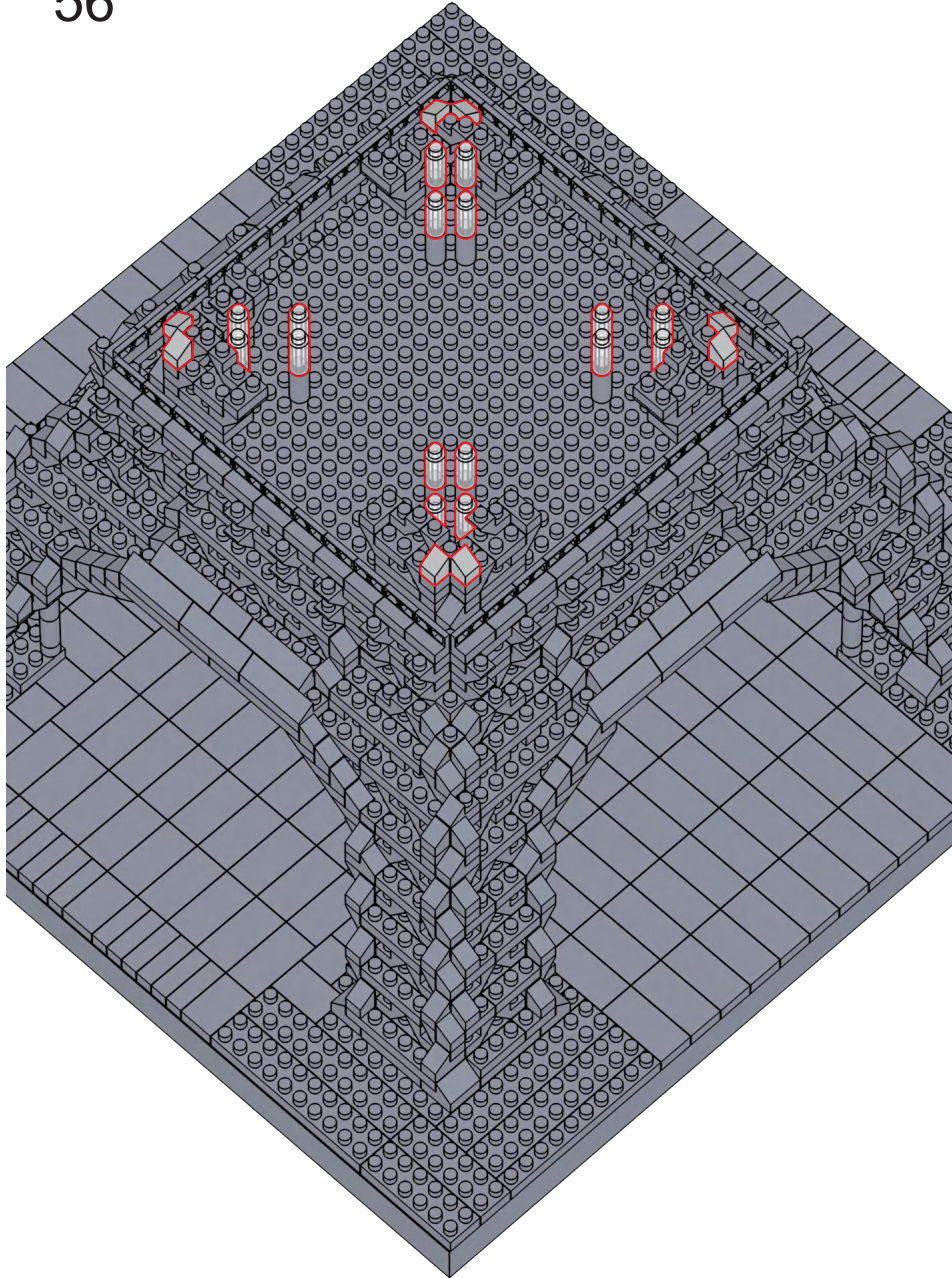

57

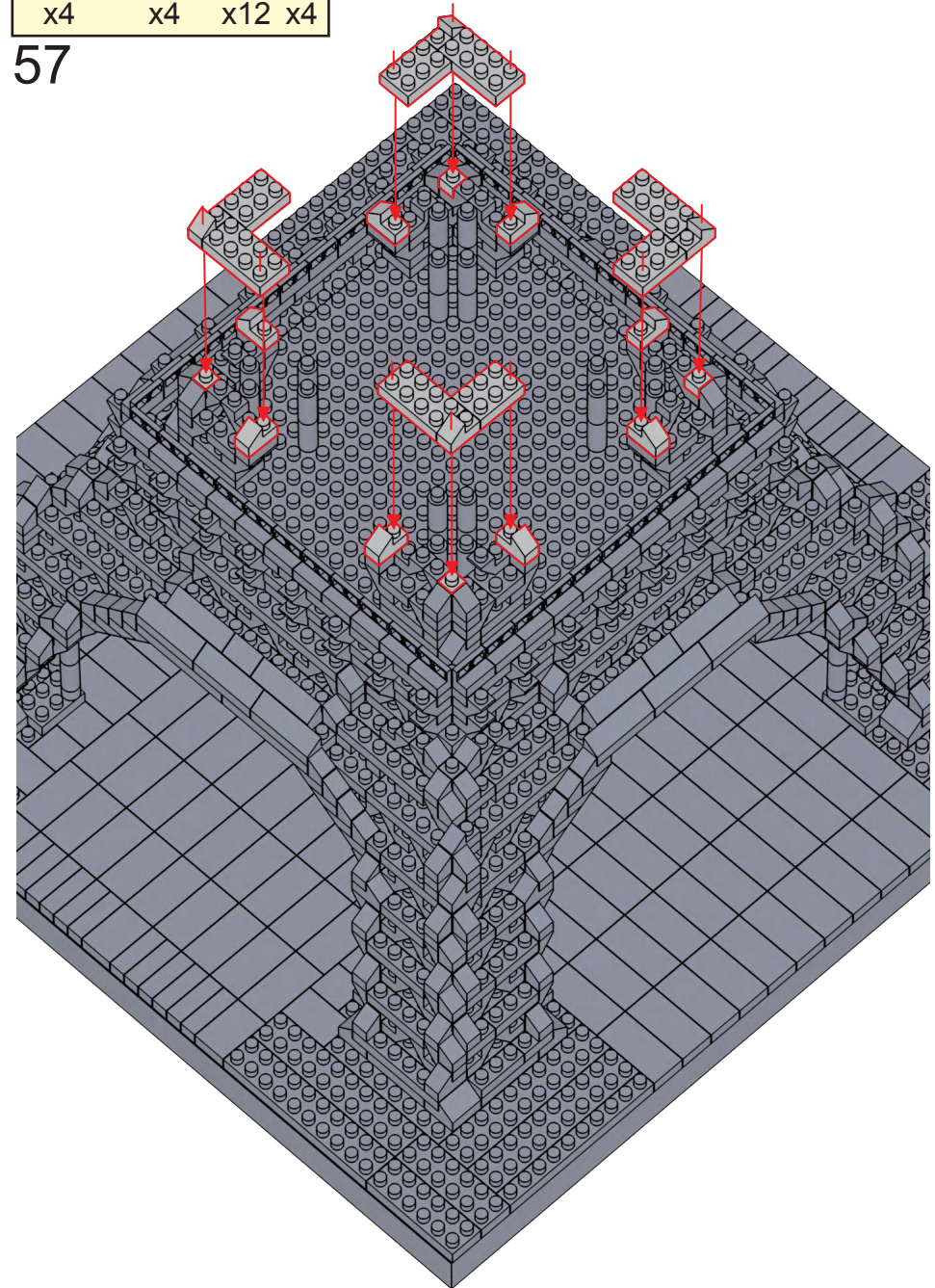

*  are transparent building blocks

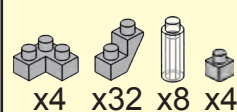

x4 x32 x8 x4

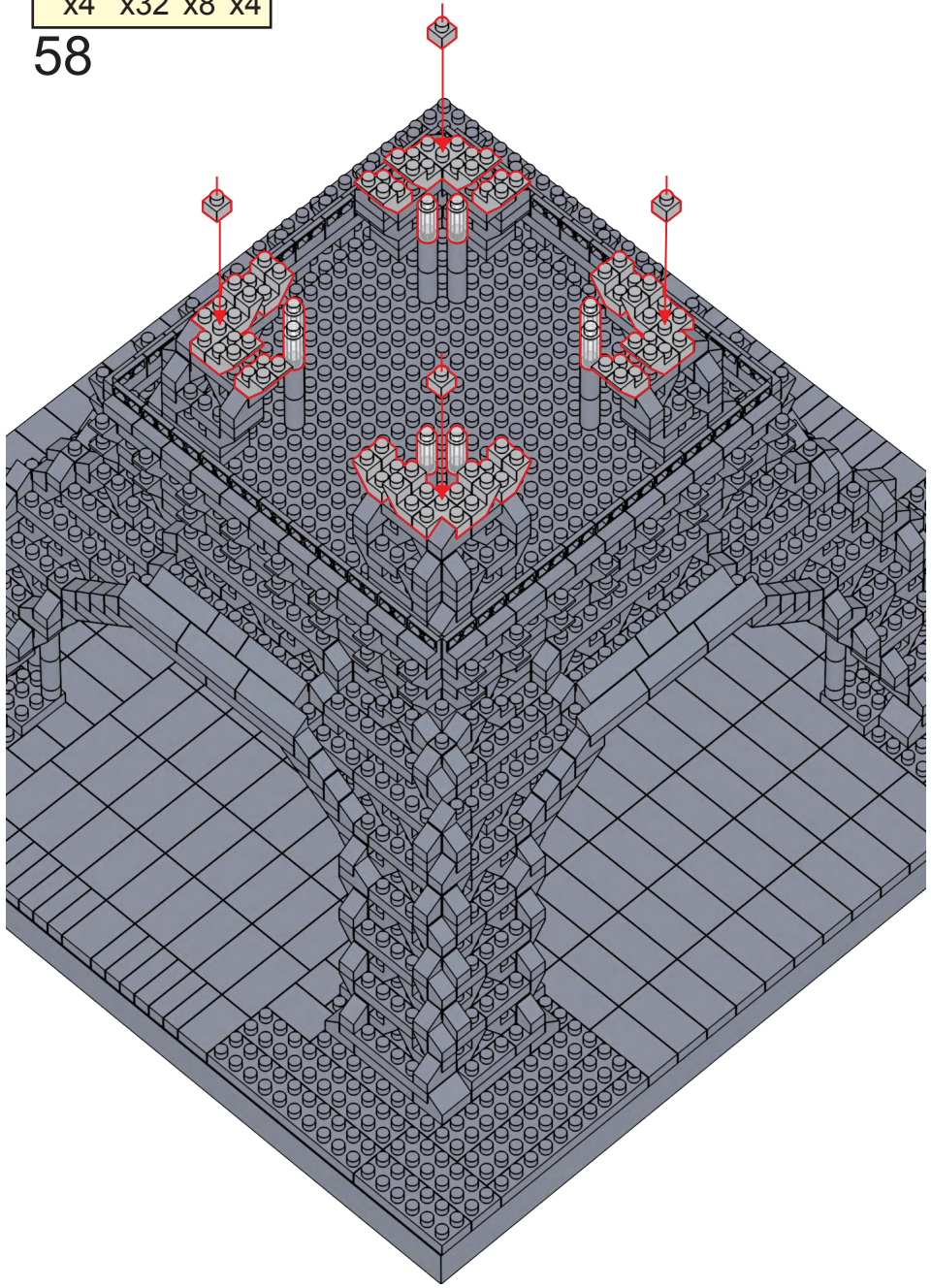
58

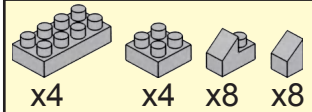

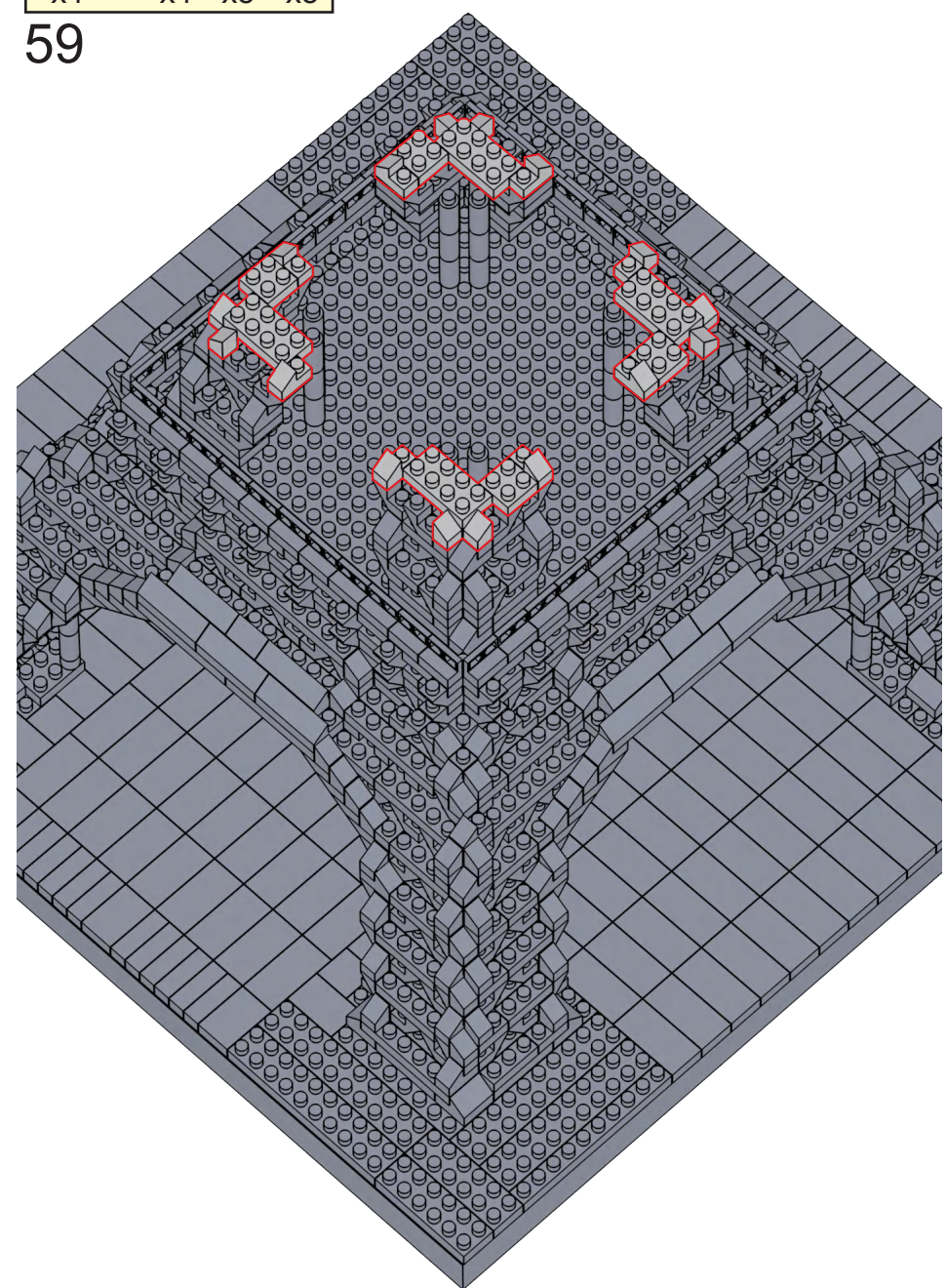

x4 x4 x8 x8

59

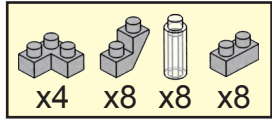

*  are transparent building blocks



60

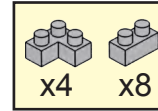
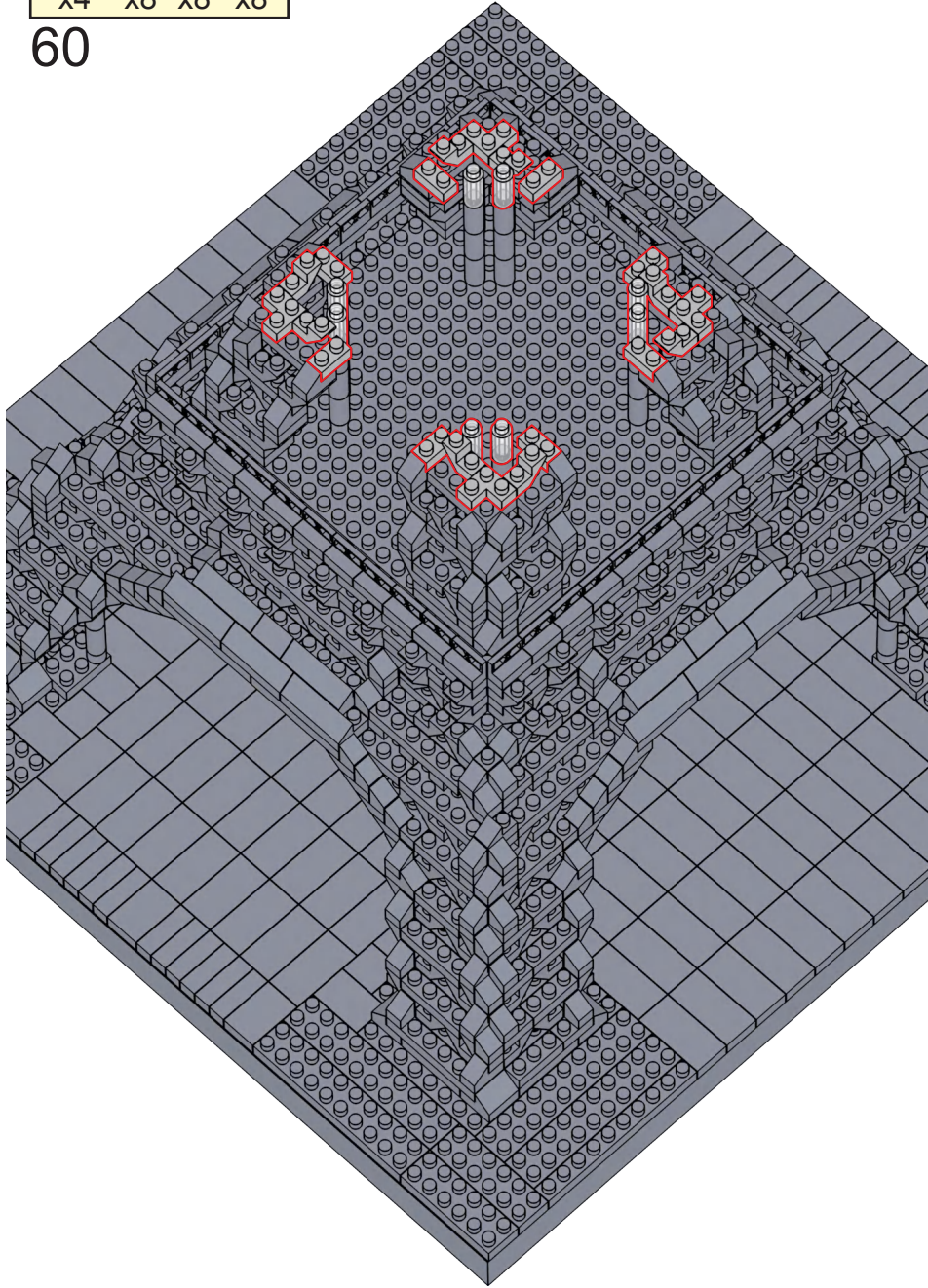

61

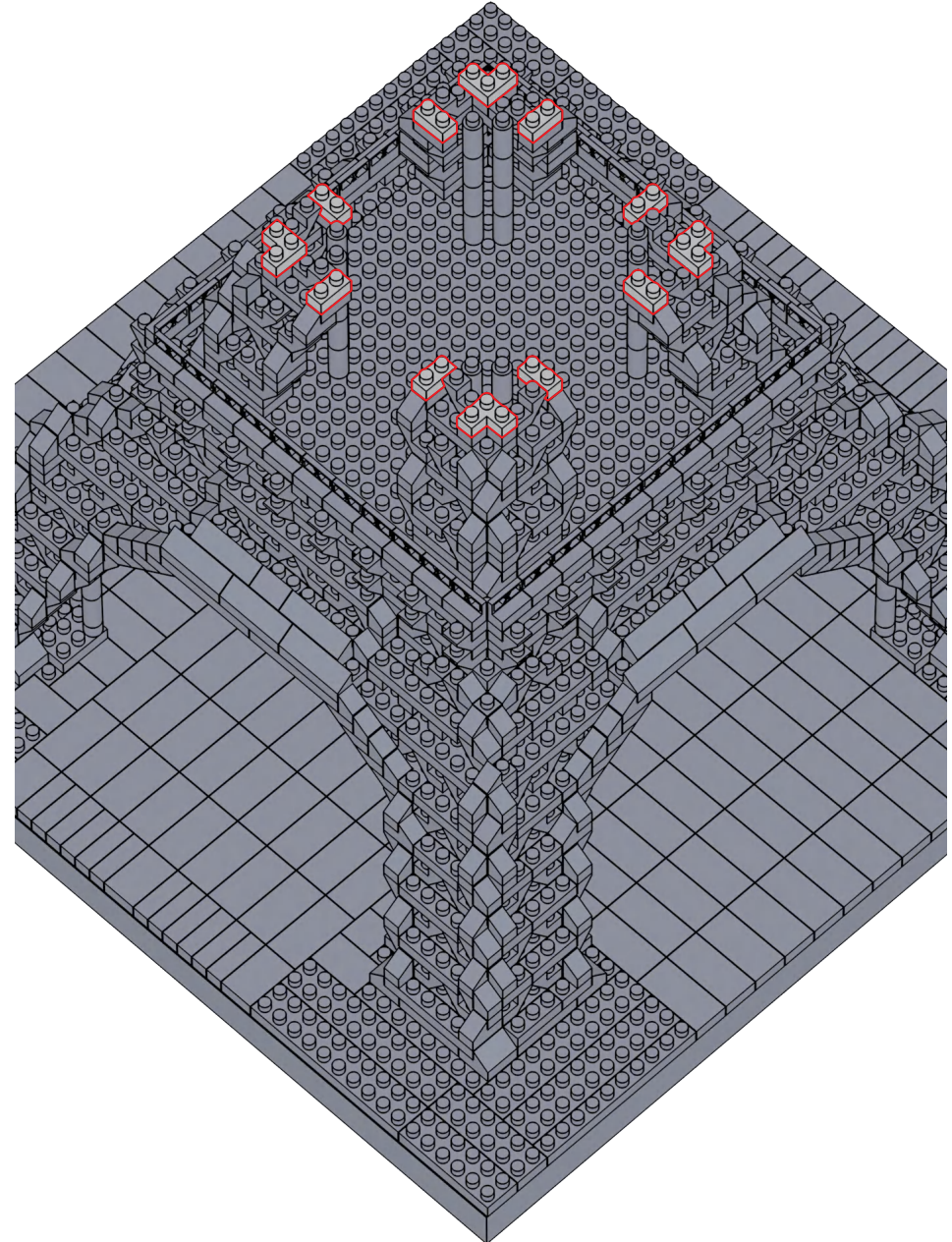

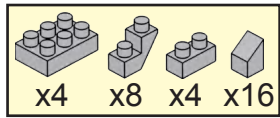

62

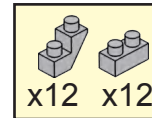
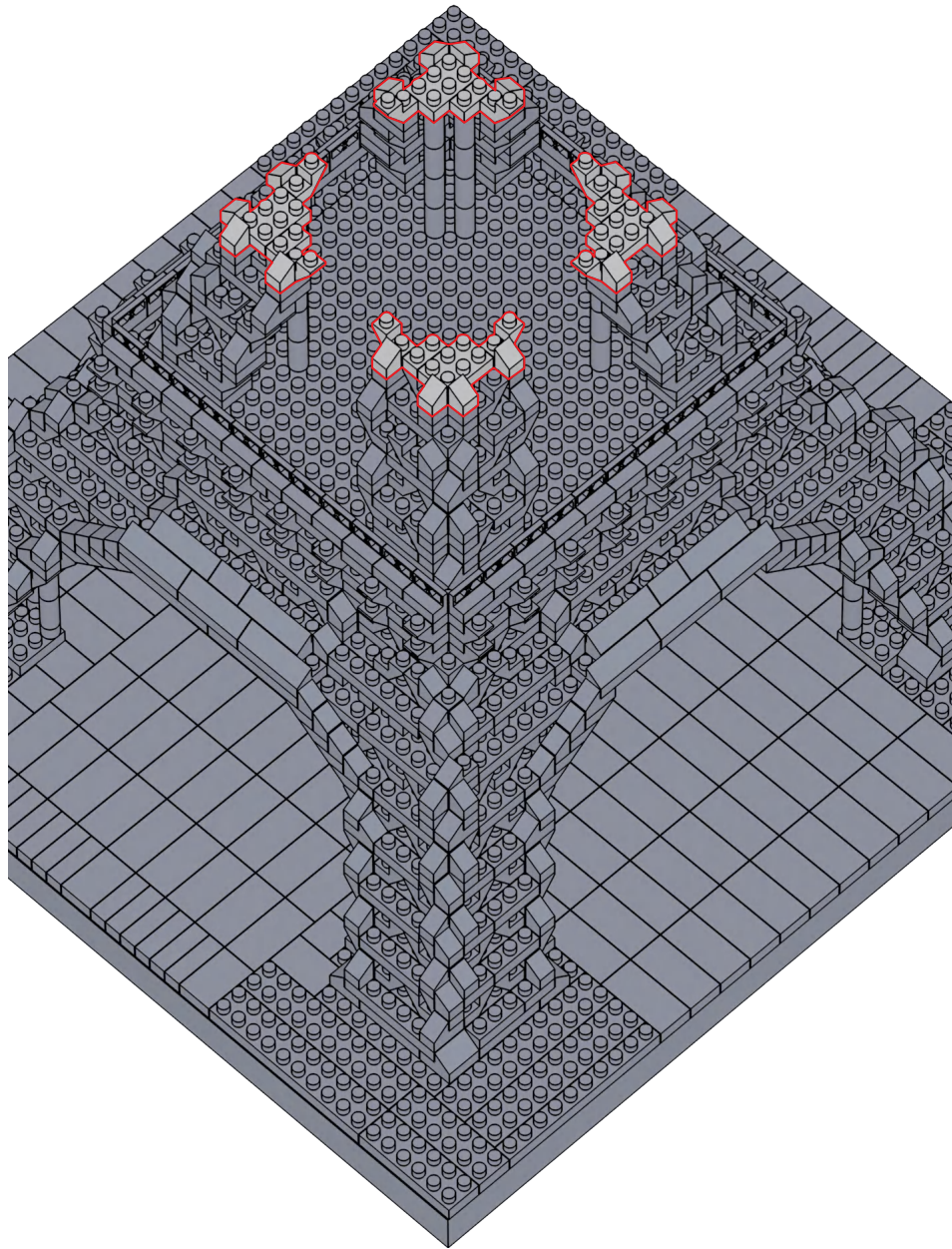

63

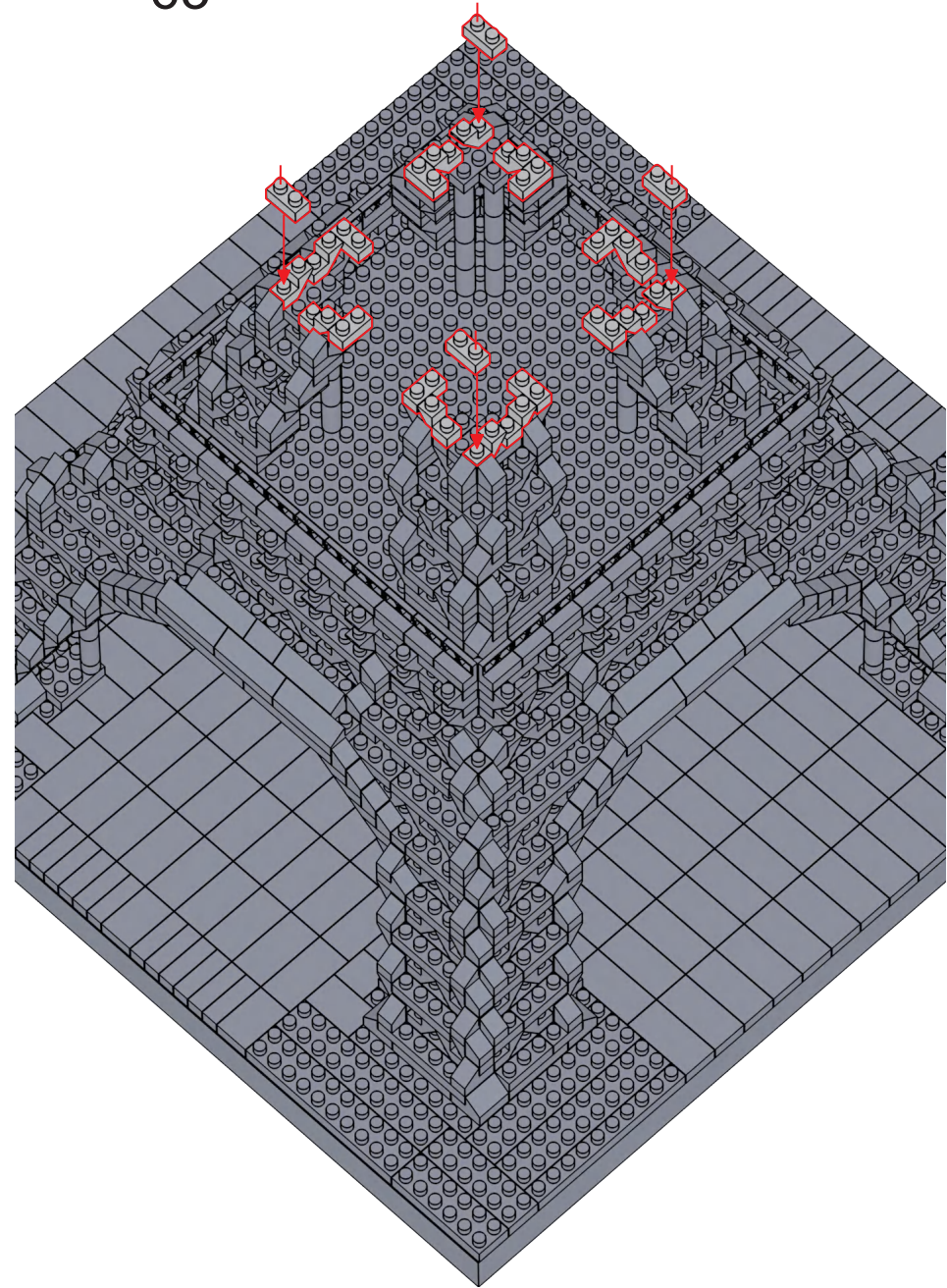

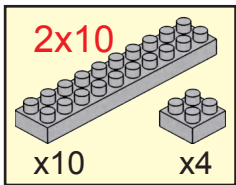

64

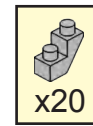
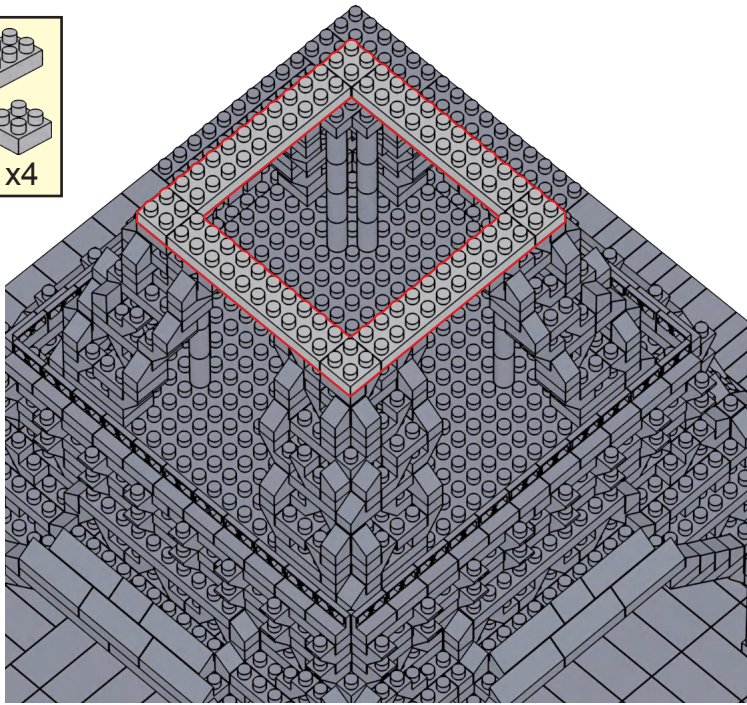

65

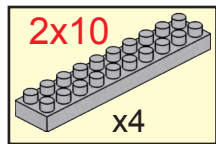
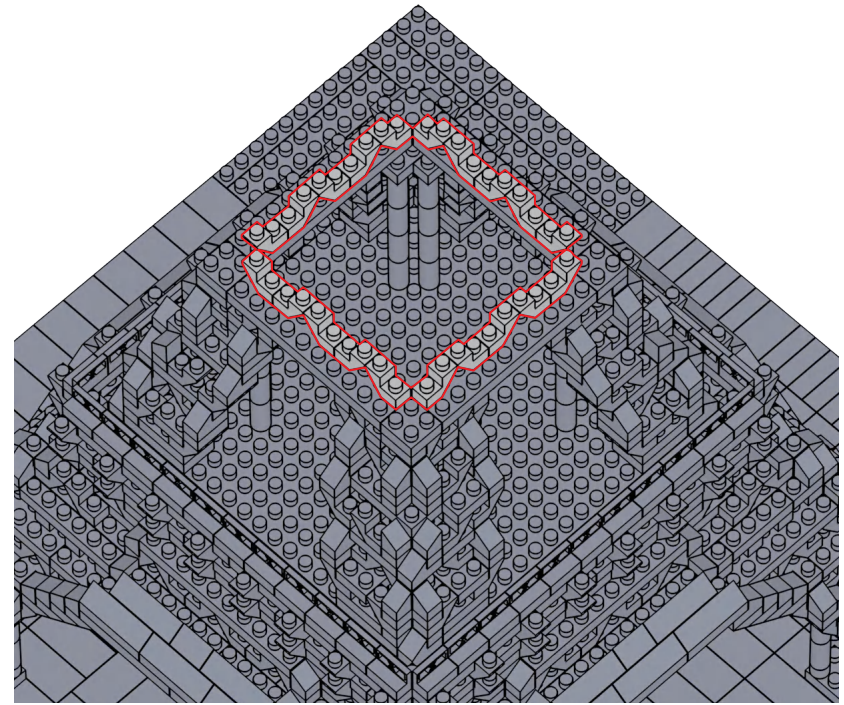

66

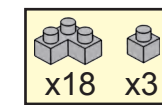
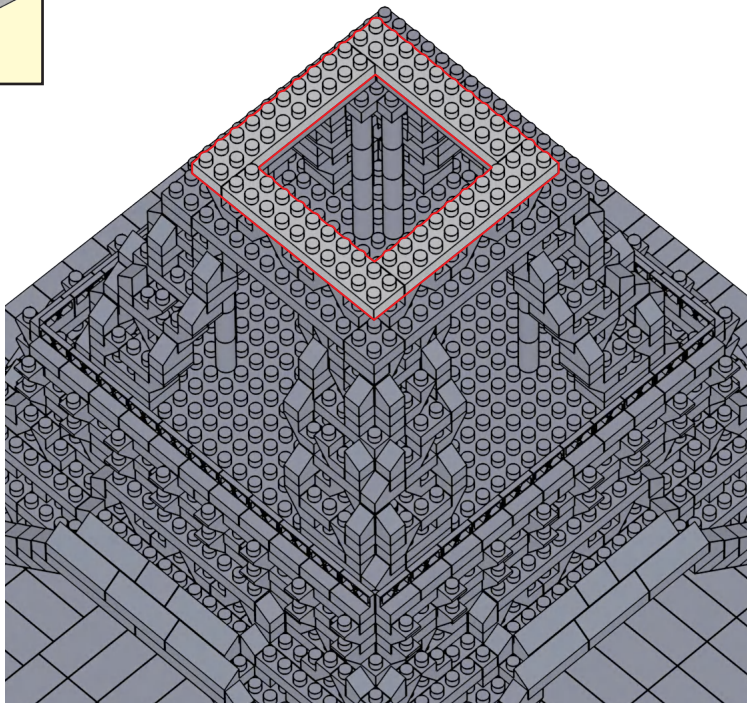

67

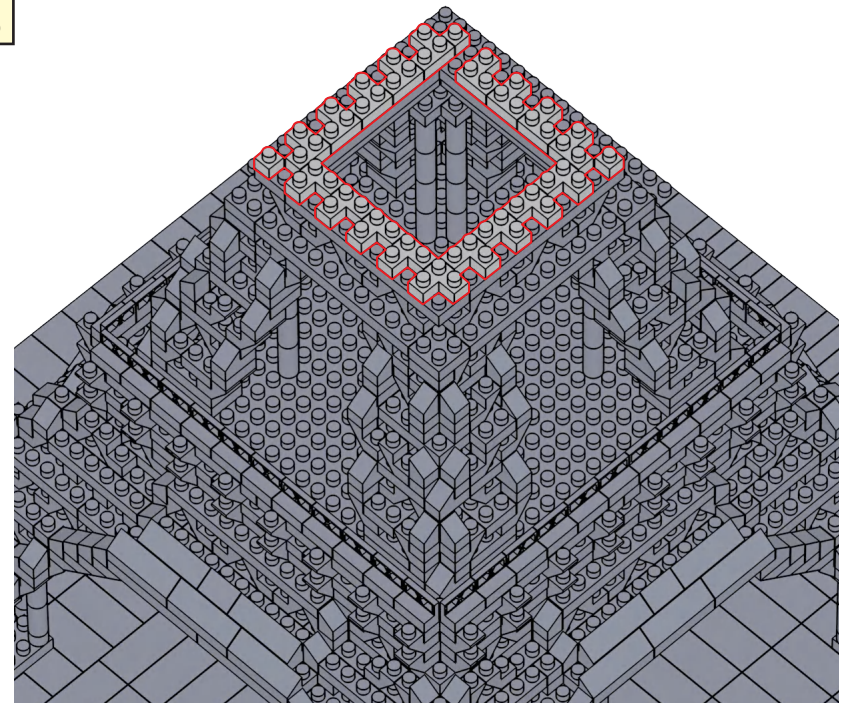

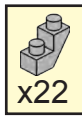

x22

68

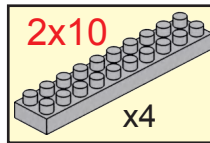
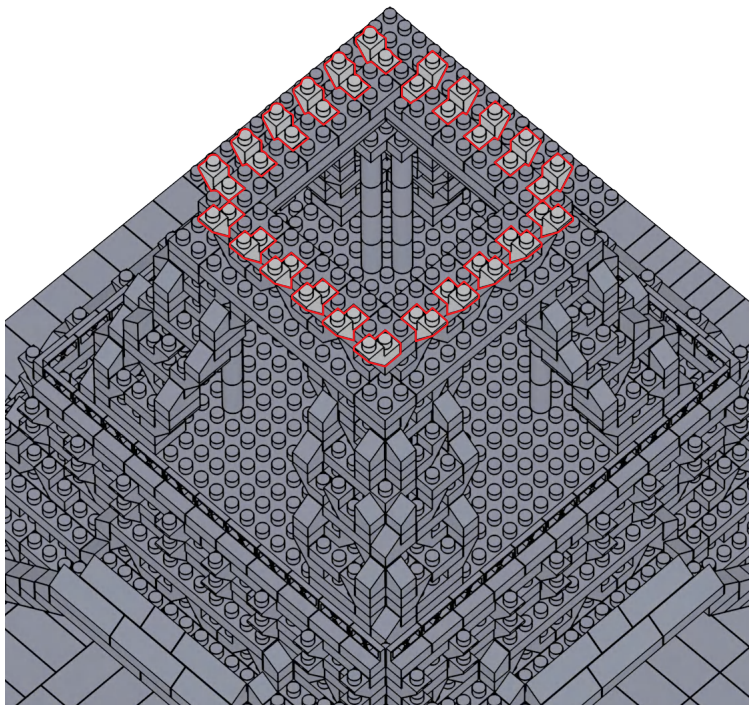

2x10

x4

69

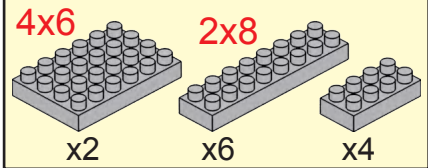
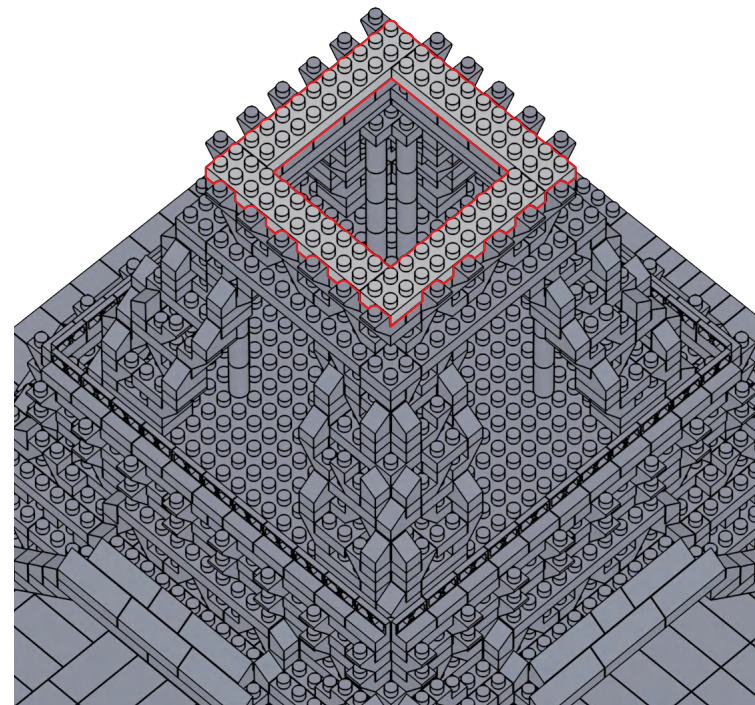

4x6

2x8

x2

x6

x4

70

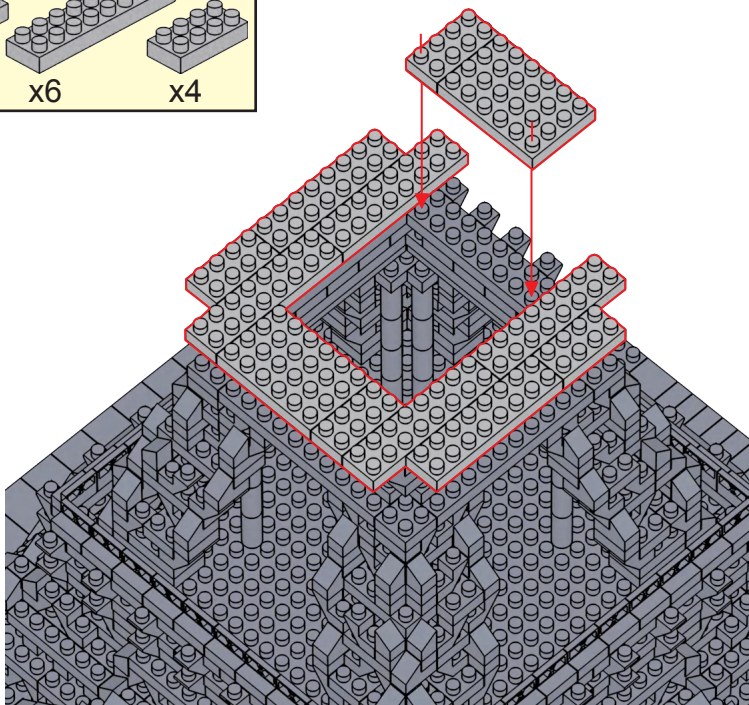

x30

71

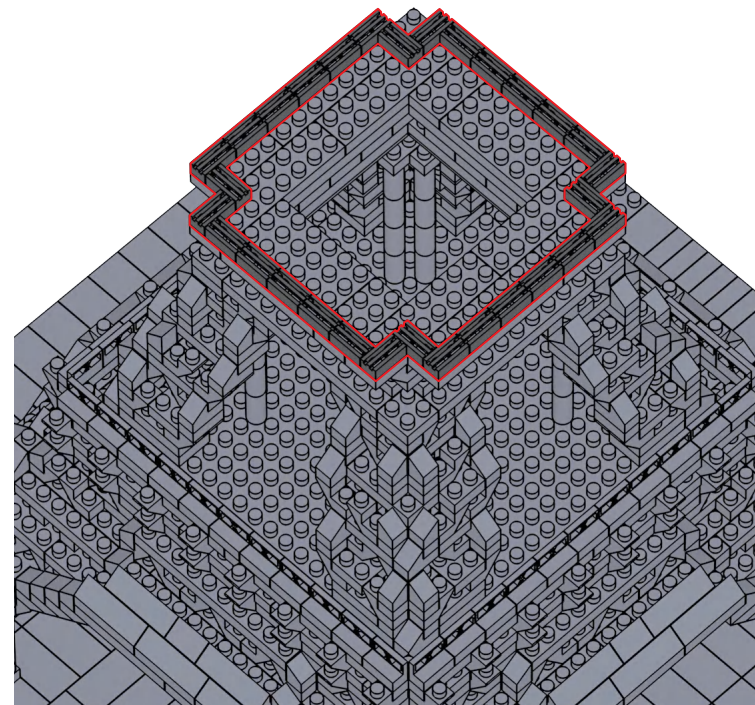

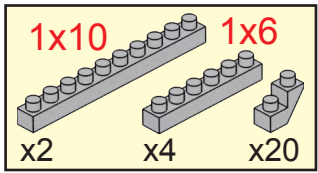

72

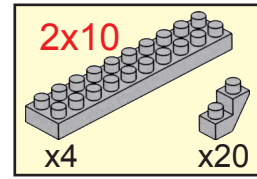
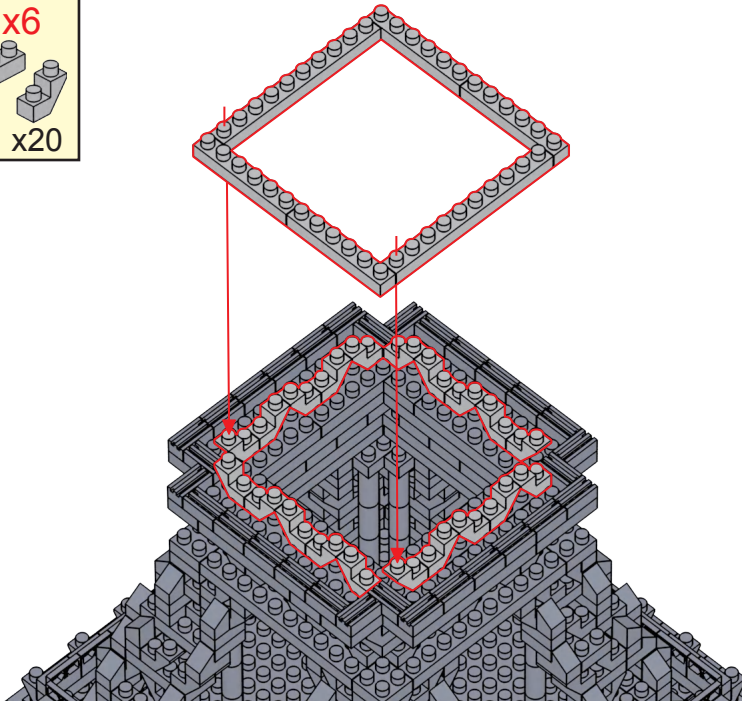

73

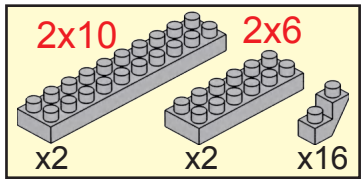
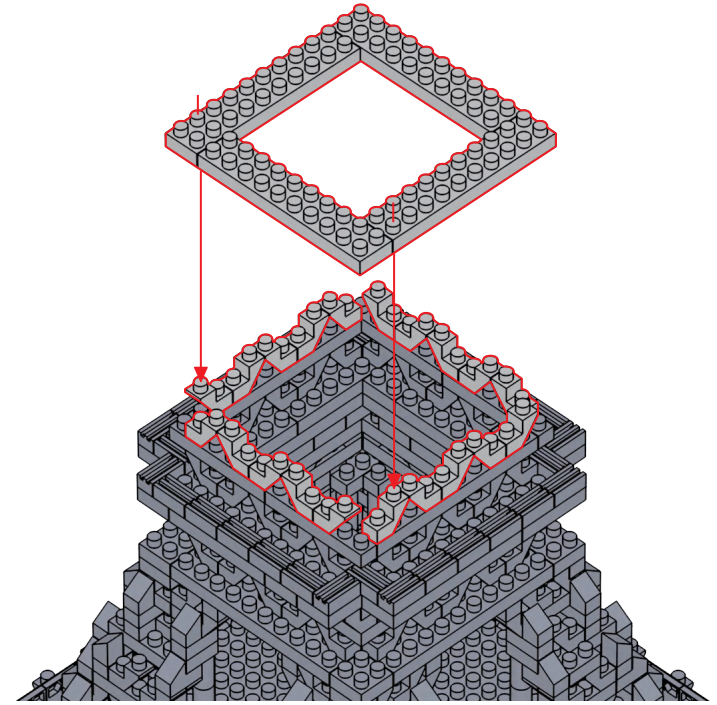

74

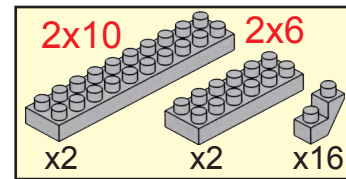
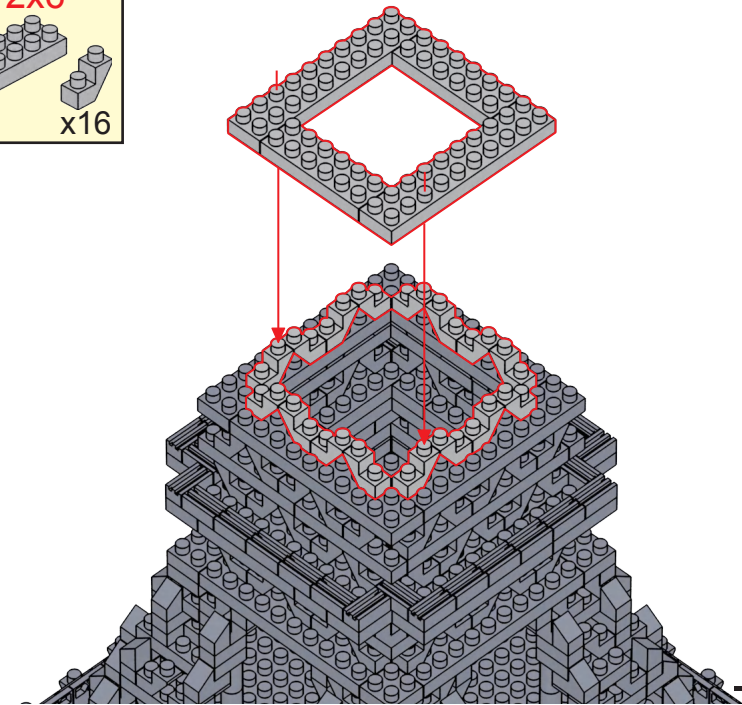

75

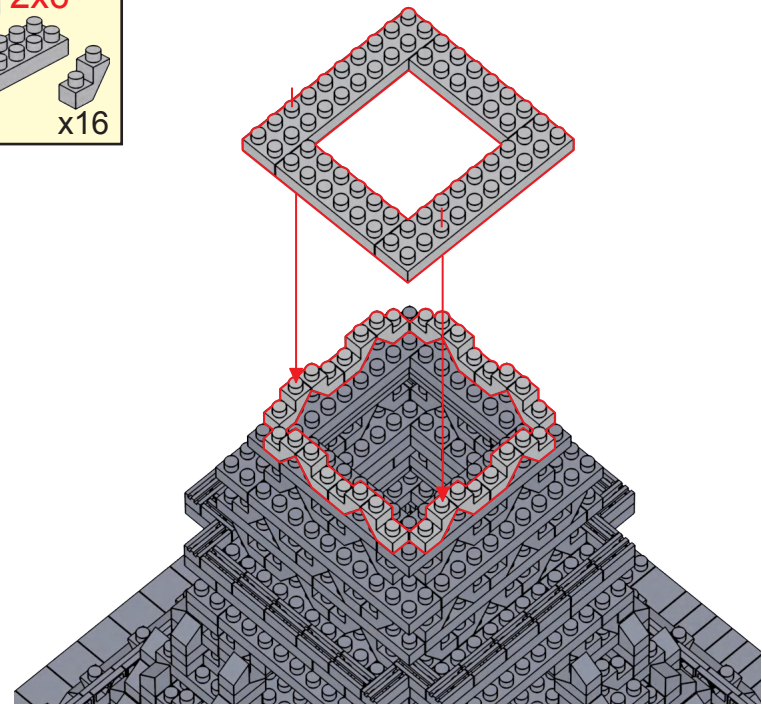

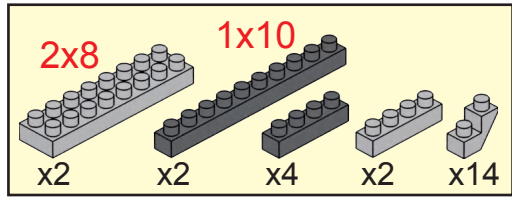

76

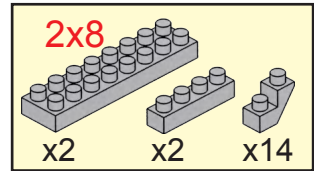
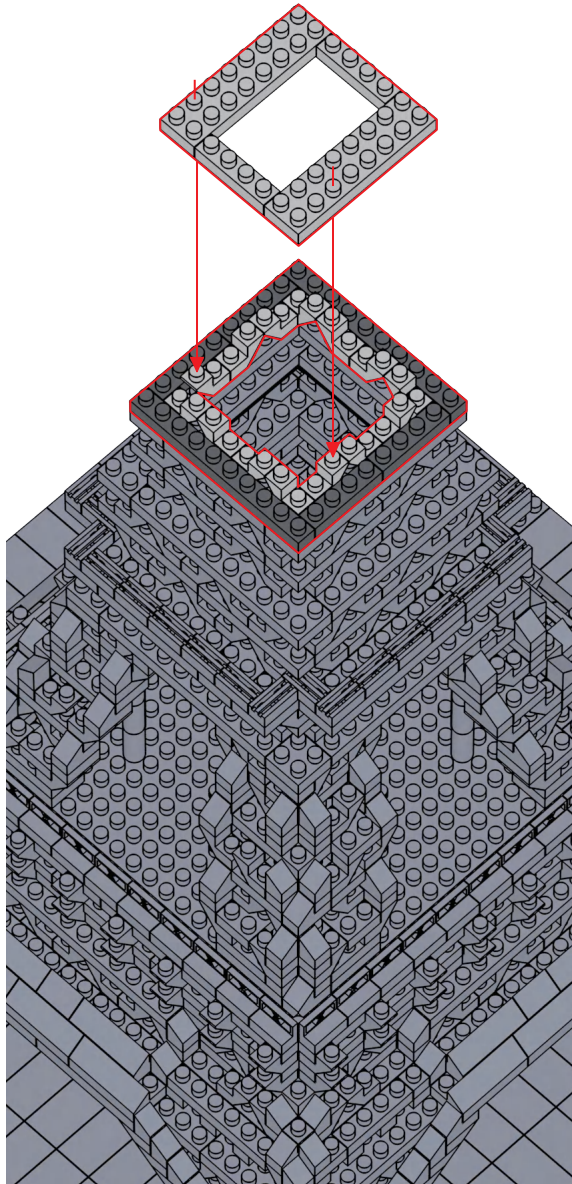

77

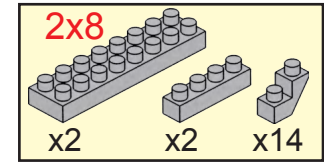
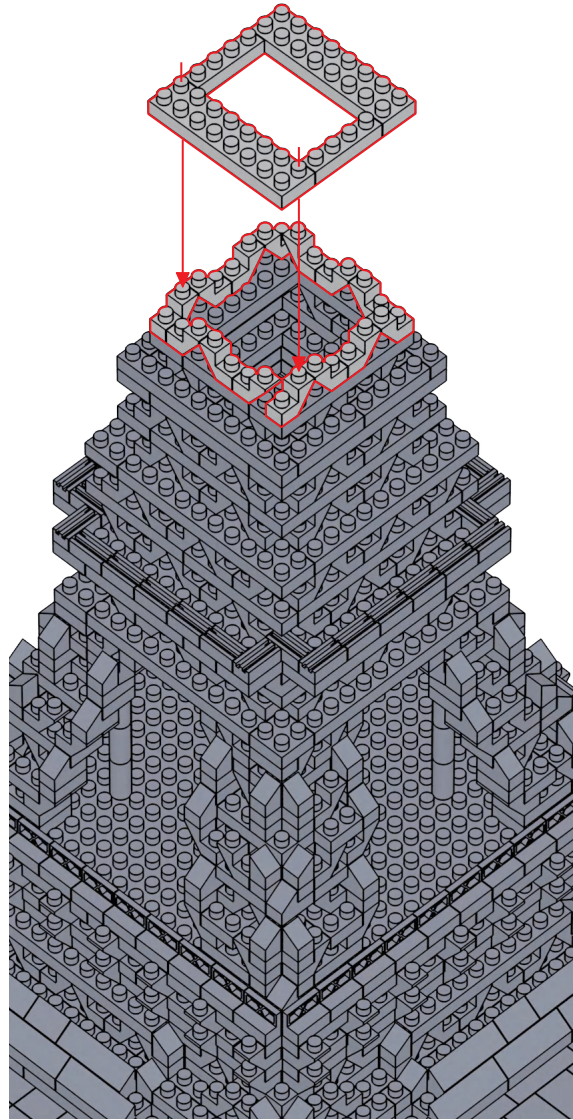

78

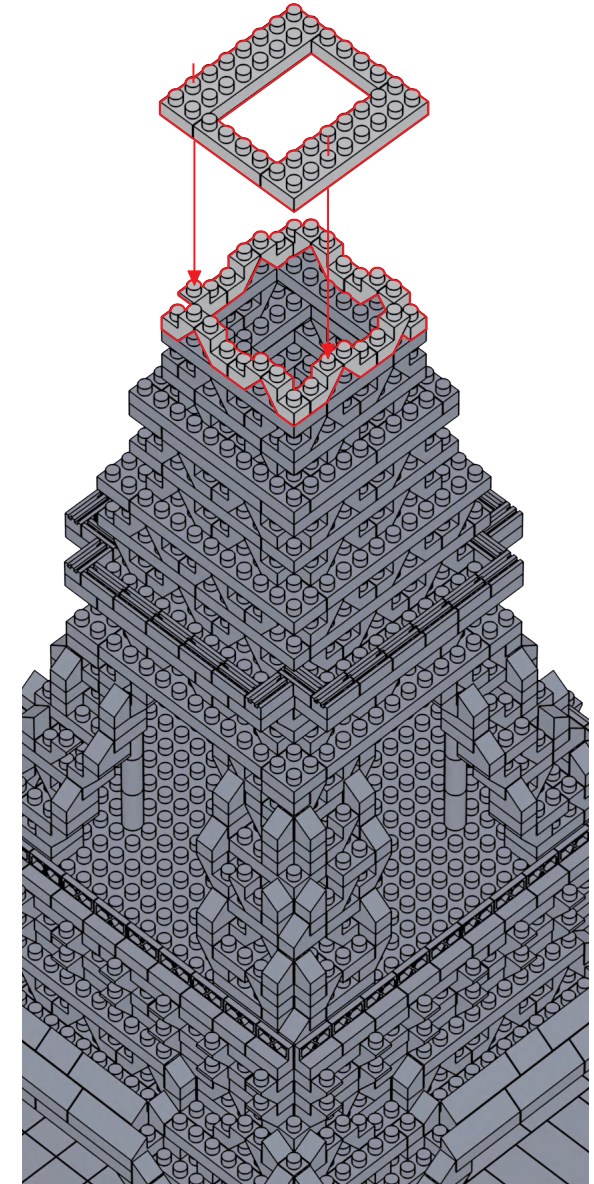

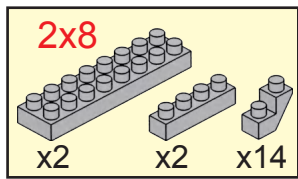

79

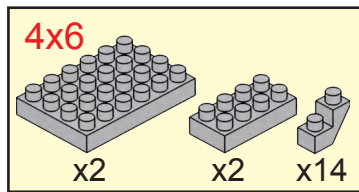
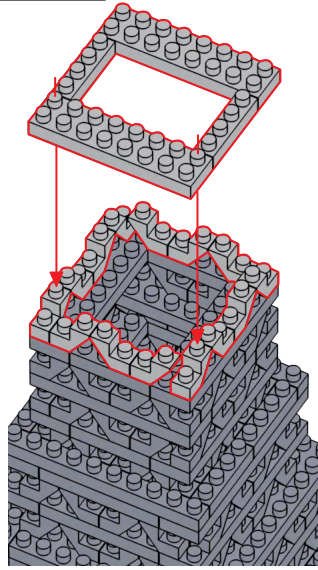

80

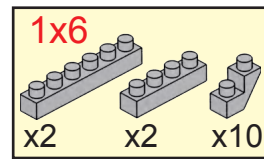
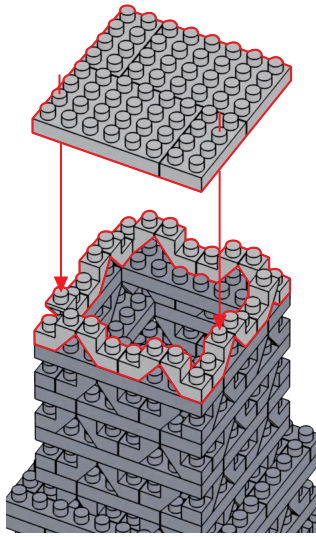

81

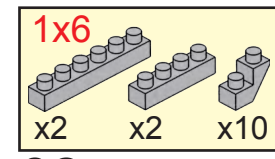
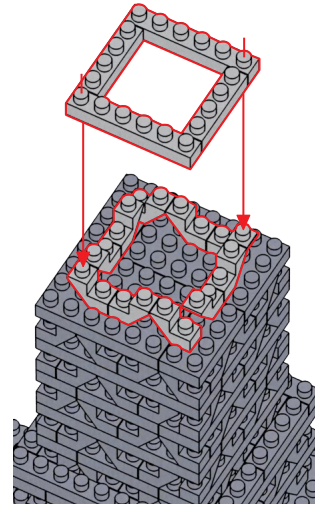

82

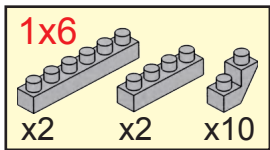
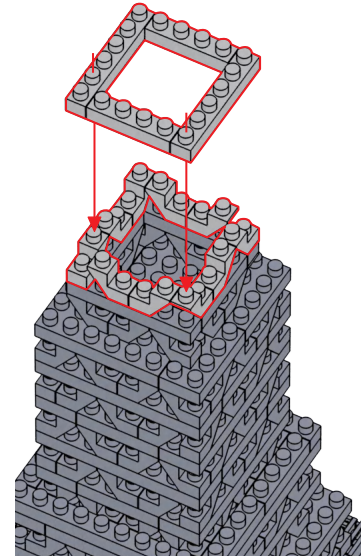

83

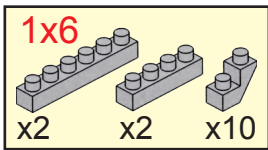
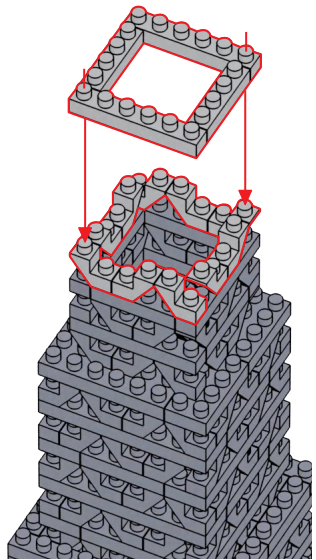

84

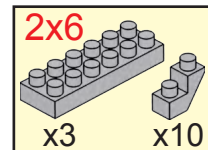
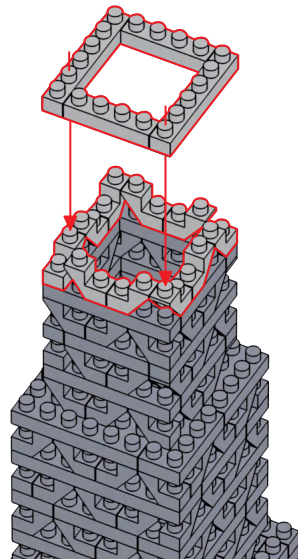

85

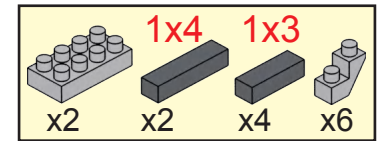
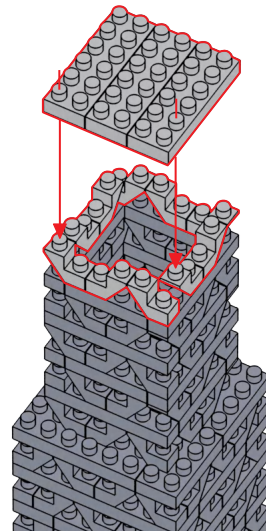

86

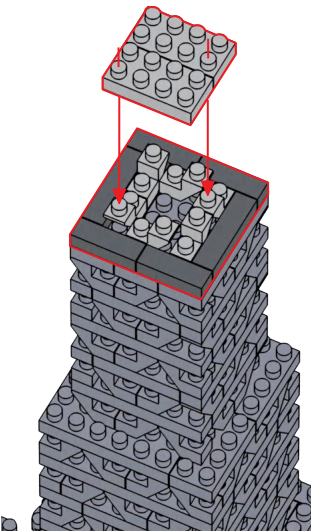

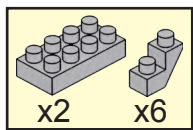

87

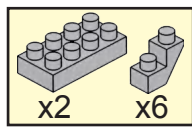
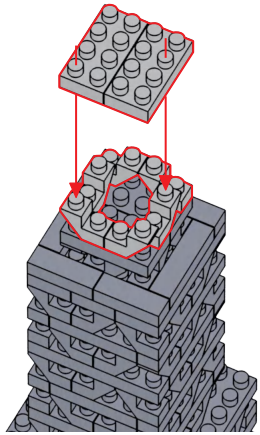

88

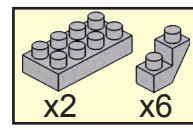
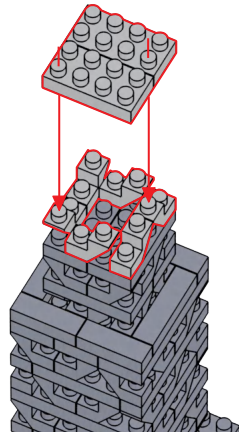

89

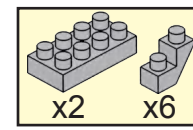
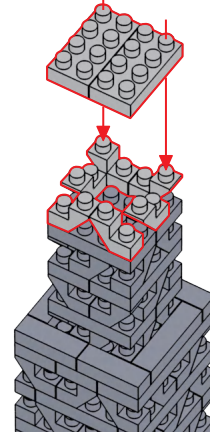

90

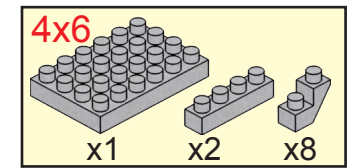
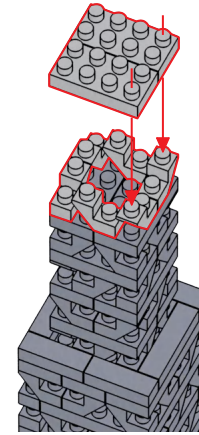

91

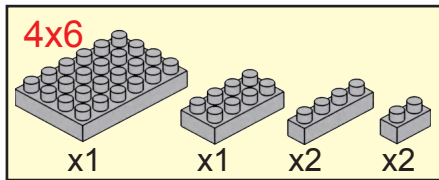
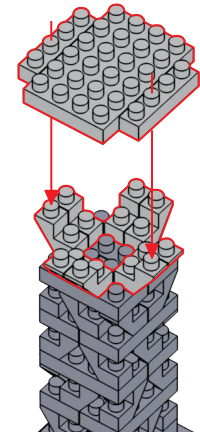

92

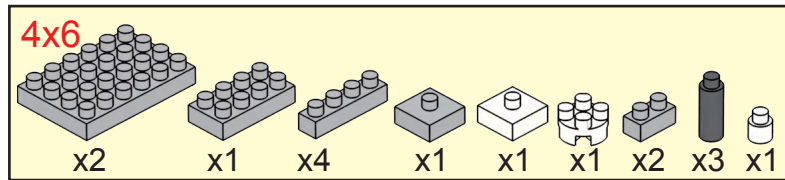
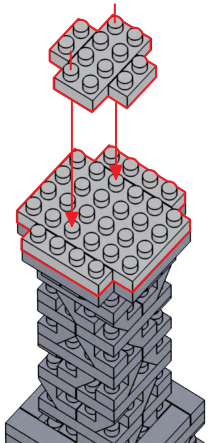

93

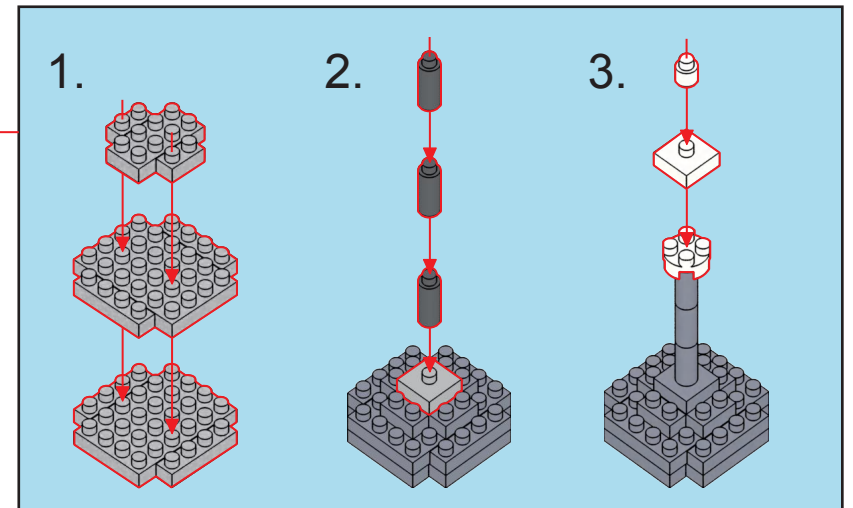
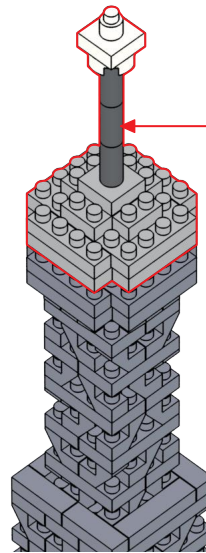

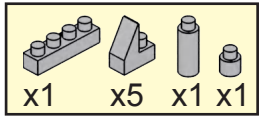

94

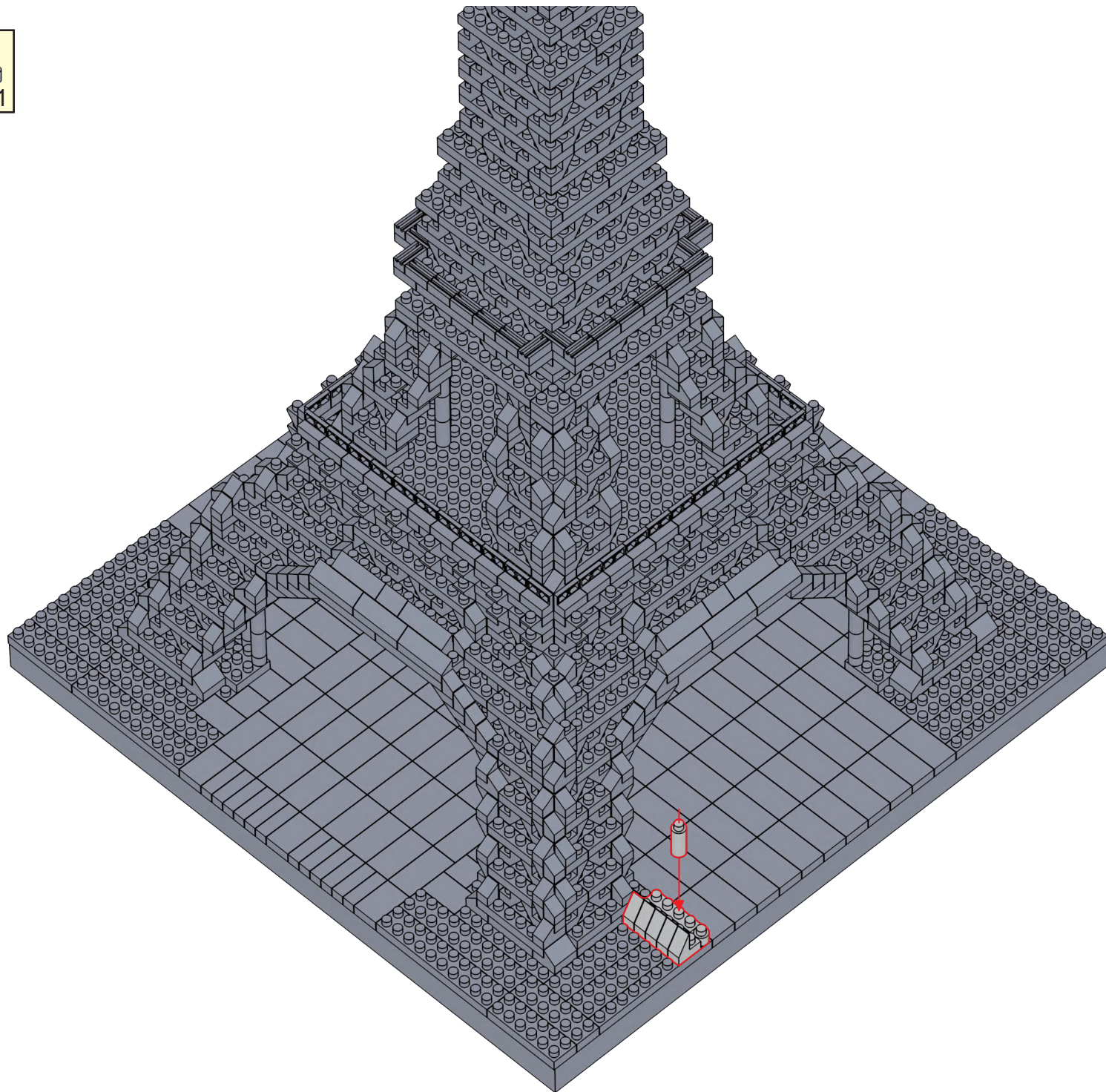

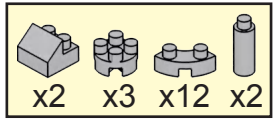

95

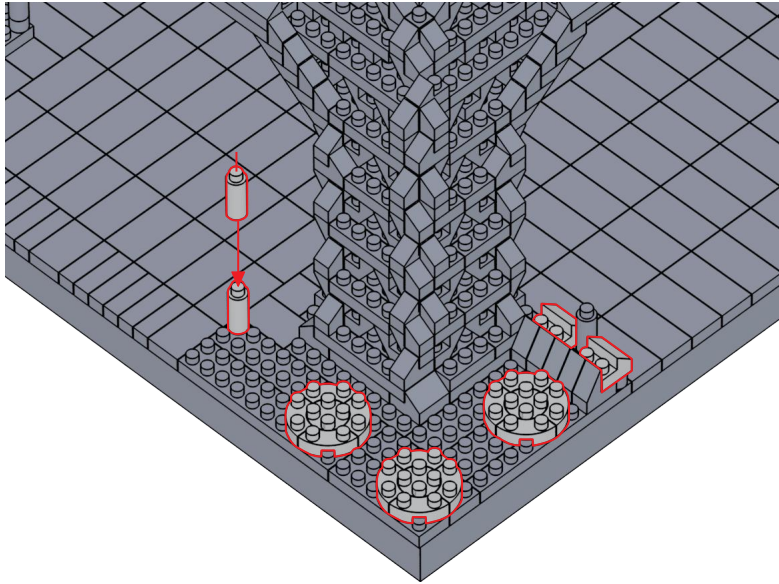

*  are transparent building blocks

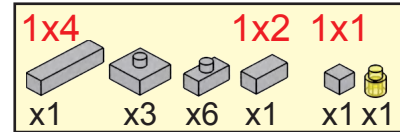

96

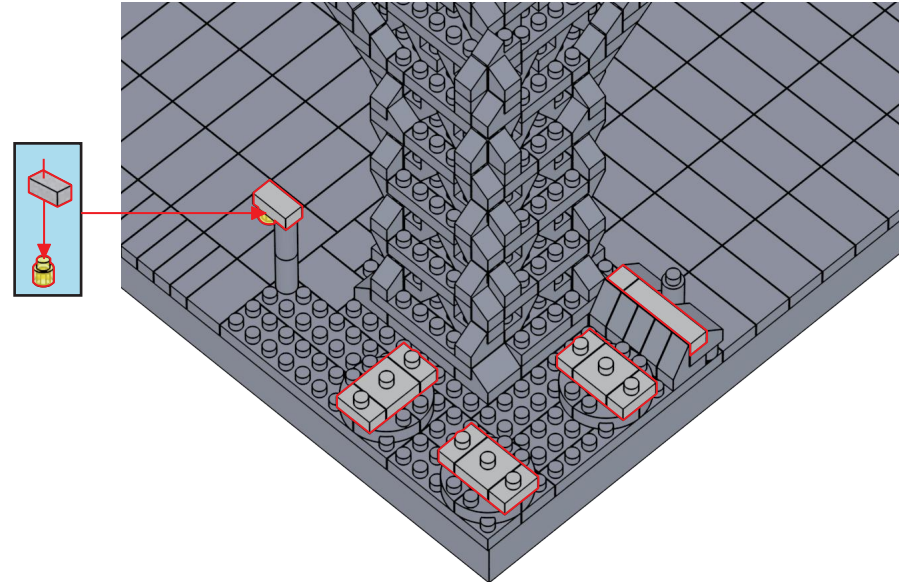

97

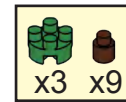
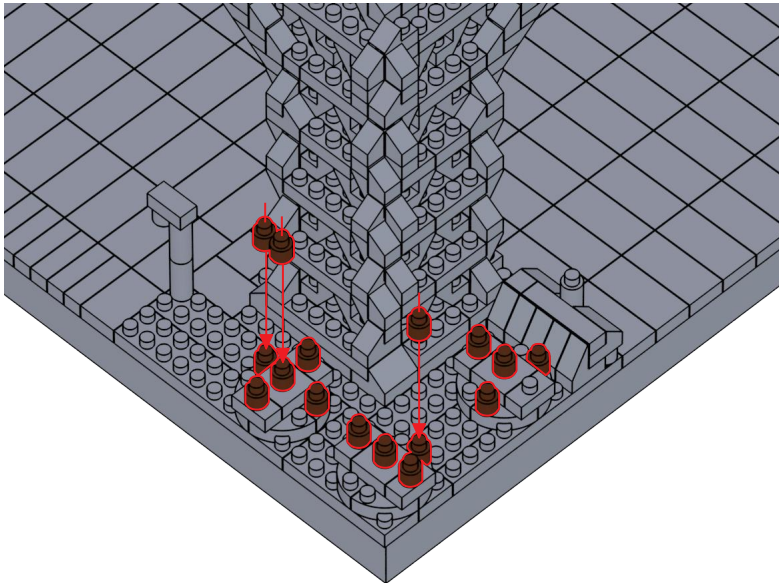

98

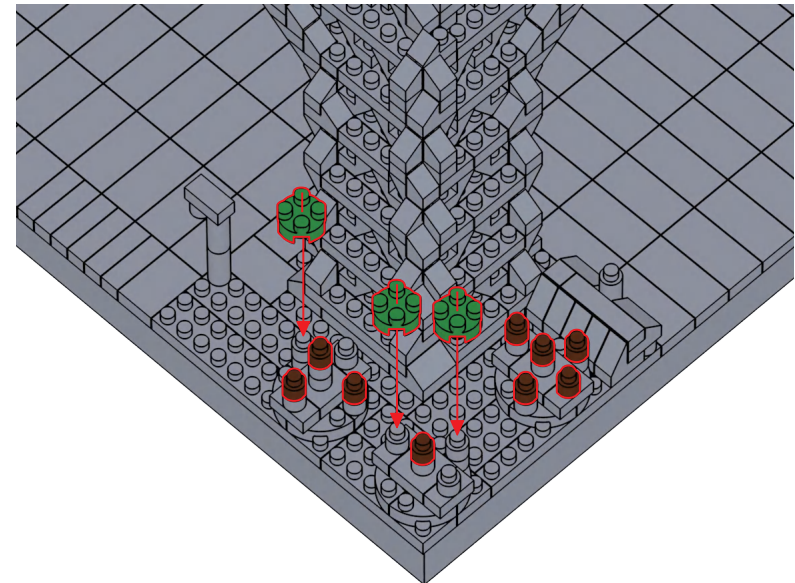

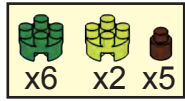

99

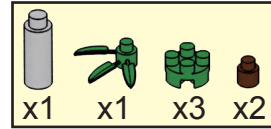
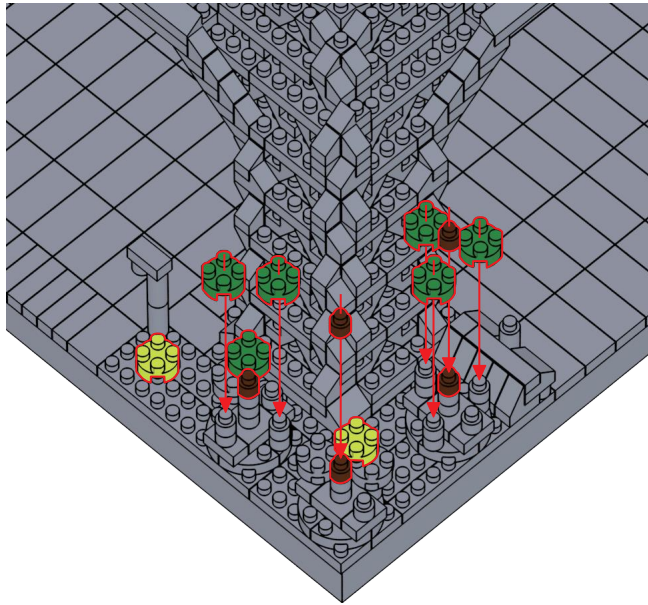

100

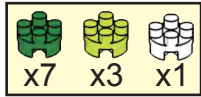
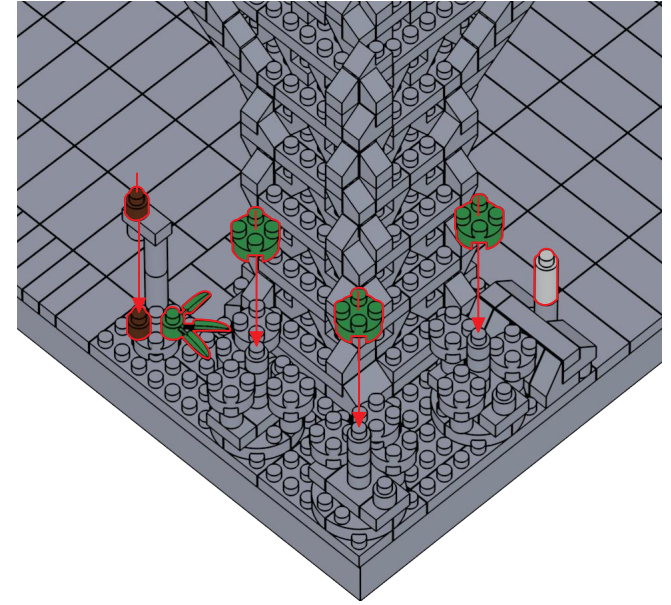

101

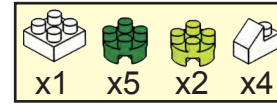
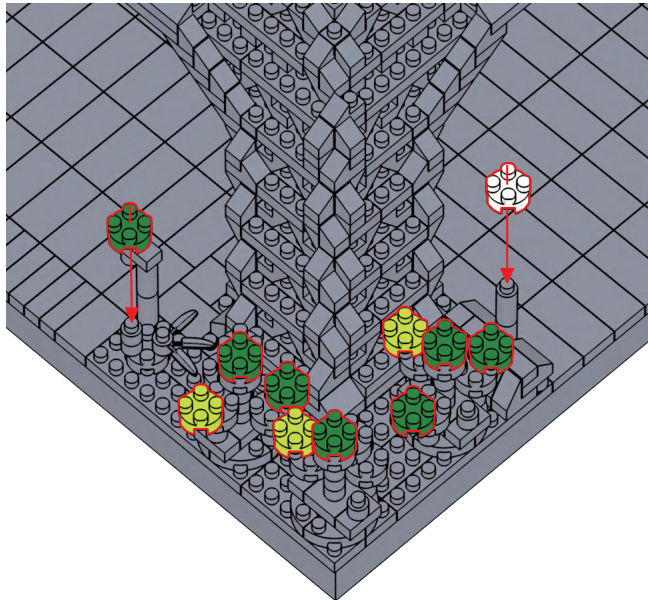

102

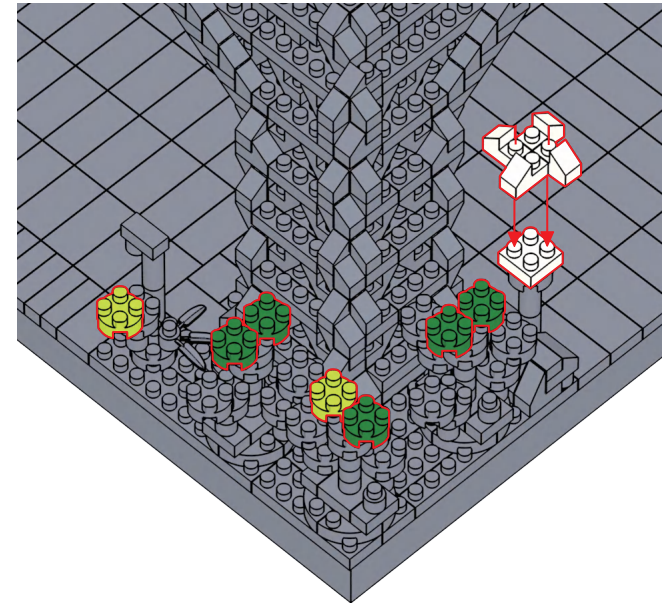

*  are transparent building blocks

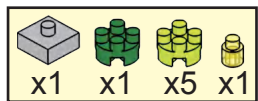

103

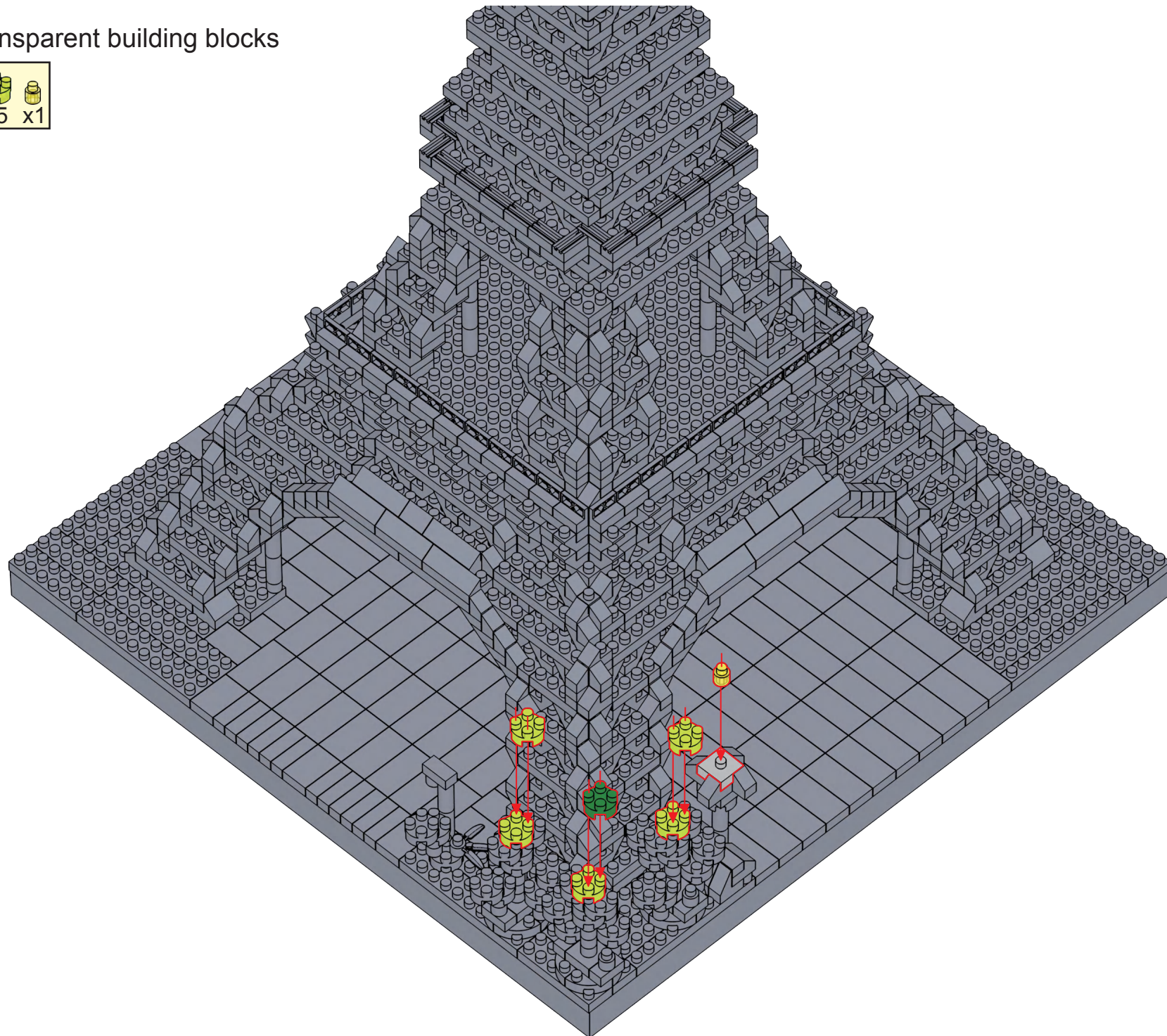

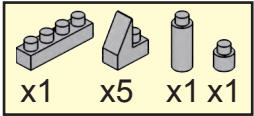

104

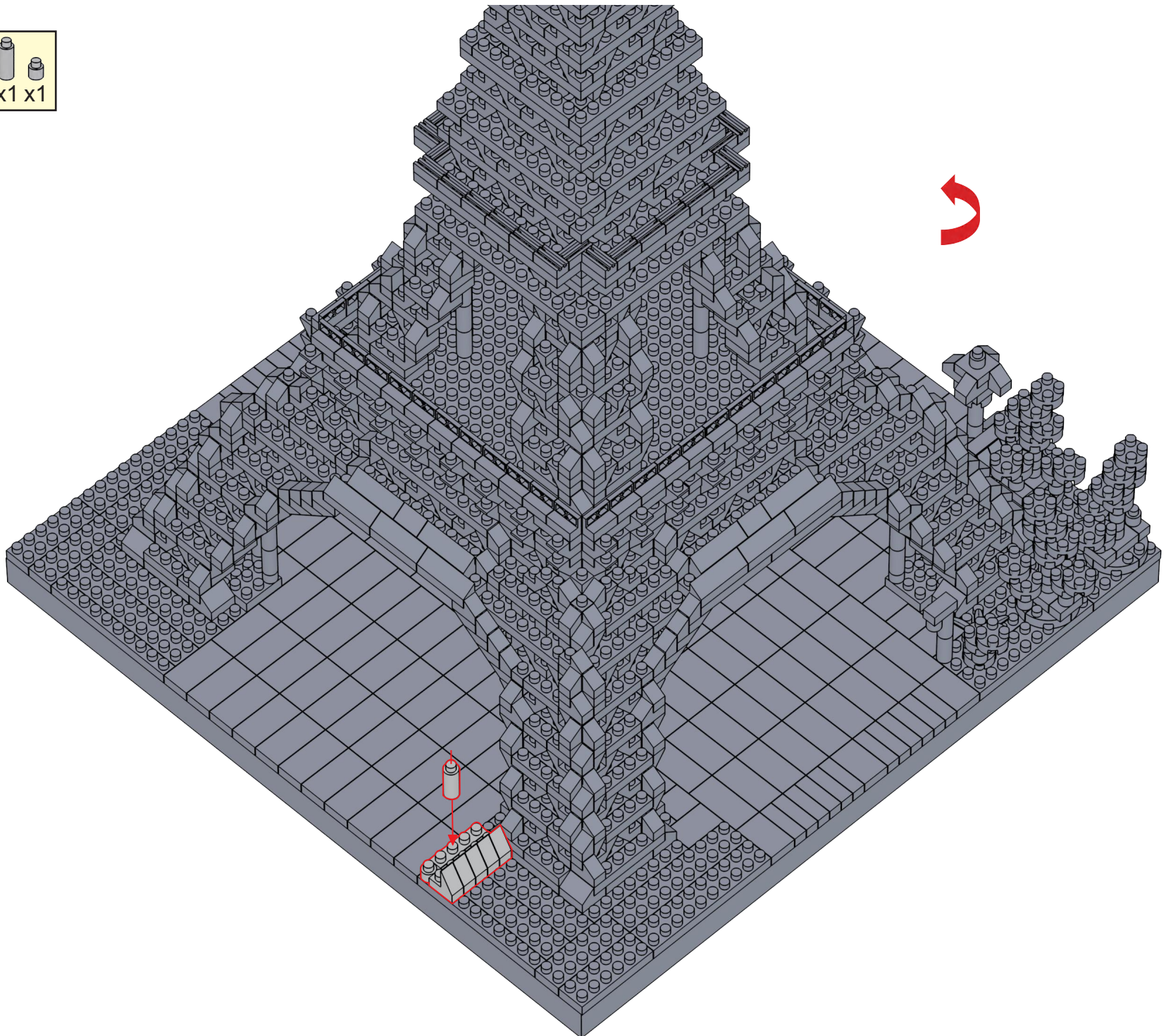

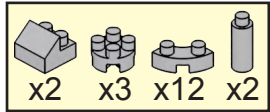

105

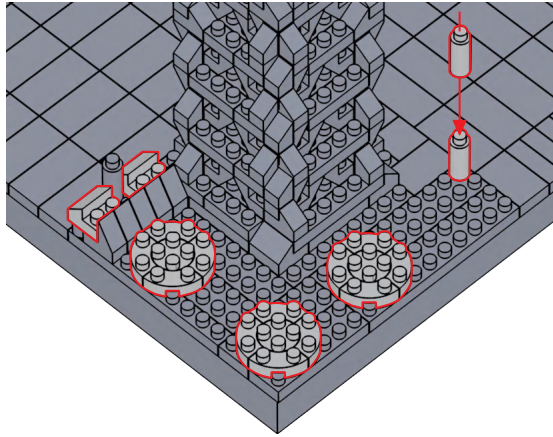

*  are transparent building blocks

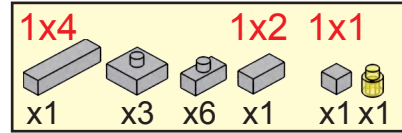

106

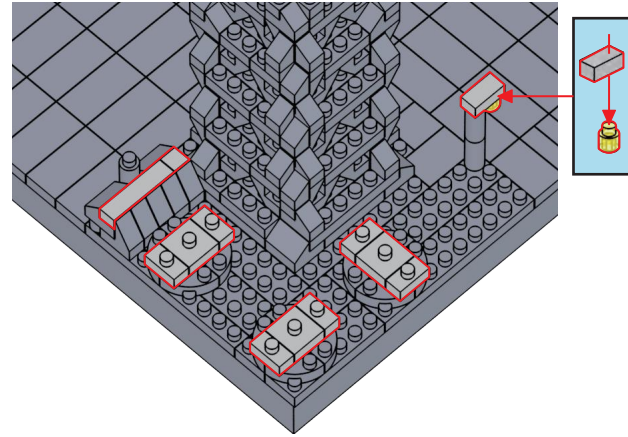

107

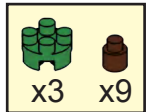
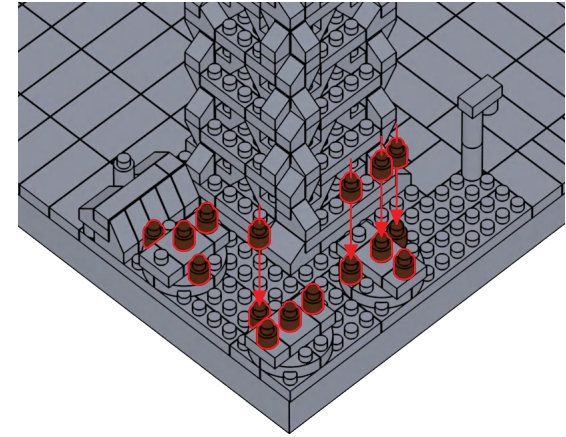

108

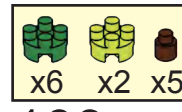
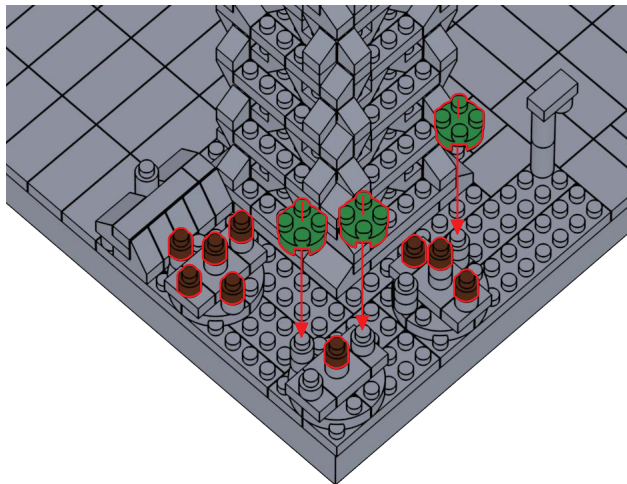

109

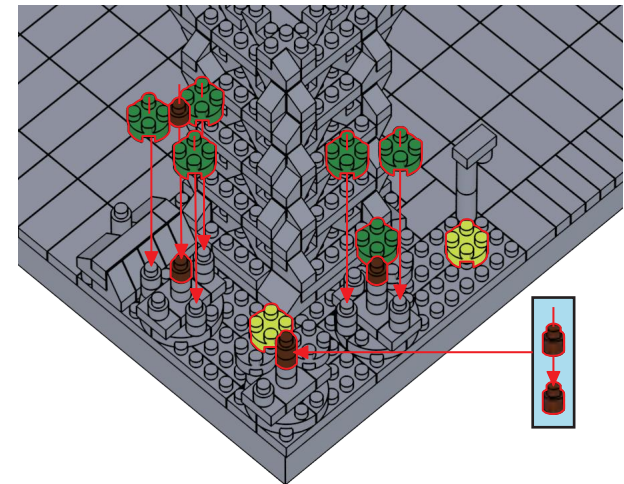

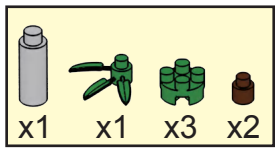

110

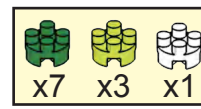
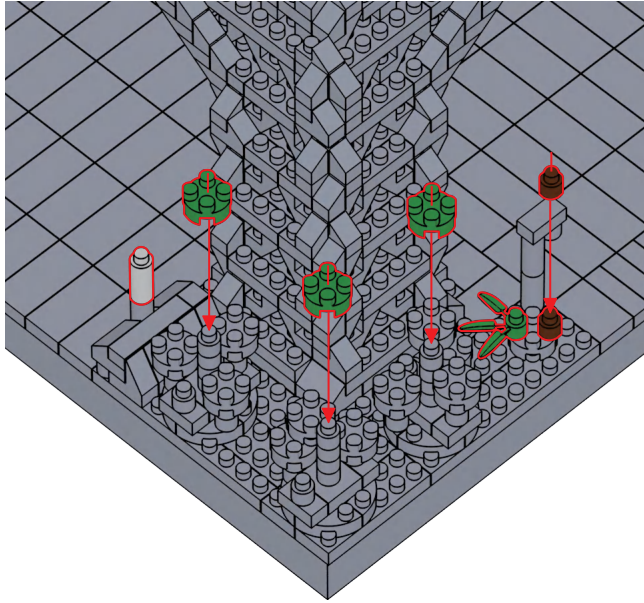

111

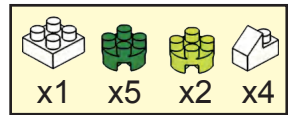
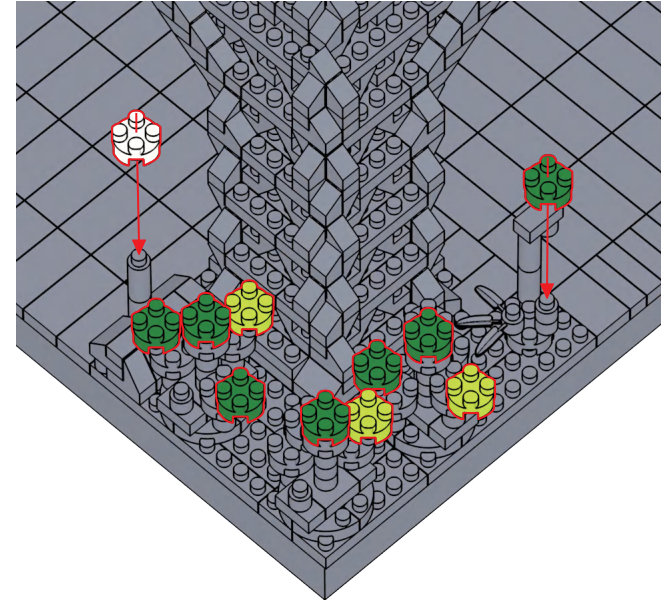

112

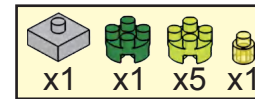
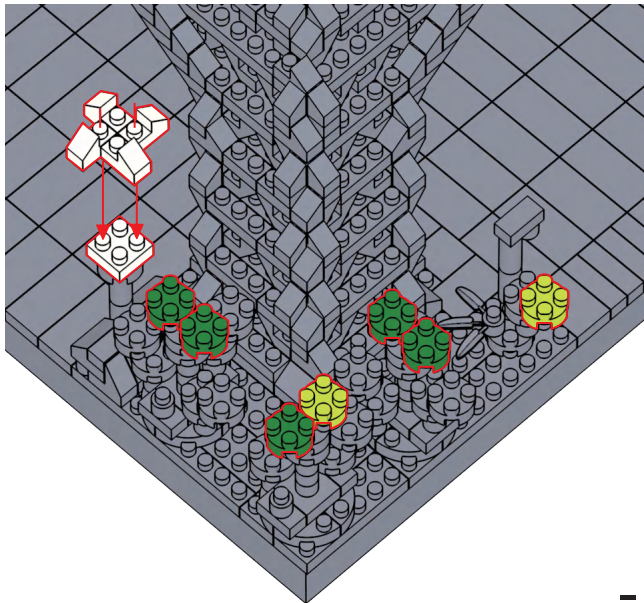

113

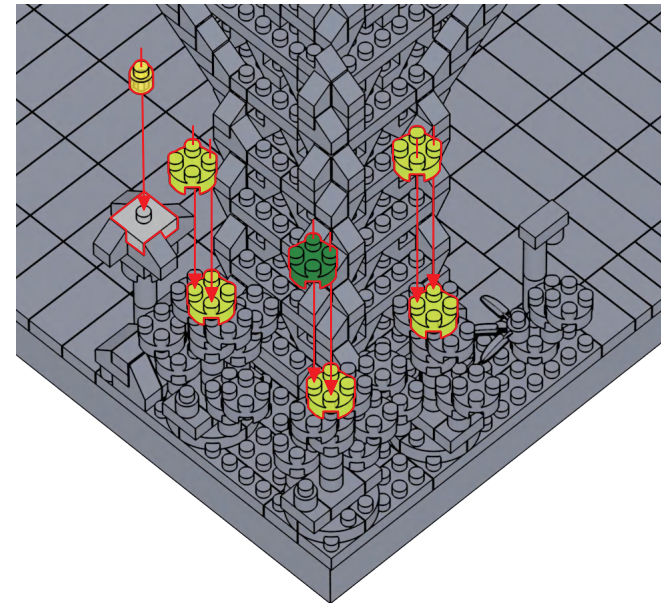

114

Repeat Step 107-116

Step 97-106

Step 107-116

Repeat Step 97-106

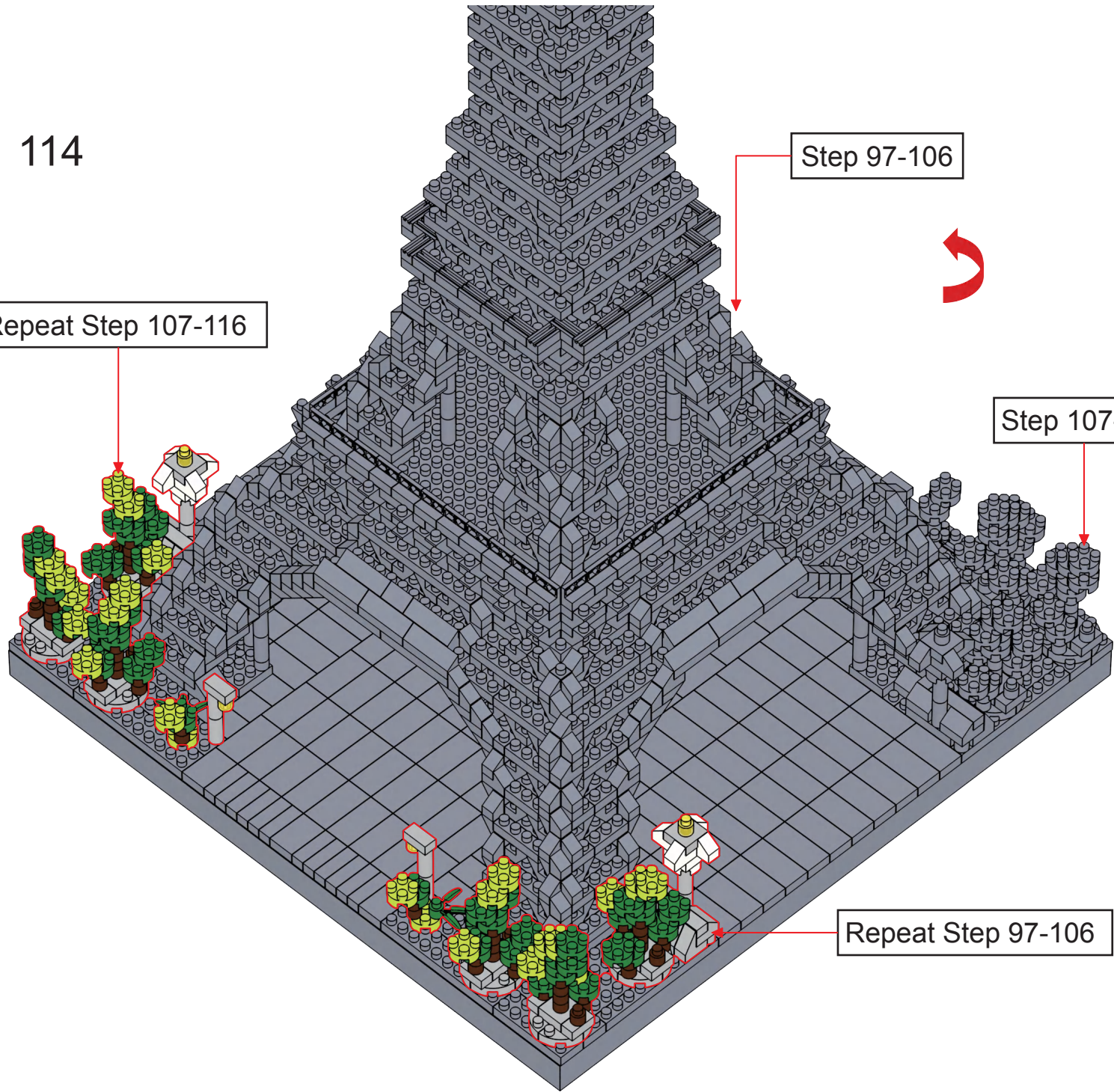



ADULT ASSISTANCE IS RECOMMENDED

 **WARNING:** CHOKING HAZARD
SMALL PARTS. NOT FOR CHILDREN UNDER 3 YEARS.