

Assembly Instructions

K: 43472444 | T: 70205947 LARGE HAMPTONS PLANTER





CARE INSTRUCTIONS:

WIPE CLEAN WITH A SOFT DAMP CLOTH. DO NOT USE ABRASIVE MATERIAL AND SOLVENTS. CHECK AND TIGHTEN ALL PARTS REGULARLY.

WARNING:

DO NOT STAND ON THE UNIT. USE ONLY ON A FLAT SURFACE. DO NOT USE UNTIL ALL SCREWS, BOLTS AND KNOBS ARE FIRMLY SECURED. THIS PRODUCT CONTAINS SMALL PARTS AND SHARP POINTS, KEEP AWAY FROM CHILDREN AND BABIES. ADULT ASSEMBLY REQUIRED. FAILURE TO FOLLOW THESE WARNINGS COULD RESULT IN SERIOUS INJURY. **MAXIMUM SAFE LOAD: 30 KG FOR SHELF, ENSURE THERE IS A SAUCER AT THE BOTTOM IF PUT A REAL PLANT INTO THE PRODUCT.**

1 Hardware List

A		8pcs		B		8pcs		C		8pcs	
D		4pcs									

2 Parts List

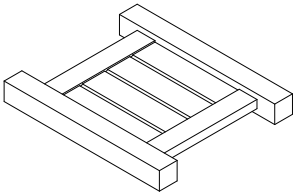
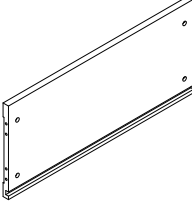
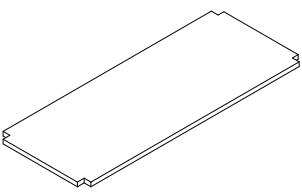
					
①	2pcs	②	2pcs	③	1pc

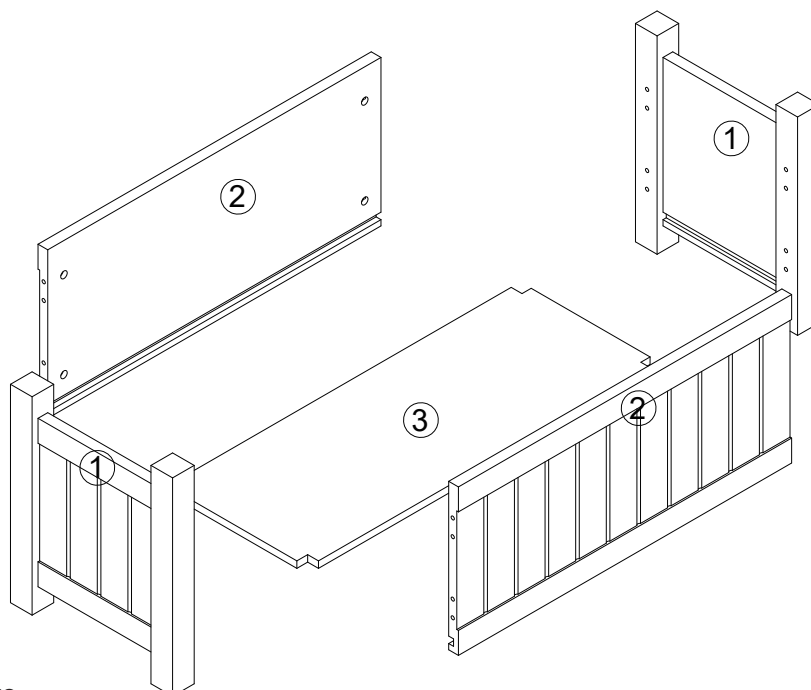

Do not tighten the screws fully during assembly. Fully tighten screws after the final assembly steps.

STEP 1 A -  x 4 B -  x 4 C -  x 4

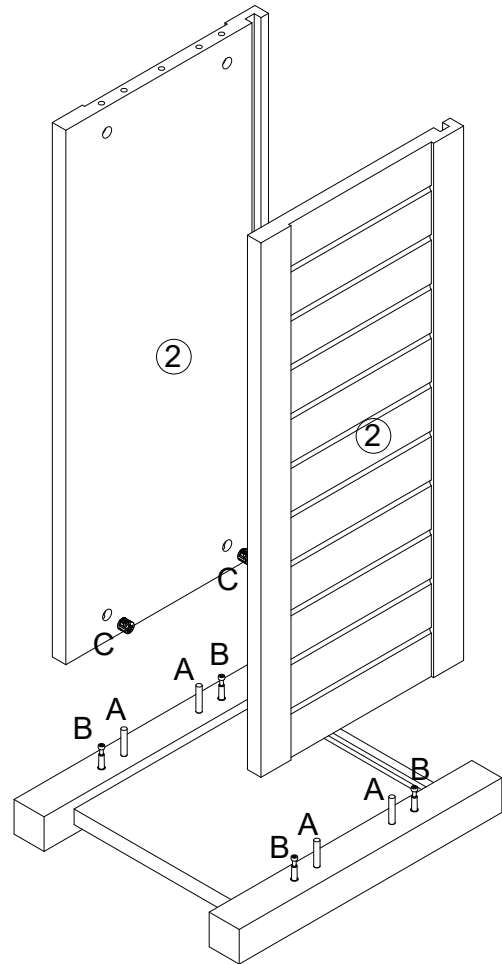
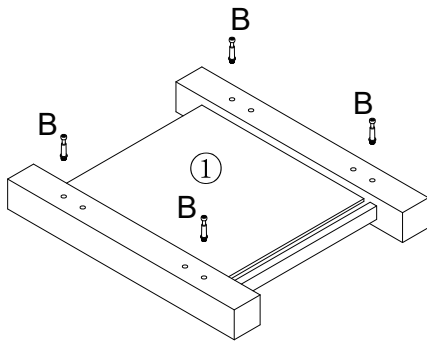

STEP 2

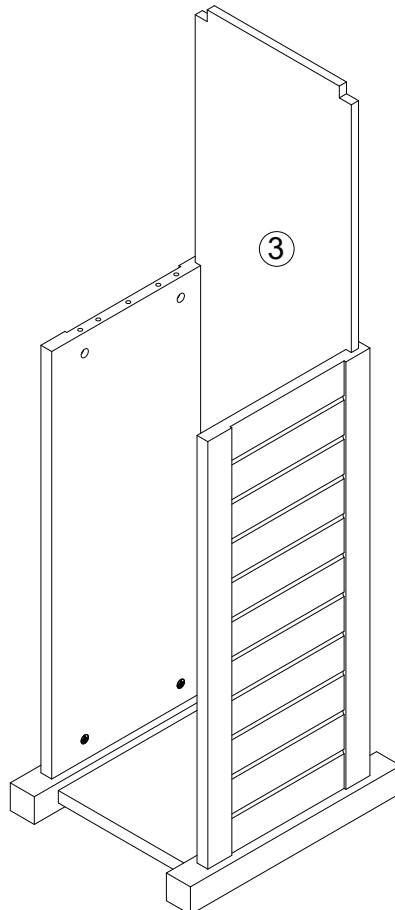

STEP 3 A -  x4 B -  x4 C -  x4

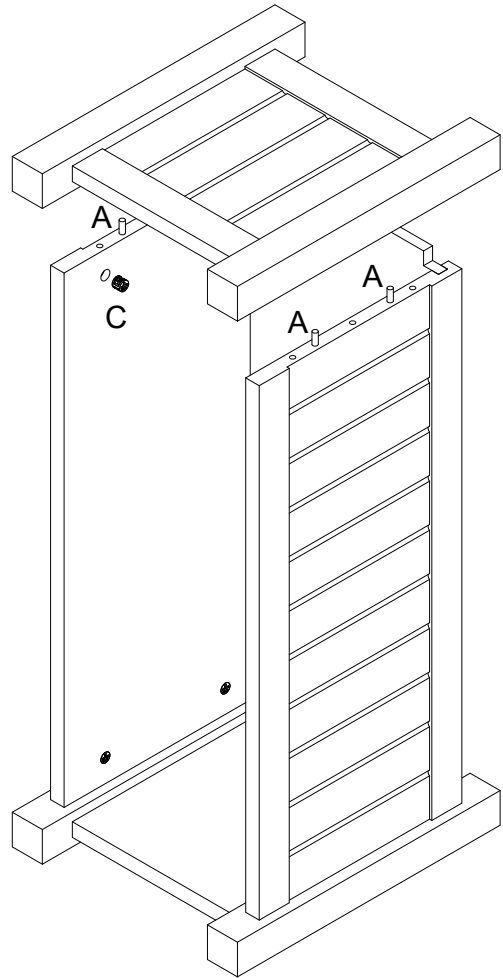
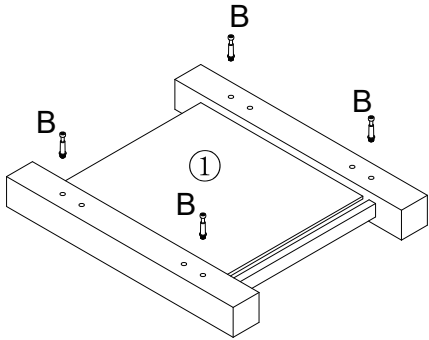

STEP 4 D -  x4

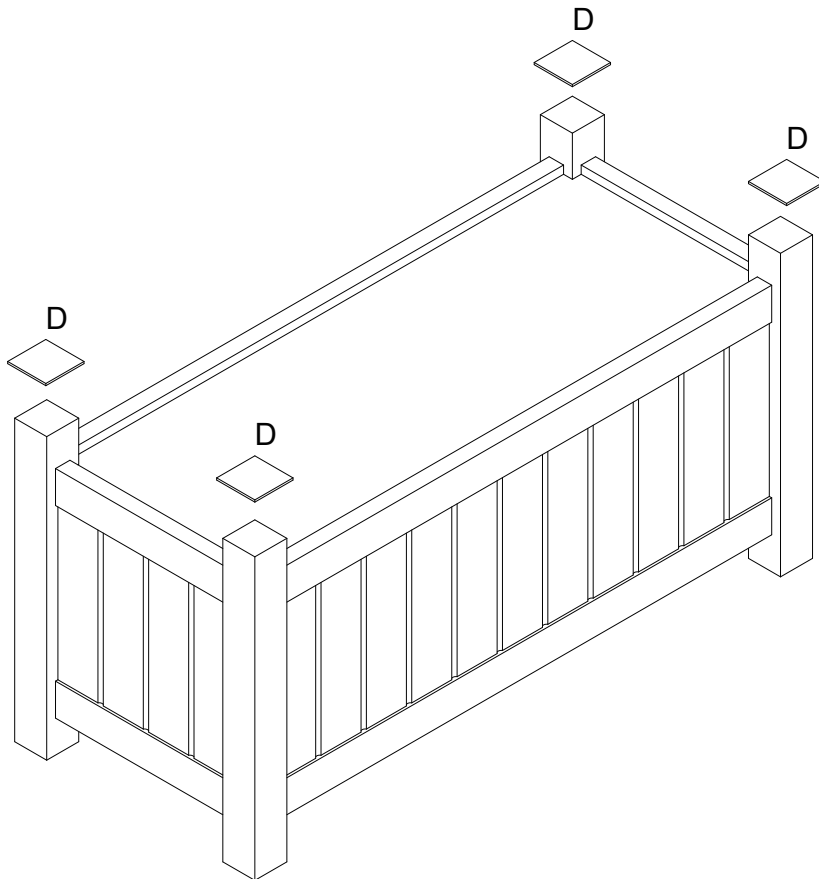

STEP 5

