

Assembly Instruction

43474226 ALMA DESK

CARE INSTRUCTIONS:

















WIPE CLEAN WITH A SOFT DAMP CLOTH. DO NOT USE ABRASIVE MATERIALS AND SOLVENTS. CHECK AND TIGHTEN ALL PARTS REGULARLY. DO NOT PLACE HOT ITEMS SUCH AS COFFEE CUPS DIRECTLY ON THE SURFACE. KEEP AWAY FROM WATER AND DIRECT SUNLIGHT. STORE IN A DRY PLACE. FOR DOMESTIC USE ONLY. FOR INDOOR USE ONLY. A MILD ODOUR MAY BE PRESENT WHEN FIRST OPENING THIS CARTON. SIMPLY ALLOW TO AIR OUTSIDE AND THIS WILL FADE.

WARNING:

DO NOT STAND OR SIT ON THIS UNIT. DO NOT USE THIS UNIT UNLESS ALL BOLTS AND SCREWS ARE FIRMLY SECURED. DO NOT KNOCK OR DRAG THIS UNIT. USE ONLY ON A FLAT SURFACE. LOAD TOP EVENLY TO PREVENT FROM TIPPING OVER. THIS PACKAGE CONTAINS SMALL PARTS AND SHARP POINTS. KEEP AWAY FROM CHILDREN AND BABIES. ADULT ASSEMBLY REQUIRED. FAILURE TO FOLLOW THESE WARNINGS COULD RESULT IN SERIOUS INJURY.

MAXIMUM SAFE LOAD: 30KGS FOR TOP, 3KGS FOR DRAWER.

Hardware List

	A	6x35mm	14pcs		I		24pcs
	B		14pcs		J		24pcs
	C	8x30mm	16pcs		K	4mm	1pc
	D	4x35mm	12pcs		L	6x12mm	6pcs
	E	3x12mm	16pcs		M	6x30mm	18pcs
 		300mm	2pcs		N		4pcs
 		300mm	2pcs		O	3x16mm	4pcs
	H	7x40mm	6pcs				

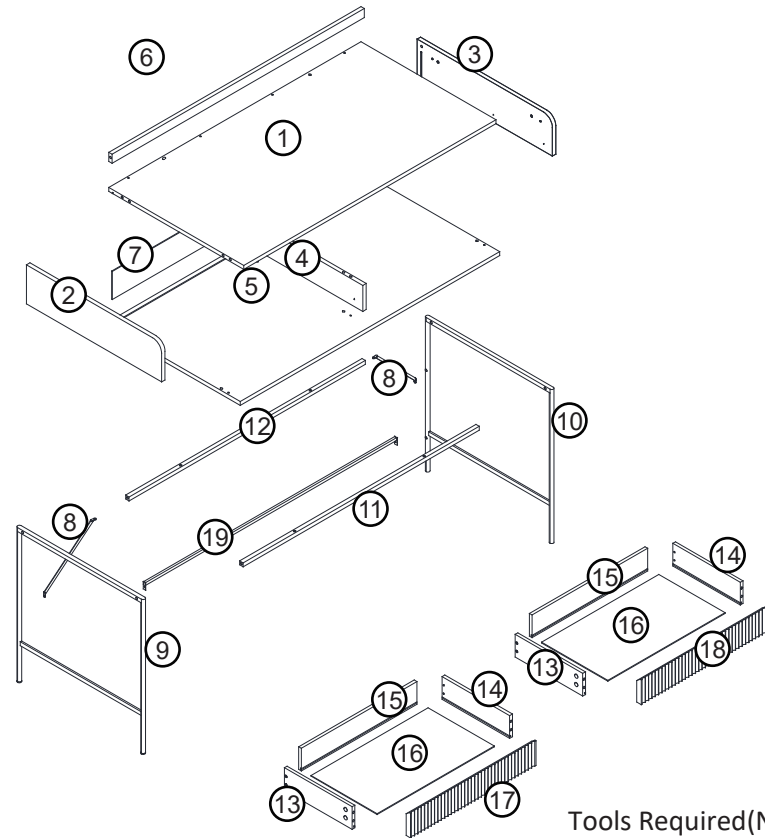
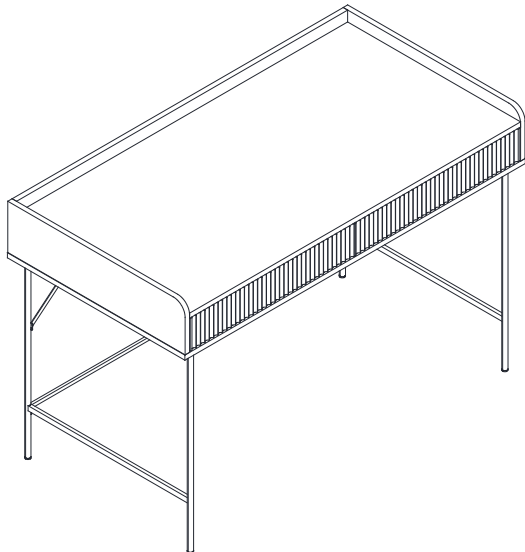

Tools Required (Not Provided)

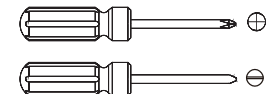



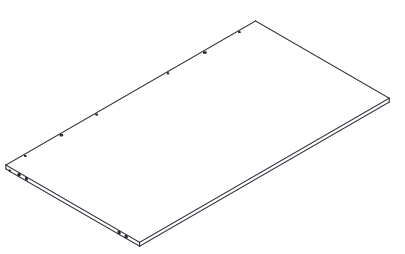
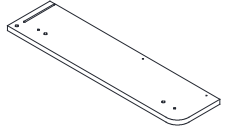
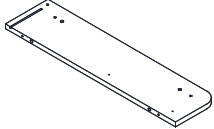
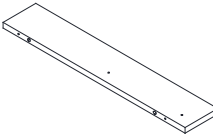
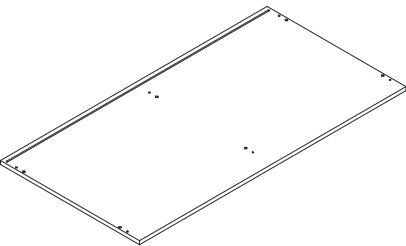
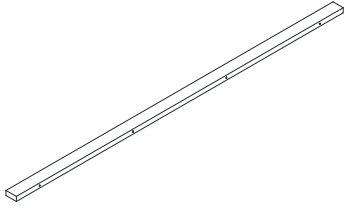
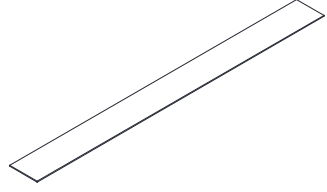
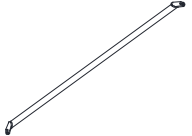
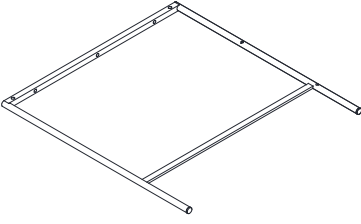
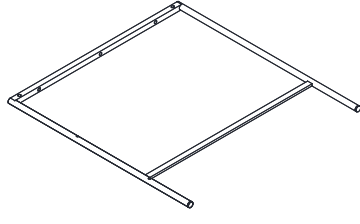
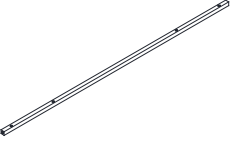
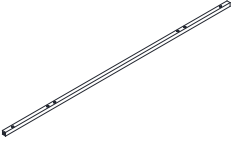
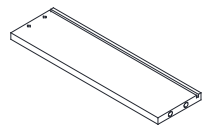
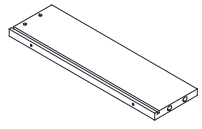
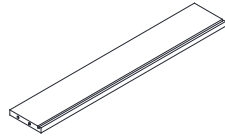
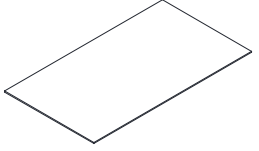
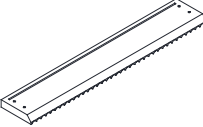
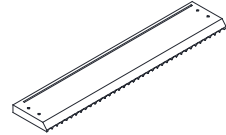
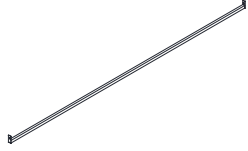

Do not tighten the screws fully during assembly.
Fully tighten screws after the final assembly steps.

Part List



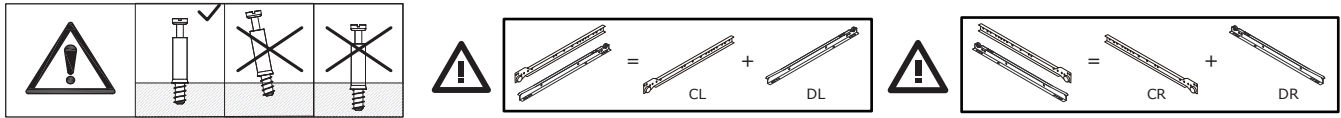
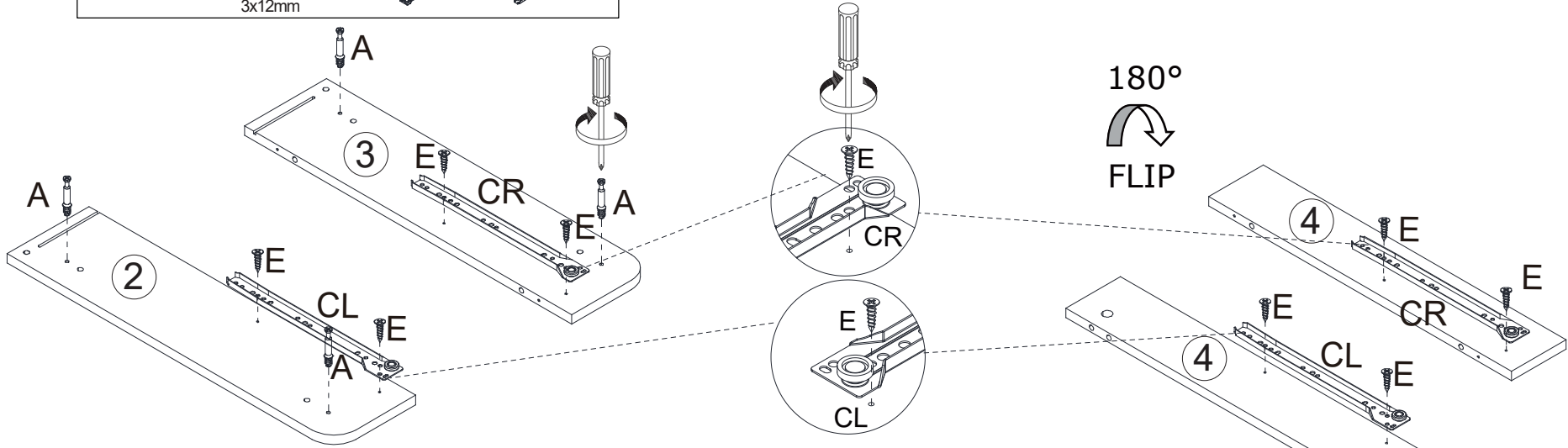

				
① 1 PC	② 1 PC	③ 1 PC	④ 1 PC	⑤ 1 PC
				
⑥ 1 PC	⑦ 1 PC	⑧ 2 PCS	⑨ 1 PC	⑩ 1 PC
				
⑪ 1 PC	⑫ 1 PC	⑬ 2 PCS	⑭ 2 PCS	⑮ 2 PCS
				
⑯ 2 PCS	⑰ 1 PC	⑱ 1 PC	⑲ 1 PC	

Step 1:

-  Ax4
-  Ex8 3x12mm
-  CLx2
-  CRx2



Step 2:

-  Ax2
-  Cx2
-  Cx2
-  Dx4 4x35mm

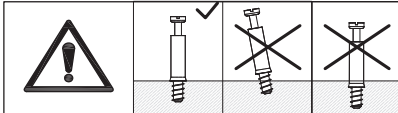
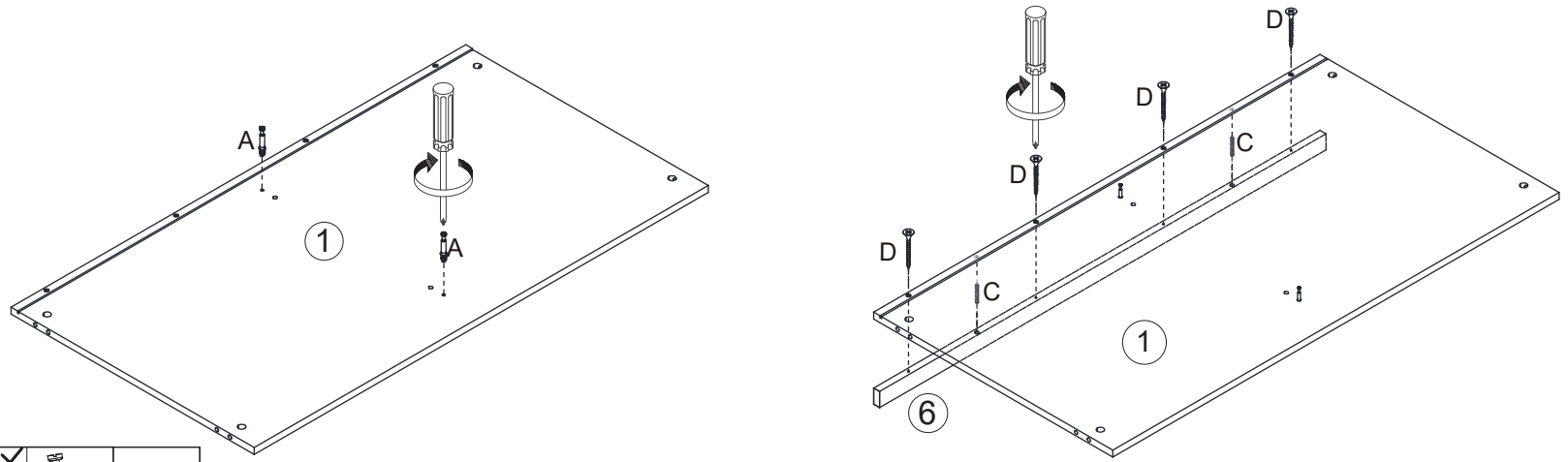

Step 3:

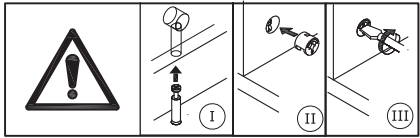
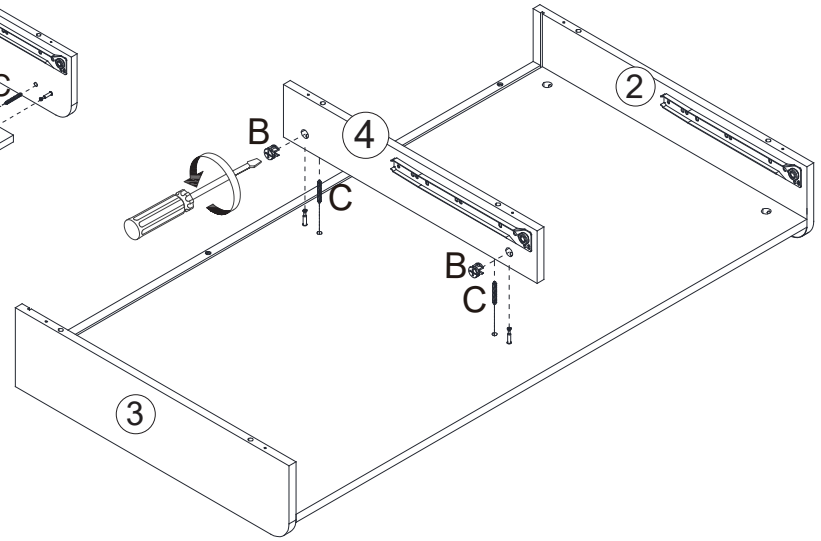
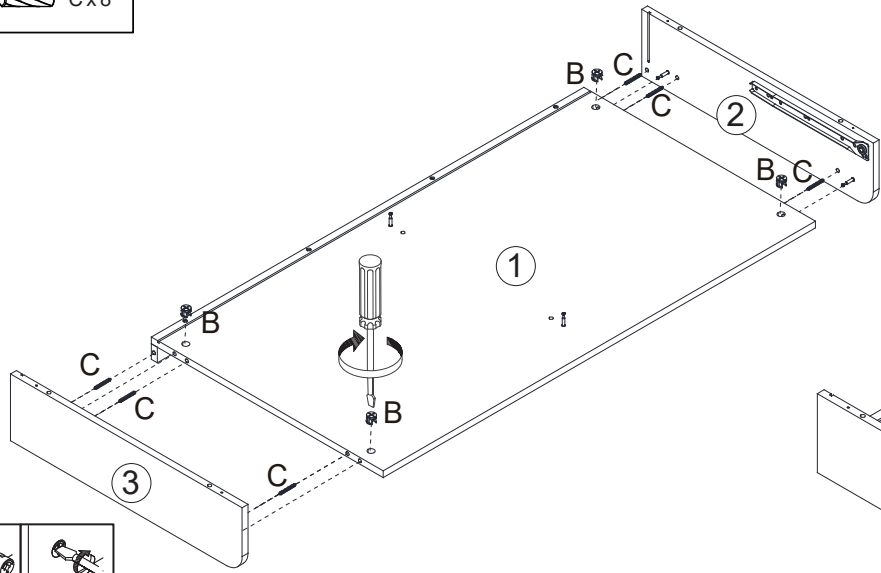
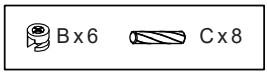

Step 4:

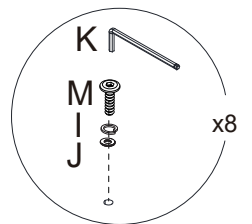
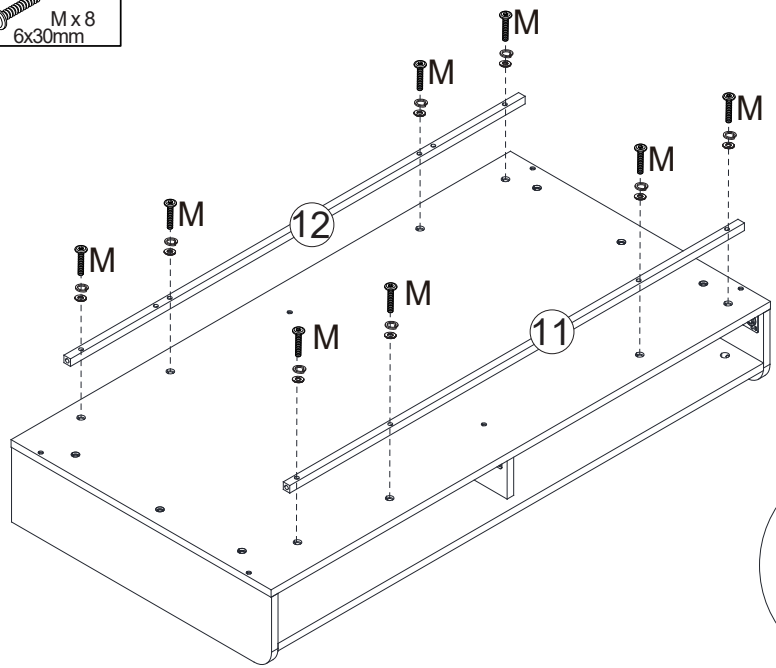
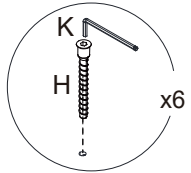
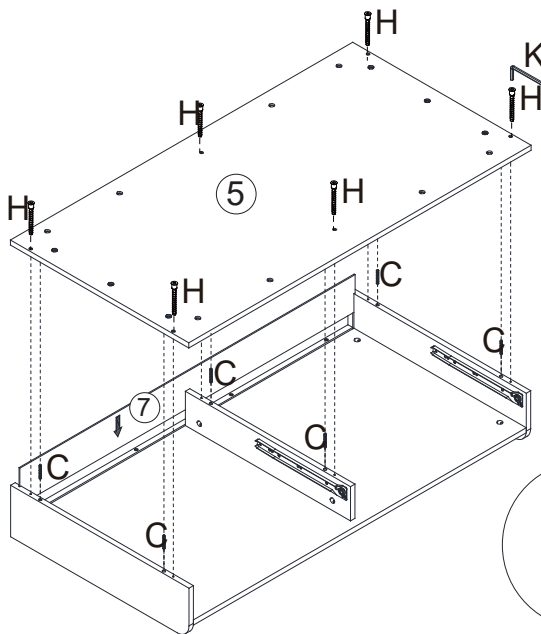

Step 5:

I x 16

J x 16

K x 1

L x 6
6x12mm

M x 10
6x30mm

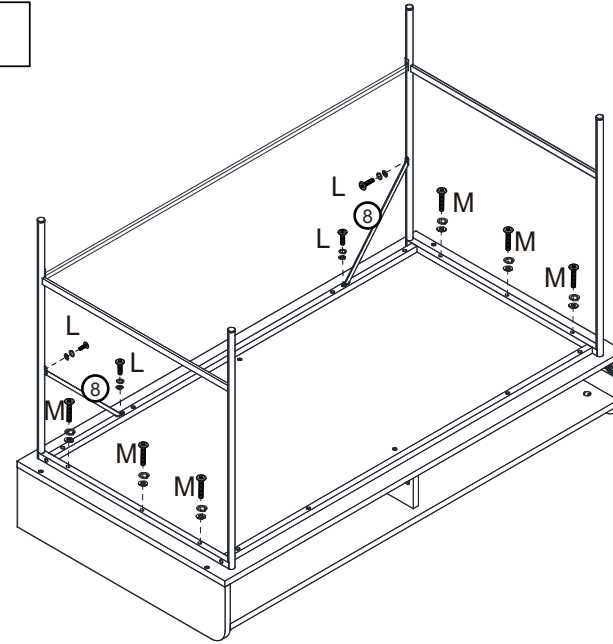
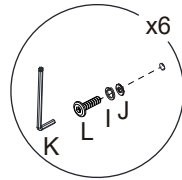
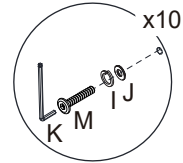
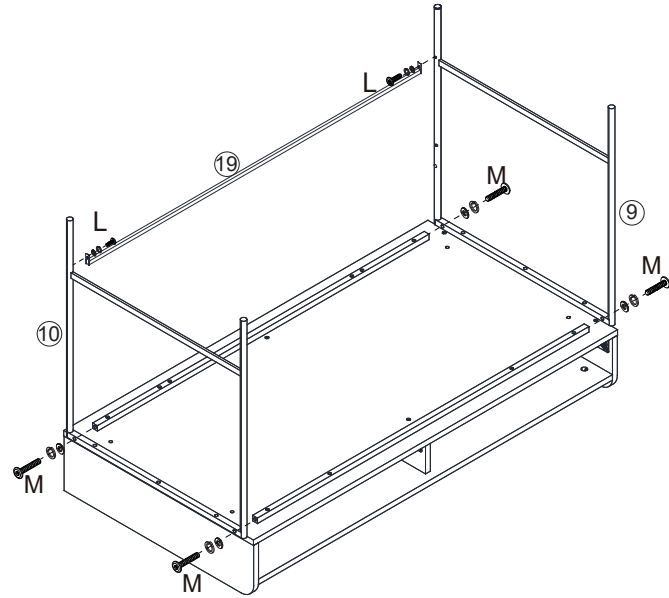

Step 6:

A x 4

B x 4

D x 4
4x35mm





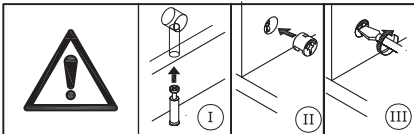
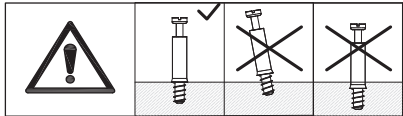
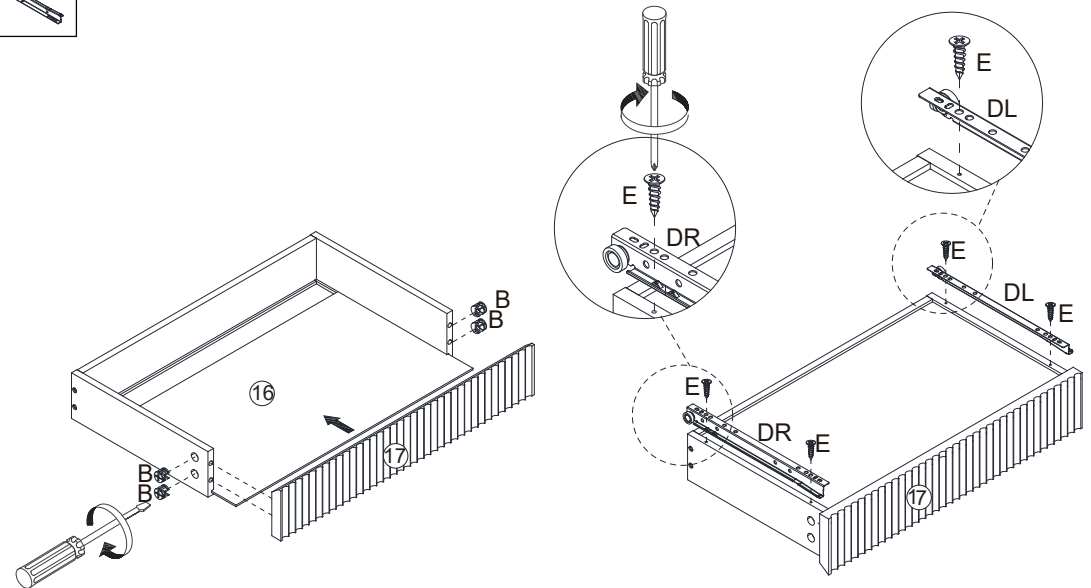
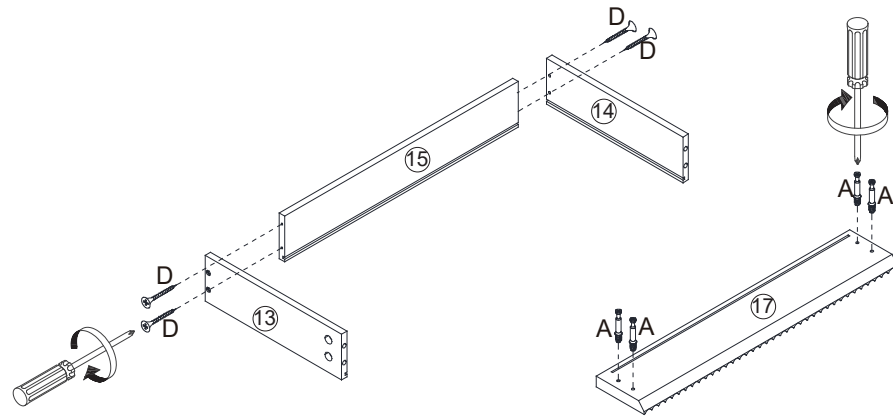

E x 4
3x12mm

DL x 1

DR x 1



Step 7:

 Ax4
  Bx4
  Dx4 4x35mm
  Ex4 3x12mm
  DLx1
  DRx1

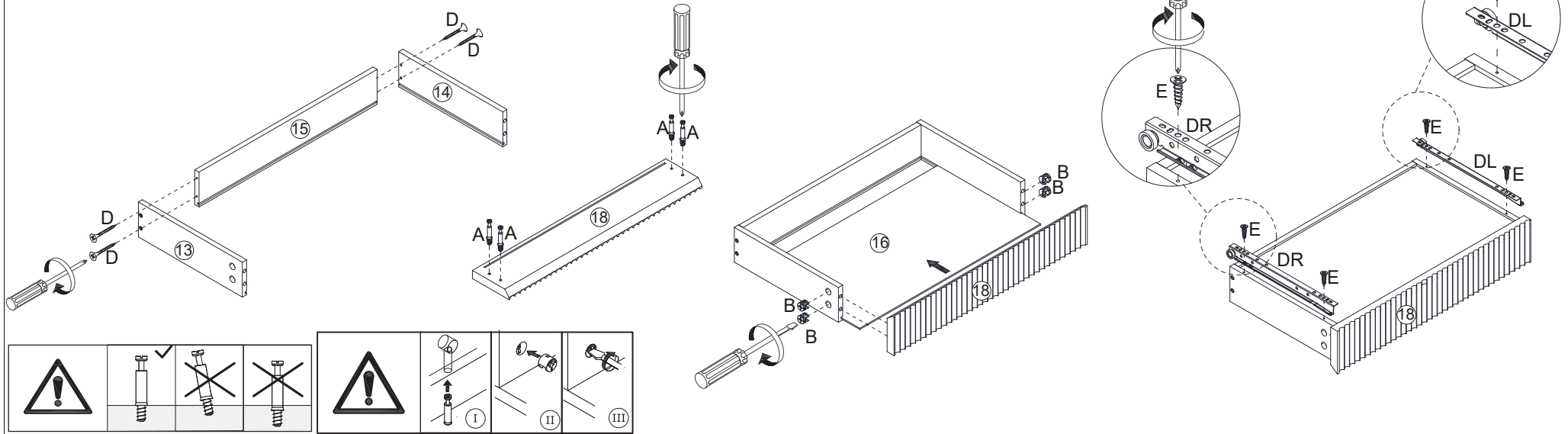

Step 8:

 Nx4
  Ox4 3x16mm

